

Important Collectors'
Motor Cars and Automobilia
13 July 2018
Goodwood Festival of Speed
Chichester, Sussex

GOODWOOD FESTIVAL OF SPEED SALE



Bonhams







GOODWOOD FESTIVAL OF SPEED SALE

Important Collectors' Motor Cars and Automobilia

Friday 13 July 2018 at 11:00 and 14:00

Chichester, Sussex

VIEWING

Thursday 12 July 10:00 to 17:30
Friday 13 July from 09:00

SALE

Friday 13 July
Automobilia 11:00
Vehicle Registration Numbers
immediately following automobilia
Motor Cars 14:00

SALE NUMBER

24876

CATALOGUE

£50.00 + p&p

REGISTRATION IMPORTANT NOTICE

Please note that all customers, irrespective of any previous activity with Bonhams, are required to complete the Bidder Registration Form in advance of the sale. The form can be found at the back of every catalogue and on our website at www.bonhams.com and should be returned by email or post to the specialist department or to the bids department at bids@bonhams.com

To bid live online and / or leave internet bids please go to www.bonhams.com/auctions/24876 and click on the Register to bid link at the top left of the page.

BIDS

+44 (0) 20 7447 7447
+44 (0) 20 7447 7401 fax
bids@bonhams.com

To bid via the internet please visit www.bonhams.com

Live online bidding is available for this sale
Please email bids@bonhams.com with "Live bidding" in the subject line 48 hours before the auction to register for this service.

Please note that bids should be submitted no later than 16:00 on Thursday 12 July. Thereafter bids should be sent directly to the Bonhams office at the sale venue. bids@bonhams.com

We regret that we are unable to accept telephone bids for lots with a low estimate below £500. Absentee bids will be accepted. New bidders must also provide proof of identity when submitting bids. Failure to do so may result in your bids not being processed.

IMPORTANT INFORMATION

The United States Government has banned the import of ivory into the USA. Lots containing ivory are indicated by the symbol Φ printed beside the lot number in this catalogue.

ENQUIRIES

Motor Cars
+44 (0) 20 7468 5801
+44 (0) 20 7468 5802 fax
ukcars@bonhams.com

Automobilia &
Vehicle Registration Numbers
+44 (0) 8700 273 619
automobilia@bonhams.com

SPECIALISTS

Tim Schofield
+44 (0) 20 7468 5804
tim.schofield@bonhams.com

Sholto Gilbertson
+44 (0) 20 7468 5809
sholto.gilbertson@bonhams.com

Rob Hubbard
+44 (0) 20 7468 5805
rob.hubbard@bonhams.com

John Polson
+44 (0) 20 7468 5803
john.polson@bonhams.com

Richard Stafford
+44 (0) 20 7468 5800
richard.stafford@bonhams.com

James Knight
+44 (0) 20 7447 7440
james.knight@bonhams.com

Malcolm Barber
+44 (0) 20 7 468 8238
malcolm.barber@bonhams.com

ENQUIRIES ON VIEW AND SALE DAYS

+44 (0) 8700 270 090
+44 (0) 8700 270 089 fax

CUSTOMER SERVICES

Monday to Friday 08:30 - 18:00
+44 (0) 20 7447 7447

Please see page 2 for bidder information including after-sale collection and shipment

Please see back of catalogue for important notice to bidders

ILLUSTRATIONS

Front cover: Lot 352
(© Tony Baker/Classic & Sportscar)
Back cover: Lot 370 (© Getty Images)

PLEASE NOTE

Admission to the auction marquee is by catalogue only.

This catalogue also admits two to the Goodwood Festival of Speed on the Bonhams auction and viewing days only, tickets are in the back of this auction catalogue.

However, if this catalogue has been obtained at the Goodwood Festival of Speed it will not have admission tickets included.

This catalogue does not admit the holder to the Festival of Speed on Saturday 14 July or Sunday 15 July.

Bonhams 1793 Limited

Registered No. 4326560
Registered Office: Montpelier Galleries
Montpelier Street, London SW7 1HH

+44 (0) 20 7393 3900
+44 (0) 20 7393 3905 fax

Bonhams International Board

Robert Brooks Co-Chairman,
Malcolm Barber Co-Chairman,
Colin Sheaf Deputy Chairman,
Matthew Girling CEO,
Patrick Meade Group Vice Chairman,
Jon Baddeley, Rupert Banner, Geoffrey Davies,
Jonathan Fairhurst, Asaph Hyman, James Knight,
Caroline Oliphant, Shahin Virani,
Edward Wilkinson, Leslie Wright.

Bonhams UK Ltd Directors

Colin Sheaf Chairman,
Harvey Cammell Deputy Chairman,
Antony Bennett, Matthew Bradbury,
Lucinda Bredin, Simon Cottle, Andrew Currie,
Jean Ghika, Charles Graham-Campbell,
Matthew Haley, Richard Harvey, Robin Herford,
David Johnson, Charles Lanning, Grant MacDougall

Gordon McFarlan, Andrew McKenzie,
Simon Mitchell, Jeff Muse, Mike Neill,
Charlie O'Brien, Giles Peppiatt, India Phillips,
Peter Rees, John Sandon, Tim Schofield,
Veronique Scorer, Robert Smith, James Stratton,
Ralph Taylor, Charlie Thomas, David Williams,
Michael Wynell-Mayow, Suzannah Yip.

General Information

Admission

Bonhams has the right at its sole discretion without assigning any reason therefore to refuse admission to its premises or attendance at any of its sales by any person.

Absentee Bids

Bonhams will execute bids when instructed. Lots will be bought as cheaply as is allowed by other bids and Reserves.

References

Intending Buyers should supply bankers' references. The references should be supplied to Bonhams in time to allow them to be taken up before the Sale. Unless arrangements are made with Bonhams for payment in advance of the Sale all Lots will be removed to storage immediately after the Sale at the Buyers' cost. In any event, the Purchase Price should be paid to Bonhams not later than 12 noon on the day after the Sale. Attention is specifically drawn to Condition 6 of the Buyers' Agreement as printed in this Catalogue.

Bidder Registration

To recognise bidders during the Sale all intending Buyers are required to complete a Bidder Registration Form giving full identification and appropriate references before the Sale which will enable them to bid by means of a number allocated to them.

Premium

Like the vast majority of auctioneers Bonhams charge what is known as a Buyer's Premium on the Hammer Price of each Lot purchased and is subject to VAT. Some lots may also be subject to VAT on the Hammer Price and these lots will be clearly marked with a symbol (†, Ω, *) printed beside the lot number in the catalogue.

For Automobilia the Buyer's Premium is 25% on the first £175,000 of the Hammer Price, 20% from £175,001 to £3,000,000 of the Hammer Price, and 12.5% on the balance thereafter.

For Motor Cars and Vehicle Registration Numbers the Buyer's Premium will be 15% on the first £50,000 of the Hammer Price of each Lot, and 12% on the balance thereafter.

Buyers' attention is drawn to Condition 7 of the Notice to Bidders. VAT at the standard rate is payable on the Premium by all Buyers, unless otherwise stated.

Damage

Any viewer who damages a Lot will be held liable for all damage caused and shall reimburse Bonhams or its agents for all costs and expenses relating to rectification of such damage.

NOVA (Notification of Vehicle Arrivals)

Certain imported Motor Car and Motorcycle Lots marked "N" in the catalogue are subject to a NOVA Declaration prior to the purchaser making an application to register the vehicle in the UK with the DVLA.

EU Imports

- Bonhams will undertake the NOVA Declaration on the purchaser's behalf, providing them with a NOVA reference number.

Successful purchasers should contact the Mark Gold post-sale to confirm whether they intend to register the vehicle in the UK, or intend to Export the vehicle immediately

Non-EU Imports

- If the Lot is purchased by a private purchaser wishing to register in the UK, Bonhams will undertake the NOVA Declaration on the purchaser's behalf, providing them with both a NOVA reference number and stamped C88 form.
- If the Lot is purchased by a trade buyer / company, Bonhams will provide the purchaser with a stamped C88, though they will need to submit a NOVA Declaration themselves via: www.gov.uk/nova-log-in. N.B: Bonhams takes no responsibility for a purchaser's failure to submit a NOVA Declaration and any fines / charges levied against them as a result.

Methods of Payment

It is important you are aware of the following regarding registration and payment:

The name and address in which you register will be the name and address on your invoice, if successful. We cannot amend the details on your invoice, once issued. Furthermore, when making payment, the account from which the payment is sent must match the buyer's details as per on the bidder registration form and the issued invoice.

We are unable to accept any third party payments. Should a third party payment be made this will result in a delay in your payment being processed and your ability to collect your purchase.

Purchases can only be released when full settlement (inclusive of all charges) of all invoices issued to the buyer is received in cleared funds. Before bidding, you should ensure that you have the necessary funds available and be able to pay according to one of the methods set out below. All cheques should be made payable to Bonhams 1793 Limited.

Bonhams' preferred payment method is by bank transfer. You may electronically transfer funds to our Trust Account. If you do so, please quote your paddle number and invoice number as the reference. Our Trust Account details are as follows:

- **Bank Transfer:** You may electronically transfer funds to our Trust Account. Please quote your paddle number and Invoice number as the reference. Our Trust Account details are as follows.
Bank: National Westminster Bank Plc
Address: PO Box 4RY
250 Regent Street
London W1A 4RY
Sort Code: 56-00-27
Account Name: Bonhams 1793 Limited Client Bank Account
Account Number: 25563009
IBAN Number: GB 33 NWBK 560027 25563009

If paying by bank transfer, the amount received after the deduction of any bank fees and/or conversion of the currency of payment to pounds sterling must not be less than the sterling amount payable, as set out on the invoice. Payment may also be made by one of the following methods:

- **Cash:** You may pay for Lots purchased by you at this Sale with notes or coins in the currency in which the Sale is conducted (but not any other currency) provided that the total amount payable by you in respect of all Lots purchased by you at the Sale does not exceed £3,000, or the equivalent in the currency in which the Sale is conducted, at the time when payment is made. If the amount payable by you for Lots exceeds that sum, the balance must be paid otherwise than in coins or notes; this limit applies to both payment at our premises and direct deposit into our bank account.

- **Card:** Debit issued by Visa and MasterCard only. There is no limit on payment value if payment is made in person using Chip & Pin verification.

Payment by telephone may also be accepted up to £5,000, subject to appropriate verification procedures, although this facility is not available for first time buyers. If the amount payable by you for Lots exceeds that sum, the balance must be paid by other means.

Credit cards issued by Visa and MasterCard only. There is a £5,000 limit on payment value if payment is made in person using Chip & Pin verification. It may be advisable to notify your debit or credit card provider of your intended purchase in advance to reduce delays caused by us having to seek authority when you come to pay.

Note: only one debit or credit card may be used for payment of an account balance. If you have any questions with regards to card payments, please contact our Customer Services Department.

- **Cheque:** You may pay by sterling cheque drawn on a UK bank or building society but all cheques must be cleared before you can collect your purchases, unless you have a cheque facility with Bonhams or we have received an assurance directly from your bank prior to the sale. Cheques generally take up to 10 working days to clear.

Vehicles imported under Temporary Admission (TA)

Please note vehicles under TA (marked with either an Ω or a *) may not be available for registration with DVLA for up to 15 working days after the sale. This time may be reduced to 48 hours for an additional charge of £75 per vehicle.

VAT

The following symbols are used to denote that VAT is due on the hammer price and buyer's premium:
† VAT at 20% on hammer price and buyer's premium
Ω VAT on imported items at 20% on hammer price.
* VAT on imported items at 5% on hammer price.

- Zero rated for VAT, no VAT will be added to the hammer price or the buyer's premium.

In all other instances no VAT will be charged on the hammer price, but VAT at the prevailing rate (currently 20%) will be added to the buyer's premium which will be invoiced on a VAT inclusive basis.

Vintage Sports-Car Club Eligibility Documents

Any eligibility document issued to the owner of a car is merely to certify that the vehicle is eligible to compete in VSCC events on the basis of the rules and regulations currently in force. It is not intended to be used for any trade or commercial purposes. It does not provide any guarantee as to the standard of design, manufacture, condition or its authenticity, provenance or history. VSCC eligibility documents lose validity on transfer of ownership of the vehicle and a new application is therefore required.

The Veteran Car Club of Great Britain Dating Plates and Certificates

When mention is made of a Veteran Car Club Dating Plate or Dating Certificate in this Catalogue, it should be borne in mind that the Veteran Car Club of Great Britain using the services of Veteran Car Company Ltd, does from time to time, review cars already dated and, in some instances, where fresh evidence becomes available, the review can result in an alteration of date. Whilst the Club and Veteran Car Company Ltd make every effort to ensure accuracy, the date shown on the Dating Plate or Dating Certificate cannot be guaranteed as correct and intending purchasers should make their own enquiries as to the date of the car.

Guide for Buyers

Do I need to bring my catalogue to the sale?

Yes. Please ensure that you bring your catalogue to the sale as entry is by catalogue only. Each catalogue allows two people entry on the view and sale days. Further copies of the catalogue can be purchased at the sale venue.

How do I bid at the sale?

In order to bid at the sale you will be required to complete a bidder registration form, and provide identification, photographic (passport or driving licence) and address (utility bill/bank statement). In addition for a company registration please provide a copy of the Certificate of Incorporation plus proof of address.

For Lots 330, 335 and 352 you may also be asked to provide a suitable bank reference. If you do not, at our request, provide us with a bank reference, or if the reference is not acceptable to us, you may be issued with a paddle that does not allow you to bid on these Lots.

We recommend prospective buyers to register as early as possible after receiving their catalogue or viewing it on line. It is likely to take several business days for a bank to issue an acceptable reference to us.

Should you be unable to attend the sale but still wish to bid, you can either leave an absentee or telephone bid. These forms can generally be found at the back of the sale catalogue.

Telephone bidding

Telephone bidding allows you to bid live as the auction is happening. You will need to complete a form which asks for your name, address, the telephone number(s) you wish us to contact you on (it is advisable to add an additional number such as your mobile) and the lot number(s) you wish to bid on. For any reason we are unable to contact you on the telephone number(s) you leave on the form, please ensure that the highest bid column is completed (optional). A member of Bonhams staff will contact you a few lots prior to the lot(s) you wish to bid on and you will be instructed from there on. Please note that we do not operate telephone bids for lots with a low estimate below £500.

Absentee/Commission bidding

As with telephone bidding, you will need to complete a form with your name, address and the lot(s) number(s) you wish to bid on. You will also need to enter the amount you are willing to bid up to for that lot (excluding premium & VAT). Bonhams will execute the bid as cheaply as possible on your behalf.

Please ensure the form is signed and dated at the bottom and disregard the client and paddle no. fields at the top of the form as this is for Bonhams use only. Once the form is completed you can either fax or post it back to our offices. Should you post the form back to our offices, please ensure it is posted in ample time prior to the sale day. If you are a first time bidder you must also provide proof of identity. This can be either a copy of your passport or driving licence. This must be sent at the same time as your bidding form.

In order for the above forms to be accepted they have to be completed with buyer's details, lot number(s), signed, contain credit/debit card details and fax/post to us no later than the morning of the sale day.

How fast will the auctioneer go?

The auctioneer will aim to sell +/- 60 lots of automobilia per hour and circa 30 vehicles per hour.

Can I view the files that accompany the vehicles?

Yes, we should have every vehicles file available for inspection during the view. Each motor car's registration document (V5C), is held within a separate file at the documents desk during the auction. To view this document please ask a member of staff

Keys and Documents

Vehicles are offered with and without keys and documents. It is the buyers responsibility to inspect the lot at the sale to satisfy oneself as to the completeness, integrity and presence of keys, spares and documentation. The catalogue will not necessarily list such said items.

Are there any warranties offered with the vehicles?

No. All vehicles are offered on an 'as seen' basis. It is wise if possible to bring a professional mechanic with you to fully inspect the vehicles. It is also advised that the vehicles is checked before road use. The fully illustrated catalogue will describe the vehicles to the best of our ability on information supplied. Should we receive pertinent information after the publication of the catalogue, we shall affix what is known as a sale room notice (SRN) to the vehicle. A list of all SRNs will be available by the time the vehicles are presented for view. We are happy to offer our opinion as to the integrity of the vehicle at the sale, however you should accept this is an opinion only and should not be relied upon. In short, you should satisfy yourself as to the completeness, condition and integrity of any lot prior to bidding. It is also important to note that some illustrations are historical and may show the vehicle in a better condition than now offered.

Can I change my mind after I have purchased a lot?

No. Lots are not sold as an option and there is no 'cooling off' period. Once the auctioneer drops the hammer a contract is made and you are obligated to proceed with said contract.

Important changes to V5C Registration Document procedures

Please note that Bonhams retain and update all registration documents, therefore please make sure if you are a successful bidder you fill in the registration document on the day of the sale, with the name and address for which the vehicle is to be registered to.

In order to comply with the Driver and Vehicle Licensing Authority's (DVLA) procedures for updating a change of keeper for a motor vehicle, Bonhams has now changed their policy on the handling of V5C Registration documents, upon full payment by the buyer.

If we have not received confirmation of the new keeper's name and address 14 days from the date of the sale, we will write to you requesting this information.

If, after 28 days from the date of sale, we still have not had contact from you, we will update the new keeper to the name and address shown on your Bonhams client account.

Should your address be from outside the United Kingdom, we will inform the DVLA that the vehicle has been exported.

If you wish the new keeper details to be updated in any other way please make contact with the Sale Administrator as soon as possible.

Please Note: Once the V5C has been updated by the DVLA it cannot be reversed.

All registration document enquiries should be directed to Harriet Gillett/Mark Gold

How can I pay?

It is important you are aware of the following regarding registration and payment:

The name and address in which you register will be the name and address on your invoice, if successful. We cannot amend the details on your invoice, once issued.

Furthermore, when making payment, the account from which the payment is sent must match the buyer's details as per on the bidder registration form and the issued invoice.

We are unable to accept any third party payments. Should a third party payment be made this will result in a delay in your payment being processed and your ability to collect your purchase.

We accept the following methods of payment.

Bank transfer

Our bank details can be found on the general information page. Please quote your client number and invoice number as the reference. If paying by bank transfer, the amount received after either the deduction of bank fees or for the conversion to pounds sterling, must not be less than the sterling amount payable on the invoice

Payment by card

Debit issued by Visa and MasterCard only. There is no limit on payment value if payment is made in person using Chip & Pin verification.

Payment by telephone may also be accepted up to £5,000, subject to appropriate verification procedures, although this facility is not available for first time buyers. If the amount payable by you for Lots exceeds that sum, the balance must be paid by other means.

Credit cards issued by Visa and MasterCard only. There is a £5,000 limit on payment value if payment is made in person using Chip & Pin verification. It may be advisable to notify your debit or credit card provider of your intended purchase in advance to reduce delays caused by us having to seek authority when you come to pay.

Note: only one debit or credit card may be used for payment of an account balance. If you have any questions with regards to card payments, please contact our Customer Services Department.

Payment by cheque

You may pay by sterling cheque but all cheques must be cleared before you can collect your purchases, unless you have a cheque facility with Bonhams or we have received an assurance directly from your bank prior to the sale. Cheques generally take up to 10 working days to clear.

We are happy to accept cash (in the currency in which the sale is conducted) but not to exceed £3,000. Any amount over £3,000 must be paid otherwise than in coins or notes.

Are there any other charges?

Like the vast majority of auctioneers Bonhams charge what is known as a Buyer's Premium on the Hammer Price of each Lot purchased and is subject to VAT. Some lots may also be subject to VAT on the Hammer Price and these lots will be clearly marked with a symbol (†, Ω, *) printed beside the lot number in the catalogue.

For Automobilia the Buyer's Premium is 25% on the first £175,000 of the Hammer Price, 20% from £175,001 to £3,000,000 of the Hammer Price, and 12.5% on the balance thereafter. Storage and handling charges may also be payable by the Buyer as detailed on the specific "Collections" page.

For Motor Cars and Vehicle Registration Numbers the Buyer's Premium will be 15% on the first £50,000 of the Hammer Price of each Lot, and 12% on the balance thereafter.

Buyers' attention is drawn to Condition 7 of the Notice to Bidders. VAT at the standard rate is payable on the Premium by all Buyers, unless otherwise stated.

When can I clear my purchases?

Once full payment has been received, purchases can be cleared (where possible) during and immediately after the auction. All unpaid and uncollected lots of Automobilia will be removed to Bonhams' Warehouse at 6pm on the day of sale. Vehicles will be uplifted the night of the sale to local store, clients will be given the address when collecting their invoices or paying for their purchases following the sale.

N.B. Clients cannot pay for purchases on Saturday 14 or Sunday 15 July at the local store.

Payment can be taken between 9am and 12pm on Monday 16 July at which point all remaining unpaid lots will be uplifted by Polygon to their storage facility.

Can someone deliver the vehicle for me?

Bonhams do not transport vehicles. However, representatives from our preferred carriers - Polygon Transport - are present at every sale and can quote a price to deliver the vehicle to you. Polygon's contact details are listed in the sale catalogue.

If you are unable to attend the sale, please contact Bonhams as soon as possible post-sale with the correct name and address. For motor car registration please contact the department.

BONHAMS MOTORING INTERNATIONAL SPECIALIST TEAM

UNITED KINGDOM



Tim Schofield



Sholto Gilbertson



Rob Hubbard



John Polson



Richard Stafford



Jamie Knight



Malcolm Barber

EUROPE



Philip Kantor



Gregory Tuytens



Paul Gaucher



Gregor Wenner

WEST COAST USA



Jakob Greisen



Mark Osborne



Michael Caimano



Derek Boycks

EAST COAST USA



Rupert Banner



Eric Minoff



Evan Ide



Greg Porter



Tim Parker

ADDITIONAL CONTACTS

Automobilia

Toby Wilson
+44 (0) 20 8963 2842
toby.wilson@bonhams.com

Adrian Papiro
+44 (0) 20 8963 2840
adrian.papiro@bonhams.com

Business Manager

Mark Gold
+44 (0) 20 7468 5807
mark.gold@bonhams.com

Motor car Administrator

Harriet Gillett
+44 (0) 20 7468 5806
harriet.gillett@bonhams.com

Motorcycle Department

Ben Walker
+44 (0) 20 8963 2819
ben.walker@bonhams.com

James Stensel
+44 (0) 20 8963 2818
james.stensel@bonhams.com

Bill To
+44 (0) 20 8963 2822
bill.to@bonhams.com

Motorcycle Administrator

Kristi Lavis
+44 (0) 20 8963 2817
kristi.lavis@bonhams.com

Press Office

Poppy McKenzie Smith
+44 (0) 20 7468 5870
+44 (0) 20 7468 8209 fax

Motor Car Presentation

Chris Bailey, Showcase SVS
+44 (0) 7889 722 333

Catalogue subscriptions

+44 (0) 1666 502 200
+44 (0) 1666 505 107 fax
subscriptions@bonhams.com

Buyers/Sellers Accounts UK

Cheryl Uggles
+44 (0) 20 7468 8292
+44 (0) 20 7447 7430 fax

Buyers/Sellers Accounts US

+1 (415) 861 7500
+1 (415) 861 8591 fax

Collections

Automobilia

All purchased lots must be collected from the sale venue by 6pm on the day of sale. All un-collected purchased lots shall then be removed to Bonhams Guildford office at the buyers expense.

Bonhams Guildford office located at:
4 Millmead Guildford, GU2 4BE

Uncollected lots will be available for collection **by appointment only** from Tuesday 17 July 2018

To arrange collection please contact the Automobilia Department
020 8963 2840 or automobilia@bonhams.com

All lots will be charged £10 + VAT uplift and storage at £1 + VAT per day per lot.

All lots marked with a ◊ will be charged £25 + VAT uplift and storage at £5 + VAT per day per lot.

All lots marked with a ◊◊ will be charged £50 + VAT uplift and storage at £10 + VAT per day per lot.

All lots marked with a ◊◊◊ will require specific shipping and storage arrangements, as they are either extremely large or heavy objects.

Shippers or Agents wishing to collect on behalf of the purchaser must provide written instruction from the client before Bonhams will release the lot(s). All purchases are at buyers risk from the fall of the hammer.

Motor Cars

Vehicles must be collected from the sale venue on the evening of the day of the sale. After this cars are moved to local store where they need to be collected by 12 noon on Monday 16 July. (Please see Guide for Buyers)

Buyers should satisfy themselves that they have collected all relevant log books, documents, parts and keys relating to their Lot(s) at time of collection. **Otherwise Lots shall be removed to storage at the Buyer's expense (see below).** Lots are at the Buyer's risk from the fall of the hammer. It is strongly advisable that overseas purchasers and absentee bidders make arrangements regarding collection with Bonhams in advance of Sale.

Removal and Storage of Vehicles

All Lots not removed in accordance with the above will be transported by Bonhams to Polygon Transport Store:

Polygon Transport
Unit 2H North Road
Marchwood Industrial Park
Normandy Way
Marchwood, Southampton
Hants SO40 4BL
02380 871 555
02380 862 111 fax
polygon@polygon-transport.com

Vehicle Removal charges

£260 + VAT per vehicle

Vehicle Storage charges

First 14 days
£20 + VAT per motor car per day

Thereafter

£10 + VAT per motor car per day

Transport and Shipping

A representative of Polygon Transport, will be at the Sale and can arrange national and international transportation as agent for the Buyer or the Seller (as the case may be).

Transporter

Polygon Transport
Unit 2H North Road
Marchwood Industrial Park
Normandy Way
Marchwood, Southampton
Hants SO40 4BL
02380 871 555
02380 862 111 fax
polygon@polygon-transport.com

Motor Car Presentation

Chris Bailey, Showcase SVS
+44 (0) 7889 722 333
www.showcasesvs.co.uk

Photography

Simon Clay
Tom Wood
Neil Fraser
Marc Wilmot
Daniele Turetta
Roger Dixon (Automobilia)

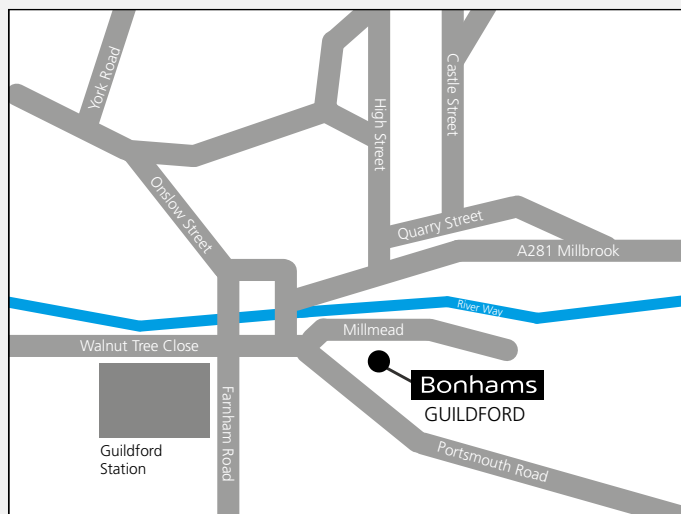

Directions to Goodwood

Goodwood House
Chichester
West Sussex
PO18 0PX

On Thursday and Friday Bonhams clients should approach Goodwood House and they will then be directed into the public car parks for the Moving Motor Show and Festival of Speed. Please ensure you give yourself adequate time to get from the public car parks to the Bonhams sale marquee.

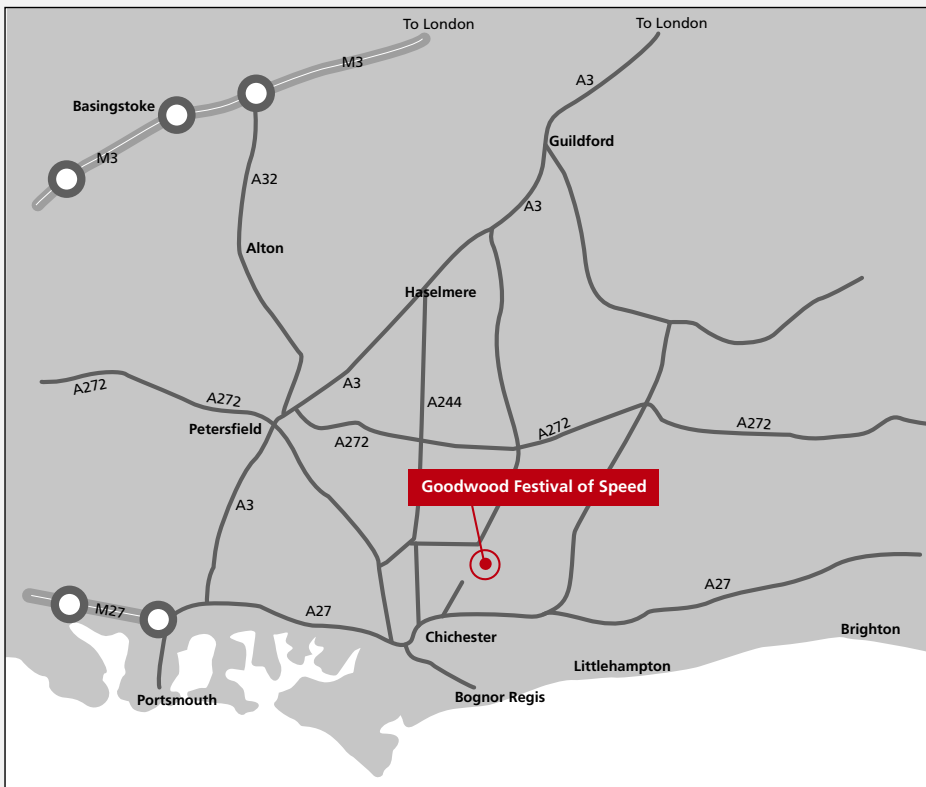

AUTOMOBILIA

11:00am

Lots 1 - 170

VEHICLE REGISTRATION NUMBERS

Lots 201 - 210

Images of each lot can be found at:
www.bonhams.com/24876



TIM LAYZELL



3



4



1



2

1

A SIGNED PHOTOGRAPH OF JUAN MANUEL FANGIO,
colour portrait image depicting the racing driver in race helmet with goggles, signed in blue ink by Fangio, 30 x 19cm, mounted, framed and glazed.

£1,000 - 1,500
€1,100 - 1,700

2

A FRAMED PHOTOGRAPH OF GRAHAM HILL IN THE LOTUS 59B,

monochrome image depicting Hill in the Formula 2 Winkelmann Racing Lotus, 21 x 29cm, double-mounted within presentation frame and signed in pencil by Damon Hill to the mount.

£1,000 - 1,200
€1,100 - 1,400

3

AFTER FABIEN FABIANO (1883-1962), A RARE 'MICHELIN ENVELOPPE VELO' ADVERTISING POSTER, FRENCH, 1916,

printed in full colour on paper by Chaix of Paris, depicting Mons. Bibendum and a well dressed young lady showing Michelin tyres and inner tubes, 119 X 76cm, laid on linen, with two French poster tax paid stamps.

£1,500 - 2,000
€1,700 - 2,300



5

4

AFTER H. L ROOWY 'LE MEILLEUR. LE MOINS CHER. PNEU VELO MICHELIN' ADVERTISING POSTER, 1912,

printed in full colour on paper by Chaix of Paris, with lettering to lower edge for M. Tabareau Cycles - Jupilles, 117 x 76cm, laid on linen, some evidence of minor old repairs and restoration to lower edge, with French poster tax paid stamp.

£1,200 - 1,600
 €1,400 - 1,800

5

A RARE PAIR OF SIGNED AND ANNOTATED 1938 INTERNATIONAL DONINGTON GRAND PRIX POSTERS,

for both the cancelled race (1 October 1938) and the rescheduled race (22 October 1938), with artwork after Frederick Gordon Crosby, printed in green and black (1 Oct) and red and black (22 Oct), on paper 77 x 49cm, each with many signatures of driver's who raced including Billy Cotton, Ian Connell, Percy McLure and Arthur Dobson, other signatures include Mort

Morris-Goodall 'Mad Jack' O'Connell and a few fabricated names including "Rudi von Schwanzengruber Schitzonfartz", further annotations relating to the political situation, racing drivers poking fun at each other including the oil spill from Hanson's Alta that caused so many of the front runners to come off the track at the hairpin and further annotations relating to drinking. The 1 October poster has been altered to read "Drinkington G.P. held at The Royal, ASHBY" with the start time altered to read "Drinking Commences 1pm".

(2)
 £1,200 - 1,500
 €1,400 - 1,700

In early September 1938 at his annual Nuremburg Rally Adolf Hitler precipitated a crisis over the Sudeten lands of Czechoslovakia, which he claimed as German. On September 23rd the Czechs mobilised their armed forces. For a week Europe was on the brink of war, but on the night of the September 29th, two days after Britain mobilised its fleet, an agreement

was signed in Munich. Prime Minister Neville Chamberlain flew home proclaiming 'Peace in our time'.

The Donington GP had been scheduled for October 1 but the crisis forced a postponement, so that the teams did not gather until the 22nd. A poster was re-issued with the new date, but most of the race programs had the date changed by hand on the front cover.

The Germans came in force with Mercedes-Benz fielding Seaman, Von Brauchitsch, Lang and youngster Walter Baumer and Auto Union entering Nuvolari, Muller and Hasse, French Champion Rene Dreyfus arrived in a Delahaye and the field was completed by an assortment of British machinery and drivers. The race was won by Tazio Nuvolari in his D type Auto Union in a time of 3 Hours 6 minutes and 22 seconds.

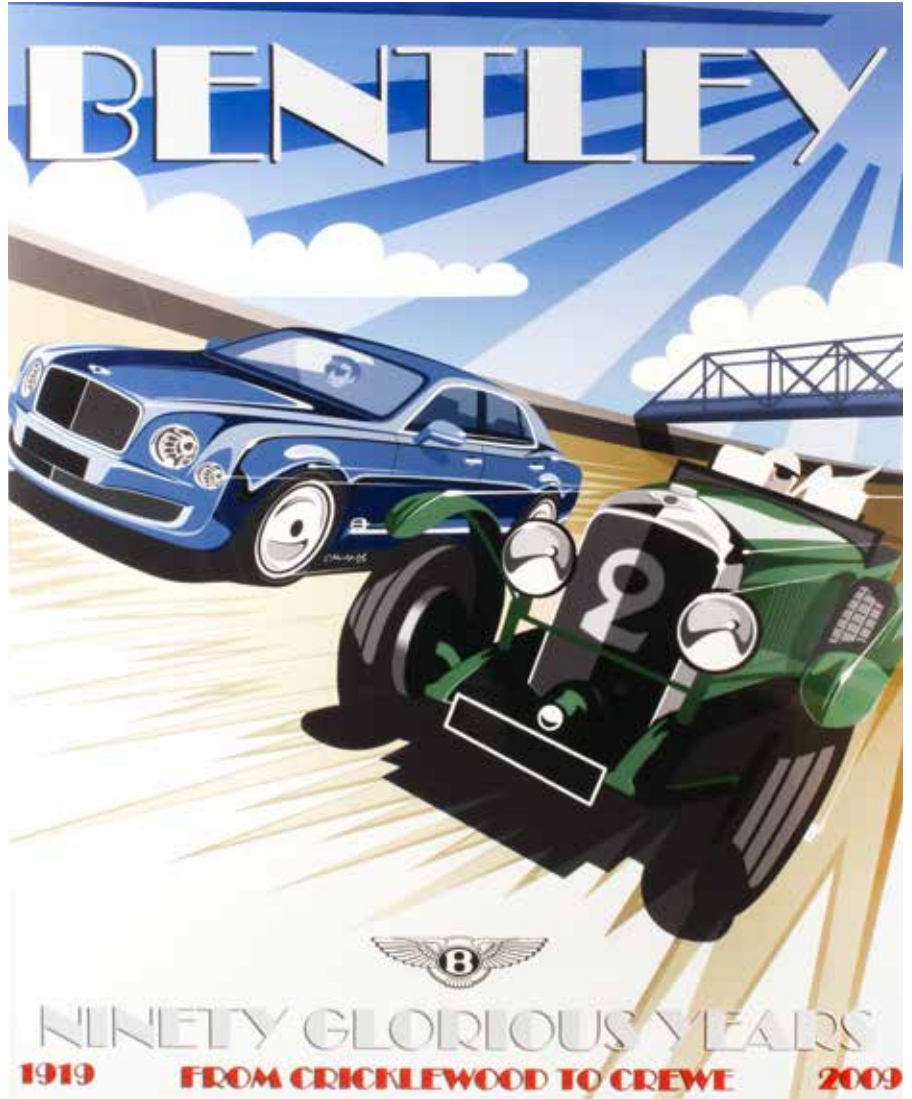
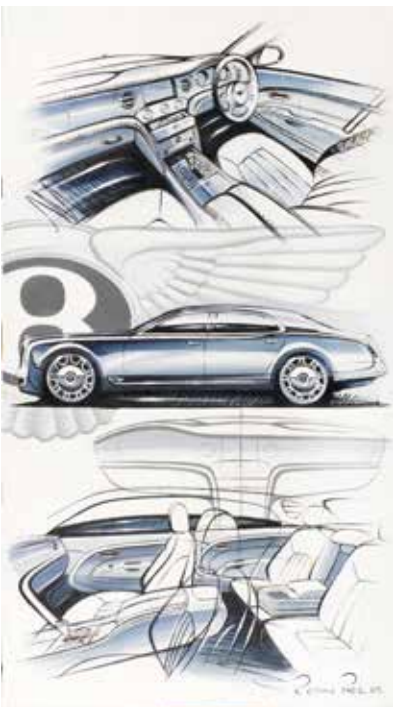
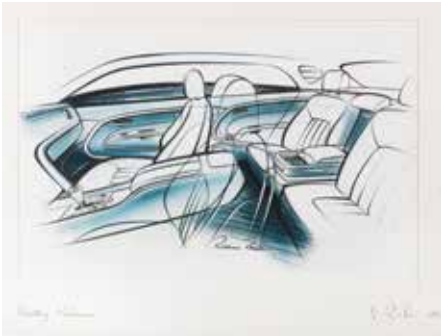
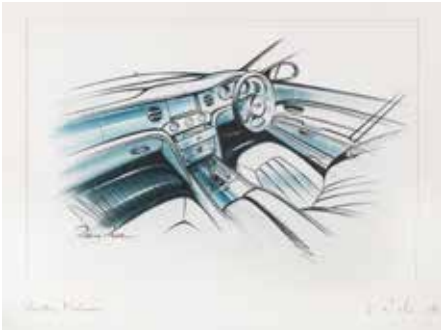

6

60
CRISPIN MARSHFIELD; "ART DECO POSTER" BENTLEY ARTWORK BY BENTLEY DESIGNER,

subtitled Bentley Ninety Glorious Years, signed and dated '09 on the mount, one off digital artwork, 140 x 110cm, matted, framed and glazed.

£1,000 - 1,200
 €1,100 - 1,400

Produced as an edition of one by Bentley Designer Crispin Marshfield for the Bentley Charity Auction on behalf of The Christie Hospital for Cancer Research, for the auction held at Bonhams New Bond Street on 1 December 2009, lot 25.

70

ROBIN PAGE, "BENTLEY MULSANNE" ARTWORK BY BENTLEY DESIGNER,

(then Head of Interior Design for Bentley Motors) signed acrylic on canvas, 100 x 55cm, together with three preliminary artworks in preparation for the painting, mixed media on paper, each framed and glazed 63 x 82cm overall.

(4)

£1,000 - 1,200
 €1,100 - 1,400

The larger artwork was originally produced for the Bentley Charity Auction on behalf of The Christie Hospital for Cancer Research held at Bonhams, New Bond Street on 1 December 2009, lot 5.

7



8



8



8



9



10

800

THREE ORIGINAL BENTLEY ARTWORKS BY BENTLEY DESIGNERS,

comprising Darren Day, "Bentley R Type Continental 1953 by H. J. Mulliner" tiled photomontage, 153 x 104cm, edition 1 of 1, signed on the mount, mounted, framed and glazed; Robin Page, "Ambience", (then Head of Interior Design for Bentley Motors) signed and dated 09, acrylic on canvas, 75 x 100cm; and Rajesh Kutty, "Complementing Facets", signed and dated 09, acrylic on canvas, 60 x 183cm. (3)

£1,000 - 1,200

€1,100 - 1,400

Originally produced as artworks for the Bentley Charity Auction on behalf of The Christie Hospital for Cancer Research, the auction held at Bonhams New Bond Street on 1 December 2009, lot 32, 7 and 37 (in catalogued order).

9

ANON, 'TARGA FLORIO 1929',

unsigned, with annotation to lower edge, acrylic on board, race scene featuring Albert Divo's Bugatti Type 35C on his way to victory, 44 x 67cm, framed.

£1,000 - 1,500

€1,100 - 1,700

10^{AR}

MICHAEL WRIGHT (BRITISH 1935-), 'MIKE HAWTHORN - 1958 TARGA FLORIO',

signed, watercolour and gouache on artists' paper, depicting Hawthorn at speed in the Ferrari 250 TR on his way to third place at the Circuito Piccolo delle Madonie, Sicily, 52 x 49cm, mounted, framed and glazed.

£1,000 - 1,500

€1,100 - 1,700

Provenance: Formerly from the Estate of racing driver and BRDC member, the Late John Young (1927-2017).

For details of the charges payable in addition to the final Hammer Price of each Lot please refer to paragraphs 7 & 8 of the Notice to Bidders at the back of the catalogue.



13



12



11

11^{AR}

SIMON TAYLOR (BRITISH 1969-), 'PORSCHE 917 - SPA 1970' ORIGINAL ARTWORK SIGNED BY THE DRIVER LEO KINNUNEN,

signed by the artist to lower left, mixed media on artists' paper, race scene depicting the Porsche 917 in Gulf Team colours driven by Leo Kinnunen at the 1,000Km endurance event, signed by the driver in black marker to lower right, 41 x 63cm, presentation mounted, framed and glazed, 72 x 92cm overall.

£1,200 - 1,600

€1,400 - 1,800

12^{AR}

ROY NOCKOLDS (BRITISH, 1911-1979), 'ROY SALVADORI - ASTON MARTIN DBR2 1957', PRESENTED BY DAVID BROWN TO ROY SALVADORI 1957,

signed and dated 1957, acrylic on board, race scene depicting Salvadori at the wheel of the 3.7 Litre DBR2/2 in its debut outing on his way to victory at the Silverstone International Race, leading Archie Scott-Brown in the Lister Jaguar and Tony Brooks in the Aston Martin DBR1, 50 x 60cm, framed and with presentation plaque to lower edge of frame engraved 'Presented to Roy Salvadori by Mr David Brown, December 16th 1957'.

£2,500 - 3,500

€2,800 - 4,000

Provenance: Roy Salvadori direct to John Young.

13^{AR}

TIM LAYZELL (BRITISH 1981-), 'ASTON MARTINS AT LE MANS', AN ORIGINAL FRONT COVER ARTWORK FOR VANTAGE MAGAZINE,

signed to lower right, acrylic on stretched canvas, race scene depicting four iconic Aston Martin Le Mans race cars from various eras at speed, comprising the 1959 Shelby/Salvadori winning DBR1/300, leading the 2008 Brabham/Garcia/Turner GT1 class winning DBR9, the 1962 Graham Hill DP212 Prototype, and the 1934 Aston Martin Ulster LM16 'BML 329', the canvas measuring 60.5 x 50.5cm and signed by the artist in black marker to the reverse.

£4,000 - 5,000

€4,500 - 5,700

This artwork was used to adorn the front cover of Vantage Magazine "Aston at Le Mans" Issue 6, Summer 2014, an edition of which is offered for sale with the Lot.

14

A SIGNED PRINT OF A SUPERMARINE SPITFIRE MK IX,

signed by Battle of Britain pilots including Douglas Bader, Bob Stanford-Tuck, Brian Kingcome, Christopher Foxley-Norris, Geoffrey Page and 27 other signatures, some faded, some illegible, 41 x 69cm, framed and glazed, (frame with taped repairs).

£1,000 - 1,400
€1,100 - 1,600



14



15

15

A BATTLE OF BRITAIN MUSEUM APPEAL SIGNED 'DAMBUSTERS' PRINT,

limited edition number 301/1000, depicting G for George as flown by Wing Commander Guy Gibson, after an illustration by Keith Broomfield, signed by the artist, with signature of Sir Arthur T Harris and 16 members of 617 Dambusters' Squadron, some ink faded, the print 37 x 55cm, framed and glazed, with laminated certificate applied to back of frame.

£1,000 - 1,400
€1,100 - 1,600



16



17

16†

A RARE KING GEORGE VI CORONATION ENAMEL CAR BADGE, 1937,

nickel-plated badge by Smiths Motor Accessories and marked to rear of stem, in red, white and blue enamel and featuring the Royal coronet, the centre bearing dual Royal cypher 'Crowned GviRER May 1937', one of a very limited number produced to commemorate the coronation of King George VI on 12th May 1937, the badge 7cm high, mounted on a turned wooden display base, offered together with an edition of The Coronation Book of King George VI and Queen Elizabeth, published by Odhams Press Ltd.

(2)

£1,000 - 1,500
€1,100 - 1,700



25



25



20



18



20

17†

A CASED DISPLAY SET OF 'BADGES OF THE WORLD'S GREAT MOTOR CARS', BY DANBURY MINT,

comprising 25 motor car emblems for the National Motor Museum at Beaulieu, including Alfa Romeo, Aston Martin Lagonda, Bentley, Bugatti, Ferrari, Maserati, Mercedes-Benz, Rolls-Royce and other marques, each finely detailed cloisonne enamel badge, common mounted in wooden display case, fitted with protective Perspex 'title' sheet and accompanying pamphlet, the case 39 x 30cm.

£1,000 - 1,200
€1,100 - 1,400

18

A 'GIRL IN THE MOON' MASCOT BY SYLVAIN KINSBURGER, FRENCH, CIRCA 1920,

signed to rear of base, bronze mascot depicting bust of a draped female with flowing hair within a crescent moon above a stylised cloud formation, 11.5cm high, mounted on a period radiator cap.

£1,000 - 1,400
€1,100 - 1,600

19

A BRONZE 'ANGEL OF VICTORY' CAR MASCOT, BY FRANZ BERGMAN, AUSTRIAN, 1920S,

signed 'Nam Greb' and with sculptor's 'B' initial in jar symbol mark to rear of base, finely detailed mascot in bronze with dark patina and traces of gilt decoration in places, 19cm high.

£1,200 - 1,500
€1,400 - 1,700

20

A 'HARE' AND A 'RABBIT' MASCOT, FRENCH,

comprising a stylised Hare by A Becquerel, circa 1930, signed, chrome-plated bronze, 19cm high, mounted on a wooden base, and a Rabbit mascot by Boffill, circa 1910, signed nickel-plated bronze, 12.5cm high, mounted on a marble base.

(2)

£1,000 - 1,500
€1,100 - 1,700

21

A HISPANO-SUIZA 'FLYING STORK' MASCOT BY F.BAZIN, FRENCH, 1920S,

signed to base and stamped 'HS 1357' under base, nickel-plated bronze, with riveted wing-tips, 19cm long, mounted on a light coloured marble display base.

£1,000 - 1,200
€1,100 - 1,400



19



22



23



21

22

A 'TETE DE SIOUX' MASCOT BY HENRI PAYEN, FRENCH, 1920S,

signed to base, nickel-plated bronze mascot in the form of a Native American Sioux chief, 13cm high, mounted on a wooden base.

£1,000 - 1,500
€1,100 - 1,700

23

A RARE 'GIGI' CAR MASCOT AFTER E. JULLIANI ORIGINALLY DESIGNED PERSONALLY FOR LUIGI VILLORESI, ITALIAN,

signed, spelter figure with bronzed patina depicting Villorresi in the Swiss Guard uniform of the Papal bodyguards, 16cm high, spear tip missing, weathered and pitted in places, mounted on a disc base for display.

£1,000 - 1,500
€1,100 - 1,700



24

to capture the Italian driving championship in the 1100 cc sports car class. The following year he and his brother purchased a Maserati which they drove individually in different races. Emilio was so successful that he was signed to drive an Alfa Romeo for Scuderia Ferrari in the 1937 season.

In 1938, Luigi Villorresi became part of the Maserati team, driving the 8CTF model designed to compete with the dominant German Silver Arrows. In 1939, Maserati introduced the Maserati 4CL which Villorresi drove to victory at the 1939 South African Grand Prix. Unfortunately, his brother Emilio died while testing a 158/159 Alfetta factory racer at Monza, two weeks later 'Gigi' drove a Maserati to victory at the 1939 Adriatic Grand Prix, dedicating the win to Emilio. His racing career was interrupted by the onset of World War II. At war's end, he returned to race for Maserati until 1949 when he signed again with Ferrari debuting in Formula 1 on 21 May 1950.

Villorresi retired from Grand Prix racing in 1957 after 31 Formula One championship starts, appearing on the podium 8 times while scoring a total of 49 championship points. Villorresi continued rally racing and won the Acropolis Rally in Greece in 1958 before moving to Modena to retire.

See: David Burgess-Wise: Automobile Archaeology, page 142.

Luigi Villorresi (16 May 1909 – 24 August 1997). Born in Milan, and nicknamed "Gigi" by family and friends, he was the older brother of race car driver Emilio Villorresi who co-piloted with him in several races at the beginning of their careers. From a prosperous family, Villorresi could afford to buy a car and began competing in local rallies at the age of twenty-two with a Lancia Lambda and a few years later acquired a Fiat Balilla with which he and his brother Emilio competed in the Mille Miglia. In 1935, he raced in the Coppa Ciano, finishing third and went on

For details of the charges payable in addition to the final Hammer Price of each Lot please refer to paragraphs 7 & 8 of the Notice to Bidders at the back of the catalogue.



27

24
A 'SNAKE GIRL' MASCOT BY M. PODIEBRAD, FRENCH, 1920S,
 signed to base, nickel-plated bronze mascot in the form of a crouched Egyptian female nude with serpent coiled around her body, 14cm high, mounted on a marble base.

£1,000 - 1,500
 €1,100 - 1,700

25
TWO 1920S EGYPTIAN THEMED MASCOTS, FRENCH,
 comprising 'Egyptian Dancer' by Alonzo, signed to base, 14.5cm high, and a 'Winged Egyptian' mascot after an original design by Bonnot, unsigned, 12cm high, each mounted on a marble base.
 (2)

£1,000 - 1,500
 €1,100 - 1,700

26†
A SCHNEIDER TROPHY SEAPLANE MASCOT BY DESMO, BRITISH, 1930S,
 chrome-plated, marked Desmo to either side of stem mount, with rotating propeller, 16cm wingspan, 13cm long overall, mounted on a turned wooden display base.

£1,000 - 1,500
 €1,100 - 1,700



28

27†
A 'FEMALE NUDE' MASCOT BY ALEXANDRE VIBERT, FRENCH, CIRCA 1905,
 signed to rear of base and with Jollet & Cie of Paris foundry stamp to rear, nickel-plated bronze mascot in the form of a standing female nude, 15cm high, mounted on a radiator cap above a turned wooden display base.

£1,000 - 1,500
 €1,100 - 1,700

28†
A 'CIGOGNE' (STORK) MASCOT BY SASPORTAS, FRENCH, CIRCA 1925,
 signed to edge of base, nickel-plated bronze mascot of a stork in flight, 21cm wingspan, mounted on correct period radiator cap with Bakelite ring (split in one place) and with turned wooden display base, offered together with two period monochrome photographs depicting the mascot fitted to a Hispano Suiza motor car.
 (4)

£1,000 - 1,500
 €1,100 - 1,700



29

29†
A 'COILED SERPENT' MASCOT BY DESMO, BRITISH, CIRCA 1930,
 unsigned, marked 'Desmo' to front of base and 'Copyright' to rear, nickel-plated bronze, in the form of a snake with head raised ready to strike, with remains of red paint to tongue, 18.5cm high, mounted on a turned wooden display base.

£1,000 - 1,500
 €1,100 - 1,700

30†
A RARE 'AGENT DE POLICE AU BAQUET' MASCOT BY ETIENNE MERCIER, FRENCH, CIRCA 1915,
 signed to rear, nickel-plated bronze mascot depicting a French Gendarme sitting in a bucket and waving his baton, smaller version of the mascot, 12cm high overall, mounted on a turned wooden display base.

£1,000 - 1,500
 €1,100 - 1,700



31†

A REPLICA 'WHISPER' MASCOT AFTER AN ORIGINAL DESIGN BY CHARLES SYKES, cast alloy, with 'Charles Sykes' facsimile signature to base, 16cm high, mounted on a marble base, offered together with a replica resin bronze effect statuette of 'Adam and Eve' also after Sykes, depicting the mythical couple in an embrace, with facsimile signature, 29.5cm high, on a marble base.

(2)

£1,000 - 1,200
€1,100 - 1,400

32†

A SCHNEIDER TROPHY GLOSTER VI SEAPLANE MASCOT, CIRCA 1930,

flush-riveted stainless steel, of the Napier engined racing seaplane with heat-treated coloured nacelle-covers and rotating propeller, 13cm wingspan, 14cm long, mounted on a turned wooden display base.

£1,000 - 1,500
€1,100 - 1,700

33†

A 'MILES MASTER' MASCOT,

chrome-plated, a representation of the World War II British fighter/trainer aircraft, decorated with RAF roundel decals to wings and fuselage, 17.5cm wingspan, 14cm long, above a stem and mounted on a turned wooden display base.

£1,000 - 1,500
€1,100 - 1,700

34†

A 'HAWKER HURRICANE' MASCOT,

nickel-plated, depicting the World War II fighter with rotating triple-bladed propeller and remains of RAF roundel decals, 18cm wingspan, 15cm long, raised on a stem and mounted on a black painted wooden base.

£1,000 - 1,500
€1,100 - 1,700

35

AN 'ALSATIAN DOG' MASCOT BY E. ILINSKY, FRENCH, 1920S,

signed with 'Fumiere et Cie' foundry stamp to base, nickel-plated bronze mascot of a seated Alsatian with chain, 16cm high, mounted on a black marble base.

£1,500 - 2,000
€1,700 - 2,300



33



34



35



36

36
**AN ART DECO 'GREYHOUND' MASCOT
 BY CASIMIR BRAU FOR AUTOMOBILES
 LORRAINE-DIETRICH, FRENCH, CIRCA
 1925,**

signed to left side of base, nickel-plated bronze,
 larger version of the mascot, 23cm long,
 mounted on a period radiator cap.

£1,500 - 2,000
 €1,700 - 2,300



37

37
**A 'GIRL RIDING TORTOISE' MASCOT BY
 ANTOINE BOFILL, FRENCH, CIRCA 1920,**

signed to rear of base, nickel-plated bronze
 with traces of original silver plating, 15cm high,
 mounted on a marble display base.

£1,500 - 2,500
 €1,700 - 2,800



38

38†
**AN 'ICARUS' MASCOT BY COLIN GEORGE
 FOR FARMAN CARS, FRENCH, CIRCA
 1920,**

signed to rear of drapery and with Contenot-
 Lelievre foundry stamp and further numbered
 '8295' to base, larger version of the mascot
 based on the 1911 design commissioned for
 Farman Aviation Works, 14.5cm high, 18cm
 wingspan, mounted on a turned wooden
 display base.

£1,500 - 2,000
 €1,700 - 2,300



32



26



40



39



41

39†

A 'PIERROT DANS LA LUNE' MASCOT BY ANTOINE BOFILL, FRENCH, CIRCA 1915,

signed to base, nickel-plated bronze mascot depicting a Pierrot playing a mandolin seated within a crescent moon, 14.5cm high, mounted on a radiator cap above a turned wooden display base.

£1,500 - 2,000

€1,700 - 2,300

40†

A SCHNEIDER TROPHY SEAPLANE SUPERMARINE MASCOT,

nickel-plated, inscribed 'Rolls-Royce' under one float, with rotating propeller, 15cm wingspan, 13cm long overall, mounted on a turned wooden display base.

£2,000 - 2,500

€2,300 - 2,800

41†

A 'COCOTTE' MASCOT FOR AUTOMOBILES VOISIN, CIRCA 1923,

unsigned, simple alloy construction with riveted wings depicting a bird in flight, this example is the rarer, larger version and not modified to fit a Calometer, 23cm high, mounted on a radiator cap.

£2,000 - 2,500

€2,300 - 2,800



42

42
A RARE 'LA RAFALE' MASCOT BY M. GUIRAUD-RIVIERE, FRENCH, CIRCA 1922,

signed to left side of base, large and impressive nickel-plated bronze mascot in the form of a crouching draped female with her cloak flowing behind in the wind, 20cm high and approximately 18cm long, mounted on an oval wooden display base with plaque engraved 'Sud-Radio Orly'.

£2,000 - 3,000
 €2,300 - 3,400

This mascot was joint silver medal winner at the 1922 L'Auto magazine Concours event.

43
A BRONZE 'JAGUAR' MASCOT BY FRANCOIS POMPON, FRENCH, 1920S,
 signed to side of base, solid cast bronze, 12cm long, mounted on a marble base.

£2,000 - 3,000
 €2,300 - 3,400



43

44†
AN 'EAGLE' MASCOT BY CASIMIR BRAU FOR MESSIER CARS, FRENCH, 1920S,
 signed to base, nickel-plated bronze mascot in the form of an eagle taking flight from a globe, as fitted to Messier 30cv cars, 21cm high, some verdigris in places, mounted on a nickelled radiator cap above turned wooden display base.

£2,000 - 3,000
 €2,300 - 3,400



44

For details of the charges payable in addition to the final Hammer Price of each Lot please refer to paragraphs 7 & 8 of the Notice to Bidders at the back of the catalogue.



46



47



45

45†
A 'FEMALE NUDE' MASCOT BY ANDRE CARON, FRENCH, CIRCA 1920,
 signed to base, nickel-plated bronze mascot depicting a standing female nude in graceful pose, 17.5cm high, mounted on a radiator cap above a turned wooden display base.

£2,000 - 3,000
 €2,300 - 3,400

46†
A RARE ART DECO 'HIBOU' (OWL) MASCOT BY ALFREDO BIAGINI FOR SASPORTAS, ITALIAN, 1920S,
 signed 'A Biagini' and 'Sasportas' to base, one of a limited edition produced and marked 'Epreuve 13/100' to front of base, 'hollow-cast nickel-plated bronze mascot, 15cm high, mounted on a period radiator cap above a turned wooden display base.

£2,000 - 3,000
 €2,300 - 3,400

47
A 'MR BIBENDUM' MASCOT FOR MICHELIN 'CABLE' TYRES BY GENERES, FRENCH, CIRCA 1920,
 nickel plated bronze mascot, marked 'Made in France' and 'Generes' to underside of base, depicting Mr Bibendum in Pathfinder 'searching the horizon' kneeling pose on a tyre, 11.5cm high, mounted on a black painted wooden base.

£2,400 - 3,200
 €2,700 - 3,600

48†
A LARGE SCHNEIDER TROPHY SEAPLANE MASCOT, CIRCA 1930,
 nickel-plated, with rotating propeller, 14.5cm wingspan, 18cm long overall, offered together with an edition of Derek N James: Schneider Trophy Aircraft 1913-1931.
 (2)

£3,000 - 3,500
 €3,400 - 4,000

49†

A 'GRENOUILLE' (LEAPING FROG) MASCOT BY A RENEVEY, FRENCH, CIRCA 1915, RETAILED BY DUNHILL,

signed to base, nickel-plated bronze mascot, 16.5cm long, mounted on a turned wooden display base, together with a photocopied page of the Dunhill catalogue featuring the mascot. (2)

£3,000 - 4,000
€3,400 - 4,500

50†

A 'BOHUN ROYAL SWAN' MASCOT, 1920S, SPECIALLY COMMISSIONED BY THE LUTTRELL FAMILY, BARONY OF DUNSTER,

unsigned mascot in nickel-plated bronze, in the form of a chained swan with Royal crown as featured on the Luttrell Family heraldic crest at Dunster Castle, Somerset, believed to have been commissioned by the Luttrell Family and later fitted to the Eight Litre Bentley of Colonel Sir Geoffrey Walter Fownes Luttrell (1919-2007), the mascot 11cm high and mounted on the solid nickel radiator cap as originally mounted on Sir Walter Luttrell's Bentley.

£3,000 - 4,000
€3,400 - 4,500



48



48



49



50

For details of the charges payable in addition to the final Hammer Price of each Lot please refer to paragraphs 7 & 8 of the Notice to Bidders at the back of the catalogue.

51†

**A RARE 'FAUNE COURANTE' MASCOT BY
JOE DESCOMPS, FRENCH, CIRCA 1925,**

signed to base, nickel-plated bronze mascot by
the Etling foundry of Paris, depicting a running
faun, larger version of the mascot, 17.5cm high,
mounted on a radiator cap above a turned
wooden display base.

£3,000 - 4,000

€3,400 - 4,500



For details of the charges payable in addition to the final Hammer Price of each Lot please refer to paragraphs 7 & 8 of the Notice to Bidders at the back of the catalogue.

52†

**A FINE ART DECO 'LEAPING HORSE'
MASCOT BY CASIMIR BRAU, FRENCH,
CIRCA 1925,**

signed to base, nickel-plated bronze, larger
version of the mascot, 22cm long, mounted on
a turned wooden display base.

£3,000 - 4,000

€3,400 - 4,500



52



53†

**A RARE AND EARLY 'L'ETOILE FILANTE'
(SHOOTING STAR) MASCOT BY JEAN
GARNIER, FRENCH, CIRCA 1905,**

signed 'J.Garnier' to front of base, nickel-plated
bronze mascot in the form of a female nude
riding the tail of a shooting star, approximately
22.5cm long, mounted on a turned wooden
display base.

£3,000 - 4,000

€3,400 - 4,500

53

For details of the charges
payable in addition to the final
Hammer Price of each Lot
please refer to paragraphs 7 &
8 of the Notice to Bidders at
the back of the catalogue.



54

54

A SCARCE PAINTED MICKEY MOUSE MASCOT, BY DESMO, BRITISH, CIRCA 1930,

chrome-plated bronze mascot depicting Mickey with hands on hips, painted in cream, red and black, (some loss to paint), with long tail, on correct metal disc base stamped Desmo further stamped 'By Permission Walt Disney - Mickey Mouse Ltd', 13.3cm high, mounted on a black painted wooden display base.

£3,000 - 3,500

€3,400 - 4,000

55†

A FINE AND RARE 'RODEO' MASCOT BY A E LEJEUNE AFTER THE ORIGINAL DESIGN BY CHARLES PAILLET, BRITISH, CIRCA 1920,

signed 'Paillet' to base and stamped 'Copyright AEL' to rear of base, nickel-plated bronze, finely detailed mascot depicting a 'Cowboy' leaping from his steed onto a bull, from the original design by the French sculptor Charles Paillet and sold to London based Augustine and Emille Lejeune in 1917 and produced under copyright, measuring 13cm long, mounted on a turned wooden display base, and offered together with photostat copy of the 1919 'Mascottes Artistique pour Automobiles "Rodeo"' catalogue featuring the mascot.

(2)

£4,000 - 5,000

€4,500 - 5,700



55

56†

A RARE 'FEMME AVEC LUNE' MASCOT BY JACQUES DORVAL, FRENCH, CIRCA 1910,

signed and with E.Julien of Paris foundry stamp to rear of base, nickel-plated bronze mascot depicting a graceful female nude holding a crescent moon, 19cm high, mounted on a radiator cap above a turned wooden display base.

£4,000 - 5,000

€4,500 - 5,700



56

57†

A RARE 'LA CONQUETE DU SAHARA' MASCOT BY MARCEL BONNOT, FRENCH, CIRCA 1923,

stamped 'M Bonnot' to rear of base and inscribed with title to front edge, nickel-plated bronze mascot depicting a graceful female nude carrying a Citroen-Kegresse 'Autochenilles' Half-Track vehicle, 14.5cm high, mounted on a period radiator cap above a turned wooden display base, offered together with a 1923 edition of the title Georges-Marie Haardt & Louis Audouin-Dubreuil: Le Raid Citroen - La Premiere Traversee du Sahara an Automobile; a French text account of the journey. (2)

£4,000 - 5,000

€4,500 - 5,700

This mascot was produced to celebrate the first motorised crossing of the Sahara desert from Touggourt to Timbuktu in December 1922 to January 1923, in a Citroen-Kegresse Type B2 10Hp Half-Track vehicle driven by the enterprising adventurers Haardt and Audouin-Dubreuil.



57



58

58†

A FINE "HOTCHKISS" COCKEREL MASCOT, BY AUGUST CAIN, FRENCH, CIRCA 1924,

signed 'A.Cain', also bearing Susse Freres, Paris signature, foundry stamp and further stamped '37' to rear of base, finely detailed mascot in 'cire-perdue' cast bronze, depicting a resplendent crowing cockerel, complete with Hotchkiss-Paris emblem to base, the hollow base with twin stud for correct position mounting, 16cm high, mounted on a turned wooden display base and offered together with original bronze radiator cap.

(2)

£5,000 - 6,000

€5,700 - 6,800

Provenance: This mascot is formerly from the Pierre Deschamps collection and an image of this actual example is illustrated in the book by Michel Legrand: Mascottes Continuïte Volume II - Collection de Pierre Deschamps; (see page 73, Plate 139). A photocopy of the relevant page is offered for sale with the Lot.

These mascots were only fitted to the car of the President of France and Chamber of Deputies government cars, and was the only mascot produced by the Parisian sculptor August Cain.

59†

A FINE AND RARE 'LION' MASCOT BY G POITVIN, RETAILED BY HERMES, FRENCH, CIRCA 1920,

signed to rear of hollow-cast base with Contenot & Lelievre foundry cartouche to underside and with further '(C&L)' stamps and foundry casting numbers to rear of base, nickel-plated bronze mascot in the form of a proud lion with stylised mane, 15cm long, mounted on a turned wooden display base.

£5,000 - 6,000

€5,700 - 6,800



59



60



60

60†
A RARE BANKING 'SCHNEIDER TROPHY SEAPLANE' MASCOT, BRITISH, CIRCA 1930,

nickel-plated bronze, depicting the 1929 Schneider Trophy winning Supermarine S6b racing seaplane, with rotating propeller and faintly inscribed roundel markings to wings, mounted to swivelled stem allowing the aircraft to bank and tilt as the car is driven, 17cm wingspan, 18cm long overall, mounted on a turned wooden display base, offered together with an original 1929 Official Souvenir Programme for the event.

(2)

£5,000 - 6,000

€5,700 - 6,800

61†
A RARE 'MOVIE CAMERA' MASCOT, BRITISH, REGISTERED DESIGN 1930,

nickel-plated bronze mascot in the form of a reel-to-reel film camera, stamped with Registered Design number 765659 to side, 15cm long, 12cm high, mounted on a radiator cap above a turned wooden display base.

£5,000 - 6,000

€5,700 - 6,800

According to information supplied by the vendor, it is believed that this mascot was produced for the Managing Director of the British Gaumont Cinema Cameras and Picture Houses Company, UK.



61



62



62

62

A 'DRAGONFLY' AND A 'GAZELLE' OPALESCENT GLASS MASCOTS BY SABINO, PARIS, 1930S,

each inscribed 'Sabino Paris' under base, the Dragonfly with moulded mark 'Sabino Paris' under tail, 15cm high, the Gazelle similarly moulded under the abdomen, 15.5cm long.

(2)

£1,000 - 1,200

€1,100 - 1,400

63

A PAIR OF 'HIRONDELLE' GLASS BOOKENDS BY CRISTAL LALIQUE, POST-WAR,

each stencil etched 'Lalique France' under the base, in the form of a perched swallow in clear glass, modelled after the original mascot designed by Rene Lalique and introduced 10th February 1928, each 16cm high.

(2)

£1,000 - 1,500

€1,100 - 1,700



63



63



64

64
A 'LEVRIER' GLASS MASCOT BY RENE LALIQUE, FRENCH, INTRODUCED 14TH MARCH, 1928,

intaglio moulded 'R.Lalique' with double-tailed 'Q' and 'France' to lower edge, with deep impressed depiction of a running greyhound, 19.7cm wide, one small chip to rear upper edge of base and some minor chips and scratches elsewhere mainly visible from the reverse.

£1,000 - 1,500
 €1,100 - 1,700

65†
TWO ART DECO 'NU LONGS CHEVEUX' MASCOTS IN OPALESCENT GLASS BY LUCILE SEVIN FOR ETILING OF PARIS, CIRCA 1932,

each moulded 'Etling France 86' to rear of base, in the form of a graceful female nude with long cascading hair, 22.5cm high, one with chip to rear of left hand, the other with chip to right shoulder, offered together with a reproduction 'Draped Nude' glass mascot by Cristal de Sevres of France, 1970s, etched 'Sevres France' under base, and engraved 'Cristal de Sevres' and numbered '729/2000' to edge of base, a limited edition after the original design by Lucile Sevin for Etling, in satin glass depicting graceful draped female standing holding her dress out, with her head held to one side, 20.5cm high.

(3)

£1,000 - 1,500
 €1,100 - 1,700



65

65

65



66

66

AN ART DECO 'DRAPED NUDE' GLASS MASCOT BY LUCILE SEVIN FOR ETLING, FRENCH, INTRODUCED 1932,

in satin glass, moulded 'Etling France 50' to side of stepped base, depicting graceful draped female standing holding her dress out, with her head held to one side, fixed within black painted wooden base, 22cm high overall.

£1,500 - 2,500

€1,700 - 2,800

67†

A 'TETE D'AIGLE' GLASS MASCOT BY RENE LALIQUE, FRENCH, INTRODUCED 14TH MARCH 1928,

moulded 'R Lalique' and 'France' to either side of neck, in the form of an eagle's head in clear and frosted glass, 14cm long.

£2,000 - 3,000

€2,300 - 3,400



67



68†

A 'CHRYSIS' GLASS MASCOT, BY RENE LALIQUE, FRENCH, INTRODUCED 21ST MARCH, 1931,

stencil etched 'R Lalique' under base, in clear glass with satin finish, in the form of a backwards leaning female nude, approximately 16cm long.

£2,000 - 3,000

€2,300 - 3,400

69†

A 'LONGCHAMP' MASCOT IN GLASS WITH YELLOW TINT BY PERSONS MAJESTIC COMPANY OF WORCESTER, MASSACHUSETTS, 1930S,

with moulded manufacturer's markings around the base of the neck, in the form of a horse's head in glass with pale yellow tint, 13cm high, modelled after the original 'Longchamp' design by Rene Lalique.

£2,000 - 2,500

€2,300 - 2,800

68



69



70

70†

A 'FAUCON' GLASS MASCOT BY RENE LALIQUE, FRENCH, INTRODUCED 5TH AUGUST 1925, moulded 'R Lalique' and wheel-cut 'France' around the base, with engraved catalogue number 'N.1124' under the base, in the form of a Falcon in clear glass, 16cm high.

£2,000 - 3,000
€2,300 - 3,400



71

71†

A 'FAUCON' GLASS MASCOT BY RENE LALIQUE, FRENCH, INTRODUCED 5TH AUGUST 1925, moulded 'R Lalique' and wheel-cut 'France' around the base, with engraved catalogue number 'N.1124' under the base, in the form of a Falcon in clear glass, 16cm high, fitted within a nickel-plated illumination radiator mount marked 'Breves Galleries, Knightsbridge' with bayonet-type socket, the whole mounted on a turned wooden display base.

£3,000 - 4,000
€3,400 - 4,500



72†

**A FINE 'VICTOIRE' GLASS MASCOT BY RENE LALIQUE, FRENCH,
INTRODUCED 18TH APRIL 1928,**

moulded 'R Lalique' and 'France' to side and rear of neck, in clear and satin finish glass, some internal bubbles to hair and minor surface chips to tip of hair, 26cm long.

£20,000 - 25,000

€23,000 - 28,000



74



73



76



75



75



77



75



78



79

73† AN ILLUMINATING RADIATOR MOUNT TO SUIT LALIQUE GLASS MASCOTS,

polished nickel-plate, fitted with two bulbs and other connection fittings and wired with modern 5mm jack plug, with threaded ring surround and inside single-split ring collar with inside diameter measuring approximately 70mm, to suit selected larger Laliq pre-War glass mascots including Falcon.

£1,000 - 1,500
€1,100 - 1,700

74† AN ILLUMINATING RADIATOR MOUNT TO SUIT LALIQUE GLASS MASCOTS,

nickel-plated, marked 'Breves Galleries Knightsbridge SW3 Pat No. 309301', fitted with bulb and other connection fittings and complete with bayonet type socket and mounting stud, with quartered orange/green coloured filter plastic disc, with threaded ring surround with inside diameter measuring 68mm, to suit selected larger Laliq pre-War glass mascots including Falcon.

£1,000 - 1,500
€1,100 - 1,700

75 A SCARCE ENOTS 1½ TON HYDRAULIC JACK, MODEL 70B, LATE 1920S, nickelled case and moulded stand base, single-hydraulic ram with manual screw extension, would suit Vintage Bentley 3 litre, 4½ litre, Supercharged 4½ litre and 6 litre cars, with two part handle, contained in leather draw-string bag, together with a Smiths Wootton lantern. (3)

£1,000 - 1,200
€1,100 - 1,400

76 A RARE CASED ROBERT BOSCH ZR6 MAGNETO REPAIR KIT, opening to purple felt lined interior housing magneto parts and accessories (some missing), the case 21 x 18.5 x 6cm, with paper covering (worn, lid loose) stamped in German text on lid.

£1,000 - 1,200
€1,100 - 1,400

77 A SCINTILLA "VERTEX" 8-CYLINDER MAGNETO AND A SMITHS CAR CLOCK TO SUIT PRE-WAR BUGATTI, the G2 NV8-581689 magneto of Swiss manufacture, with plaque numbered 480-900-10°, with Bakelite cap, used condition, believed to suit various models including Type 59 Bugatti, the dashboard clock by Smiths, Swiss movement, with black dial and Roman numerals and Time of Trip subsidiary dial, nickelled surround with bevelled lens, the rear of case numbered 131349. (2)

£1,000 - 1,200
€1,100 - 1,400

78 ASSORTED FERRARI 250GT SPARES, comprising five knock-off wheel spinners, a Schedoni leather base to display a spinner, a horn push, a gear lever knob, a door latch tightening spring, the remains of a Veglia instrument with some internals and a small crank handle.

£1,000 - 1,200
€1,100 - 1,400



80

79

COLONEL RONNIE HOARE'S PERSONAL WOOD-RIMMED STEERING WHEEL BY NARDI OF TORINO ITALY,

the three-spoke "anni '60" wheel from the Nardi AutoAccessories Collection to suit various models including Ferrari 250 GTO, with wood rim, 38cm outside diameter, with manufacturer's markings to rear of spoke and with 'Nardi Torino' centre boss engraved to edge 'col. R. J. Hoare', in seemingly unused condition and complete with elasticated blue felt cover and original box bearing label marked 'R. J. Hoare', offered together with a Nardi related book by Franco Varisco and other personal motoring items comprising a Royal Horse Artillery enamel car badge by J R Gaunt of London (some loss to enamel), an enamelled Spa Royal Automobile Club metal plaque, an Automobile Club de L'Ouest 1964 Le Mans driver entrant's bronze medal, four small enamel Ferrari 'lapel' badges, and a 1987 'Anni 250 GTO' 25-Year commemorative blue canvas documents pouch, containing two chromed plaques and a Cavallino International folder with ephemera relating to the event sponsored by Moët & Chandon and held on France 7th-14th June. (Qty)

£1,000 - 1,500

€1,100 - 1,700

Former British Army Officer, motoring enthusiast, car dealer, and pre-War Brooklands driver the Late Ronnie Hoare CBE, 'The Colonel' was perhaps most noted for founding the Maranello Concessionaires official UK importer and dealer of Ferrari road cars and Racing Team after an agreement with Enzo Ferrari in 1960, and provided cars for various race events including Le Mans.

For details of the charges payable in addition to the final Hammer Price of each Lot please refer to paragraphs 7 & 8 of the Notice to Bidders at the back of the catalogue.



81

80

A THREE LITRE SUNBEAM STEERING WHEEL, IN FRAMED DISPLAY DATED 1925-26,

believed to suit twin-cam car, the metal four spoked wheel with whipped cord rim and leather joint covers, 46cm diameter, mounted in a glazed case, weathered, together with two photographs from the Geoffrey Goddard Collection depicting Dario Resta winner at the 1924 South Harting hill climb with f.t.d. of 25.8 seconds and H.O.D Segrave winner of the 1923 GP de l'A.C.F., each in Three Litre Sunbeam racing cars depicting a similar design of Sunbeam steering wheel.

(3)

£1,200 - 1,600

€1,400 - 1,800

81◇

A SIX PIECE SET OF FERRARI 550 MARANELLO LUGGAGE BY SCHEDONI, ITALY,

to fit 1998 car, all soft black leather embossed 550 Maranello, with red stitching, locks, keys and yellow cloth storage bags, comprising two suitcases, two suit carriers, a Gladstone style vanity case and a shoe bag, used but in good condition.

(Qty)

£3,000 - 4,000

€3,400 - 4,500



82

82◇

TWO BESPOKE LEATHER CASES FOR BENTLEY CONTINENTAL GT,

by Trunks of Haslemere, in dark blue leather with chromed locks and catches, trunk-style hard-sided cases with Bentley Winged 'B' emblems to front of lids, dark blue linings, the larger measuring 71 x 28 x 31cm, the other 63 x 30 x 29cm, with keys, each with beige cloth draw-string protective bag.

(4)

£1,000 - 1,200

€1,100 - 1,400



84



85



86



87



83

83†
TWO EDWARDIAN LEATHER-CASED TRAVELLING DRINKS SETS,
 the first a cased set of drinks bottles with sterling silver caps by William Amaziah Ellwick of London, 1909, honey leather cylindrical case with leather strap and buckle, fitted with four glass flasks with glass stoppers and sterling silver caps hallmarked London 1909, some dents to caps in places, the case 16cm high overall, the second a circa 1906 set in dark brown leather case, fitted with two glass drinks bottles with sterling silver caps, hallmarked London with engraved monogram initials 'P.H.' to caps and embossed to lid, the case 20cm high overall.
 (2)

£1,000 - 1,500
 €1,100 - 1,700

84◇
A SET OF FOUR PIECES OF FERRARI 328 LUGGAGE BY SCHEDONI, ITALIAN, LATE 1980S,
 in tan leather, new/old stock, unused, comprising two large cases, a vanity case and a shoe case (with four cloth shoe covers), each piece stamped with Ferrari Cavallino, with keys, leather Ferrari luggage tag and cloth over-bag, after long period of storage the leather would benefit from a feed before use.
 (4)

£1,800 - 2,400
 €2,000 - 2,700

85†
A TRAVELLING COCKTAIL SET FOR FOUR PERSONS,
 plated metal, with cap with strainer containing set of four stacking gilt-lined drinking tots, and the main body with lemon squeezer, and containing set of three glass drinks bottles, measuring 27cm high overall.

£1,000 - 1,500
 €1,100 - 1,700

86†
A TRAVELLING COCKTAIL SET,
 plated metal, with cap with strainer and lid containing three gilt-lined nested drinking cups and funnel, the main body with lemon squeezer and containing set of three glass drinks bottles with small drinking tots fitted over the caps, measuring 22cm high overall.

£1,000 - 1,500
 €1,100 - 1,700

87†
A LEATHER CASED COCKTAIL SET FOR FOUR PERSONS, CIRCA 1909,
 brown leather suitcase with leather handle, nickelled locks and catches, the lid opening to light-brown suede interior fitted with central nickel-plated cocktail shaker containing glass bitters bottle and four gilt-lined stacking drinking tots, four glass drinks bottles with nickel-plated caps, a set of four gilt-lined nickel-plated tumblers, and mixing spoon housed in the lid, some staining and old damage to interior, the lid with embossed initials 'S.A.M.', the case measuring 41cm wide.

£1,000 - 1,500
 €1,100 - 1,700



88



89



90



91



91

88†
A SMALL LEATHER CASED TRAVELLING DRINKS SET FOR FOUR PERSONS, POST-WAR,

of West German manufacture, brown leather case with nickelled catch, the lid opening to interior fitted with a pair of plated drinks flasks, each incorporating two drinking tots cleverly concealed within the main body, the case 17cm high, for dashboard compartment fitting, and with gilt-embossed 'W.B.' initials to lid.

£1,000 - 1,500
 €1,100 - 1,700

89†
A LEATHER-CASED TRAVELLER'S COCKTAIL SET FOR SIX PERSONS BY JAMES DIXON & SONS, CIRCA 1909,

black pigskin cylindrical case, opening to interior fitted with central electro-plated cocktail shaker containing a set of six stacked tumblers and a bitters bottle, surrounded by three curved hip-flasks marked 'Gin', 'French' and 'Italian', all with maker's stamps to underside, the case 19cm high overall.

£1,500 - 2,000
 €1,700 - 2,300

90†
A LEATHER-CASED TRAVELLING COCKTAIL SET FOR SIX PERSONS BY JAMES DIXON & SONS, BRITISH, CIRCA 1909,

tan pig-skin cylindrical case with handle to lid, opening to interior fitted with central electro-plated cocktail shaker containing a set of six stacking drinking tots, and a glass bitters bottle, and surrounded by set of three EPBM curved 7oz hip-flasks, the case measuring 20cm high overall.

£1,500 - 2,000
 €1,700 - 2,300

91†
A FINE LEATHER-CASED TRAVELLER'S COCKTAIL BAR SET FOR EIGHT PERSONS BY P.H.VOGEL & CO., BRITISH,

believed immediate post-War, brown pigskin case with leather carrying strap and nickelled locks and catches, the lid incorporating two Formica panels and folding down to form a small drinks bar, and revealing interior fitted with central EPNS cocktail shaker containing a set of six stacked gilt-lined EPNS drinking tumblers and bitters bottle, and four EPNS drinks flasks with hinged caps, with measuring cup and funnel held in clips in the lid, each piece stamped with maker's marks, the case measuring 32cm wide with impressed initials 'PV' to the lid.

£3,000 - 4,000
 €3,400 - 4,500



92



94



93



95

92†
**A CHRISTOPHER DRESSER DESIGN
 CASED TEA-SET FOR TWO PERSONS,
 CIRCA 1903,**
 black leather-cloth case with replaced leather handle, with double doors opening to dark blue velvet lined interior, the upper level fitted with wicker-handled gilded kettle containing tea caddy, folding stand, a similarly gilded wicker-handled tea-pot containing milk jug and sugar bowl, and small milk flask, the lower level fitted with paraffin burner, and two fluted gilt-handled bone china Bisto tea-cups on velvet pads with saucers, with sugar tongs and teaspoons housed in the doors, the case measuring 29 x 15 x 19cm overall.

£1,000 - 1,500
 €1,100 - 1,700

93†
**A WICKER-CASED 'CORACLE' TEA/
 PICNIC SET FOR TWO PERSONS BY G W
 SCOTT & SONS, CIRCA 1905,**
 the wicker case with brass handle to lid, with lock and catch, the lid and fall-front opening to interior fitted with wicker-handled copper kettle with burner, wicker-covered glass bottle, a food tin, two ceramic tea-cups held in metal frame, and two rectangular enamel serving plates, with cutlery and Vesta case housed behind leather straps in the lid, the case measuring 32 x 22 x 25cm overall.

£1,000 - 1,500
 €1,100 - 1,700

94†
**A CHRISTOPHER DRESSER DESIGN
 CASED TEA-SET FOR TWO PERSONS,
 EARLY 20TH CENTURY,**
 black leather-cloth case with leather handle, with lid and double doors opening to grey suede lined interior, the upper level fitted with wicker-handled nickel-plated kettle containing tea caddy, with paraffin burner and folding stand, wicker-handled tea-pot containing milk jug and sugar bowl, and small milk flask, the lower level fitted with two Royal Worcester pink-glaze bone china tea-cups on velvet pads with saucers, with sugar tongs and teaspoons housed in the doors, the lid with embossed initials 'M.C.', the case measuring 29 x 15 x 18cm overall.

£1,500 - 2,000
 €1,700 - 2,300

95†

A LEATHER-CASED TEA-SET FOR THREE PERSONS BY FINNIGANS OF NEW BOND ST, CIRCA 1905,

honey leather case with leather handle, nickelled lock and catch, with fall from opening to reveal dark green cloth-lined interior fitted with wicker-handled kettle with burner, a tea-caddy tin housing three tea-spoons, a set of three Mintons gilt-handled bone china tea-cups and three saucers, and a small leather-covered glass milk bottle, the inside of the lid gilt-embossed with manufacturer's branding, the case measuring 31 x 15 x 18cm.

£2,000 - 3,000
€2,300 - 3,400

96† ◊

A CASED "CORACLE" PICNIC SET FOR SIX PERSONS, BY G W SCOTT & SONS, CIRCA 1925,

black leather-cloth case, with nickelled handles, locks and catches, the lid and fall-front opening to interior with wicker framework fitted with wicker-handled kettle with burner, two Thermos vacuum flasks, two large wicker-covered glass bottles, two enamel-based food containers, a smaller food tin, six ceramic tea-cups with saucers, six gilt-edged circular enamel plates, ceramic butter and preserves jars, and six metal tumblers stacked in two wicker cases, with cutlery housed behind leather straps in the lid, the case measuring 68cm wide.

£3,000 - 4,000
€3,400 - 4,500

97† ◊

A FINE CASED PICNIC SET FOR FOUR PERSONS BY G W SCOTT & SONS, CIRCA 1909,

the black textured leather-cloth case with brown leather edging, brass handles, locks and catches, the lid opening to dark green textured leather-cloth lined interior, with compartments fitted with various picnic accessories including wicker-handled copper kettle with burner, spirit flask, two glass bottles, a ceramic-based food box, three other food tins, a set of four enamelled gilt-edged tea-cups contained in metal frame, four stacked enamelled drinking cups, four enamelled circular plates, a ceramic butter/preserves jar with leather strap, condiments jars, and a nickel-plated collapsible drinks cup with integral folding handle, with cutlery housed behind sprung clips in the lid, the case measuring 68 x 23 x 27cm overall, with two keys.

£4,000 - 5,000
€4,500 - 5,700



96



97



98

98† ◊

A FINE CASED PICNIC SET FOR FOUR PERSONS BY G W SCOTT & SONS, CIRCA 1909,

black leather-cloth case, with brass handles, lock and catches, with lid and fall-front opening to interior with wicker framework fitted with central wicker-handled kettle in sauce-pan with burner, spirit flask, two large wicker-covered glass drinks bottles, a smaller glass bottle, a ceramic-based food box, two food tins, a set of four gilt-edged Bisto bone china tea-cups with accompanying saucers, a set of four rectangular enamelled serving plates, ceramic butter and preserves jars with leather straps, four glass beakers in wicker cases, and condiments jars, with cutlery housed behind leather straps in the lid, the case measuring 61 x 22 x 31cm, complete with key.

£5,000 - 6,000

€5,700 - 6,800

99† ◊◊

A FINE AND IMPRESSIVE CASED PICNIC SET FOR SIX PERSONS BY MOYNAT OF PARIS, CIRCA 1907,

black leather-cloth case with brown leather edging, with leather handles, brass lock and sprung catches, opening to reveal interior with wooden compartmentalised interior fitted with various picnic accessories including wicker handled kettle and tea-pot set in saucepans, with ornate double-burner with pieced horseshoe decoration, two deep sandwich boxes, two wicker covered glass drinks bottles on lift-out wooden panels revealing smaller food tin, a smaller glass bottle and condiments jars underneath, six rectangular enamel serving plates, another food tin, ceramic butter and preserves jars with leather straps, a set of six ceramic tea-cups on two levels and six drinking glasses, with the cutlery, set of six saucers and Vesta case housed behind leather straps in the lid, the case measuring 80 x 39 x 26cm overall.

£5,000 - 6,000

€5,700 - 6,800



99

100† ◊

A RUNNING-BOARD MOUNTING PICNIC SET FOR SIX PERSONS BY G W SCOTT & SONS, BRITISH, CIRCA 1909,

black leather-cloth case with brass handles, lock and catches, the lid with ridged tread and nickelled surround, opening to reveal interior with wicker framework fitted with wicker-handled copper kettle with burner, spirit flask, two large wicker-covered glass bottles, two Coracle brand ceramic based food boxes, a smaller glass bottle, six ceramic tea-cups, a ceramic butter jar with leather strap, and six drinking glasses in wicker cases, with cutlery and saucers housed behind leather straps in the lid, the case measuring 74 x 31 x 20cm overall.

£5,000 - 6,000

€5,700 - 6,800

101† ◊◊

A RARE AND IMPRESSIVE CASED PICNIC SET FOR TEN PERSONS BY G W SCOTT & SONS, BRITISH, CIRCA 1909,

produced for the American market for retail by the I. Magnin & Co Inc. department store, the black leather-cloth case, with nickelled handles, locks and catches, the lid opening to reveal interior with fine woven wicker framework fitted with wicker-handled twin kettle and teapot, both fitted within two wicker-handled saucepans with folding wicker handles, a double burner with pierced decorative horseshoe design, two "Coracle" brand ceramic-based food containers, a set of ten Paragon bone china tea-cups with eight saucers, ten glass tumblers stacked in wicker frames, ceramic butter and preserves jars and a small food tin, with set of circular gilt-edged enamel plates, final two saucers, and cutlery housed behind leather straps in the lid, bearing retailer's small leather patch, the case measuring 78 x 38 x 20cm overall, complete with key.

(2)

£8,000 - 10,000

€9,100 - 11,000



100



101



102

102† ◊

**A FINE AND IMPRESSIVE CASED PICNIC SET FOR SIX PERSONS
BY G W SCOTT & SONS, CIRCA 1909,**

large black leather-cloth case with nickelled handles, lock and catches, with lid and fall-front opening to interior with wicker framework, fitted with central copper kettle with woven wicker handle, with ornate stand and burner, two Thermos flasks, two wicker-covered drinks bottles, two Coracle ceramic based food containers, another food tin, a set of six Bisto gilt-edged china cups and accompanying saucers, Coracle ceramic butter and preserves jars, six stacking glass tumblers in wicker frames, condiments jars, and six enamel rectangular plates, with cutlery housed behind leather straps in the lid, complete with key, the case measuring 76 x 27 x 33cm.

£10,000 - 15,000

€11,000 - 17,000

For details of the charges payable in addition to the final Hammer Price of each Lot please refer to paragraphs 7 & 8 of the Notice to Bidders at the back of the catalogue.



103† ∞

A FINE AND IMPRESSIVE WOODEN CASED FOUR-PERSON PICNIC SET AND GAMES TABLE COMBINATION BY DREW & SONS OF PICCADILLY, CIRCA 1909,

the dark wooden case with polished brass handles, edging, lock, catch and hinges, the lid opening to reveal compartmentalised interior with red leather lining, fitted with full complement of picnic accessories comprising wicker-handled kettle rested in saucepan with folding handles, and burner with pierced decorative design, large vacuum flask by Jsola, a smaller Autotherm flask and wicker-covered glass bottle both contained in red leather pouch, three smaller glass bottles, two condiments jars, a set of four gilt-handled bone china tea-cups stacked in metal frame, an enamel-based food container, a smaller food tin, a set of four nested gilt-lined tumblers, a wicker-covered condiments jar, and two small condiments tins, with two hinged fold-out side-leaves, one fitted with set of four rectangular enamel plates and tea-spoons, the other with two sets of Duplex Pashas playing cards in red leather cases, a notebook and pencil, all housed behind tan leather straps, and with set of four bone china saucers and cutlery housed in the lid bearing small Ivorine maker's plaque, the case measuring 70 x 34 x 23cm, the lid with two hinged fold-out leaves opening out to form a card table with green baize playing surface and the underside of the case incorporating two sets of fold-down trestle legs forming the games table, and standing 78cm high overall, offered together with two keys.

(3)

£20,000 - 25,000

£23,000 - 28,000



For details of the charges payable in addition to the final Hammer Price of each Lot please refer to paragraphs 7 & 8 of the Notice to Bidders at the back of the catalogue.



104



106



107



105



105 (interior detail)



108

104
ASSORTED LOUIS VUITTON PROMOTIONAL ITEMS,

comprising 2012 Serenissima Run: a pair of blue leather LV deck shoes (size 10½) in cloth bags and LV box, two exclusive LV board games, a poster for the event (rolled in a plastic tube), a LV leather wallet, a silk pocket square, three items of clothing and a baseball cap; 2006 Boheme run: leather documents case and two polo shirts; with assorted LV badges, ties, and an Italia Classica luggage label.
(Qty)

£1,000 - 1,200
€1,100 - 1,400

105
A SILVER CASED CARRIAGE CLOCK WITH ENGRAVED DEDICATION TO H. VINCENT HERMON AND BROOKLANDS, HALLMARKED BIRMINGHAM 1906,

white enamel dial with Roman numerals, French movement (loose in clock), the inner back door engraved "In remembrance of H Vincent Hermon Aged 25 Years. Died September 14 1907 Brooklands Motor Track Weybridge", 7.5cm high overall.

£1,000 - 1,500
€1,100 - 1,700

Horace Vincent Hermon born 27th July 1882 at Hartford, Cheshire, the third son of Samuel and Charlotte Hermon of Wargrave, Cheshire.

The Fourth Open Meeting at Brooklands was held on 14 September 1907. The meeting was marred by a bad accident which happened at the end of the sixth race. The Napier driven by Smith completed over two miles with the left-hand front tyre missing. Several spokes in the Rudge-Whitworth wire wheels were broken, although the wheel did not run out of true or collapse. Just after leaving the straight the Napier was pulled up in about the middle of the track. The Kaiser Prize Minerva driven by H. V. Hermon in the place of Moore Brabazon ran very fast after passing the finishing line, and the driver apparently failed to see the Napier on the track and swung out too wide, this running high up on the banked turn. The result was that the right-hand rear wheel actually got right over the upper edge of the track, and in endeavouring to correct the car it was turned broadside on and finally toppled down the track, rolling over in the process. The car was wrecked, both back wheels smashed, and the frame and axles bent, while the driver and mechanic were thrown out on to the cement surface. At the time it was feared that both were killed, but eventually they were brought into the Brooklands paddock on the ambulance. The mechanic was reported

not seriously hurt, but Mr. Herman succumbed to his injuries some hours later at the Hand and Spear Hotel, Weybridge.

Thus H V Herman became the victim of the first motor racing accident at Brooklands to claim a life.

106
TWO SILVER WINE BOTTLE STANDS PRESENTED AS PRIZES AT BROOKLANDS IN 1921 BY THE ESSEX MOTOR CLUB,

hallmarked London 1894, pierced ornate base with birds in a floral decoration, each later engraved 'Essex Motor Club Brooklands August 13 1921 H Merton Second Prize', stamped underneath Goldsmiths & Silversmiths Company, each 10.5cm high, 11cm diameter, (some denting to rims).

(2)
£1,000 - 1,200
€1,100 - 1,400



109

107
**A CASED BRITISH ROYAL NAVY 10 X 70
 BINOCULAR GUNSIGHT BY ROSS OF
 LONDON, 1946,**

of the type used on British warships in World War II, military grade steel case painted khaki, marked with Patent No.'G.367 No.123755' and bearing War Dept broad-arrow and National Physical Laboratory number 'NP46', with focus adjust controls and lens filter, lacking eye-cups, contained in original green painted wooden case, with steel mounting plate, offered together with a Gandolfi of London wooden adjustable tripod.

£1,000 - 1,500
 €1,100 - 1,700

108†
**A CASED SET OF STERLING SILVER
 COMMEMORATIVE MOTORING INGOTS
 BY JOHN PINCHES, 1970S,**

produced in the mid-1970s for the Beaulieu National Motor Museum, the wooden case with lid opening to interior fitted with 36 ingots, each hallmarked London and struck with image of veteran, vintage or pre-War road or race car including Alfa Romeo, Bentley, Bugatti, Hispano-Suiza, Mercedes-Benz, and others, each ingot 52mm wide and weighing approximately 68gms, all contained within a fitted wooden case 41cm wide, complete with key.

£2,000 - 2,500
 €2,300 - 2,800



110

109◇
A MR BIBENDUM PROMOTIONAL SUIT,
 believed mid 1990s, full-size suit comprising lower half with braces zip-fastening to upper torso with zip-fastened arms, and head complete with black plastic 'spectacles' and a 'Michelin' sash, together with a pair of white zip-fastening boots, a pair of modern white cotton gloves, and a large vinyl bag for transportation.
 (9)

£2,000 - 3,000
 €2,300 - 3,400

110◇◇
**A LARGE TRIPOD-MOUNTED IBAK
 SEARCHLIGHT WITH ALDIS SIGNAL,
 GERMAN, 1988,**

marine-type D9601 SW 450M searchlight, cast alloy drum casing, with 41.5cm diameter clear lens, with single LED light (450W output), fitted with disc reflector, and with crank handles operating Aldis type signalling black shutters, twin positioning handles to rear of case, fitted within alloy adjustable gimbal mount, and seated within a 360 degree swivel mount on a tripod with height adjustable wooden legs with brass and alloy adjustable fittings, for domestic use and wired for illumination.

£2,000 - 3,000
 €2,300 - 3,400



111



112

111†
**A SILVER-PLATED ROLLS-ROYCE
 PRESENTATION ASHTRAY,**

by Goldsmiths & Silversmiths Ltd of 112 Regent St, London, and stamped to underside, circular bowl with rim engraved with 'RR' monogram logo, with central miniature Spirit of Ecstasy mascot after Charles Sykes, 16cm diameter, believed to have been formerly presented to Henry 'Sft' John Swift OBE, of Thorpe House, Littleover, Derby, former Overall General Manager of Rolls-Royce Ltd Aero Production, retired in 1952.

£1,000 - 1,500
 €1,100 - 1,700

112
**A FERRARI 275 LONG NOSE DESKPIECE
 BY DAUM OF PARIS,**

moulded crystal half profile, engraved 'Daum France' to side of base and with Daum sticker to underside, 23cm long.

£1,200 - 1,600
 €1,400 - 1,800



113†

A SUPERB TRAVELLING COCKTAIL SET IN THE FORM OF A 1920S AEROPLANE, BY J A HENCKELS ZWILLING OF SOLINGEN, GERMANY, CIRCA 1928,

polished nickel-plated brass cocktail set inspired by the romance of air travel, in the form of a stylised 1920s monoplane, featuring 'fuselage' with 'twin-blade propeller' mounted 'cowling' cap, and pair of hip-flask 'wings', the whole fully disassembling to reveal full complement of drinking accessories, the 'fuselage' cocktail shaker with strainer/lemon squeezer and lid, containing drinks flask and set of four gilt-lined stacking cups and funnel, with set of four spoons stacked within the wheeled 'under-carriage' and corkscrew contained in the 'tail-plane', the strainer marked 'D.R.G.M. 894384 Made in Germany', and each cup marked 'Germany' to base, a rare larger example of the two versions originally produced, and measuring 32cm long overall, offered together with an edition of Simon Khachadourian: *The Cocktail Shaker - The Tanqueray Guide*, published 2000 by Philip Wilson, featuring images of a similar cocktail set (see pages 44-45).

(2)

£15,000 - 20,000

€17,000 - 23,000



114†

A 'RALLYE DU MONT BLANC BUGATTI' BRONZE SCULPTURE BY AUGUSTE ZHORENNSEN, CIRCA 1928,

signed to rear and numbered 46 under base, bronze cats in two parts, depicting an early racing Bugatti number 8 driving under a triumphal arch, 30cm high.

£2,000 - 2,500
€2,300 - 2,800

A similar Bugatti bronze is illustrated on page 130 of John J Zolomij: The Motor Car in Art.



114



116

115†

A FINE AND IMPRESSIVE 'CONQUETE DE L'AIR' SHOWROOM BRONZE DESKPIECE FOR FARMAN CARS AFTER GEORGE COLIN, FRENCH, CIRCA 1911,

comprising central hollow-cast bronze depicting the mythical winged figure Icarus with wings spread taking flight from a rocky outcrop, signed 'G.Colin' to side of base and bearing Contenot-Lelievre foundry stamp and '8421' foundry number to rear, flanked by hollow-cast bronze eagle and vulture perched with wings outstretched, mounted on original dark green marble plinth incorporating shallow pen well and two concealed inkwells with original liners, the whole raised on brass feet and measuring 38cm high, 48cm wide.

£3,000 - 4,000
€3,400 - 4,500



115

116†

A 1977 ROLLS-ROYCE AND BENTLEY MOTORS PRESENTATION 50 YEAR COMMEMORATIVE STERLING SILVER SALVER,

hallmarked Sheffield, 1977, by Roberts and Dore Ltd, and with Queen Elizabeth II Silver Jubilee mark, silver salver raised on three feet, bearing Rolls-Royce emblem and further engraved 'To commemorate 50 years association with ROLLS-ROYCE and BENTLEY MOTOR CARS - DUTTON-FORSHAW (PRESTON) LIMITED - 26th October 1977', presented to the head of the Preston based main Rolls-Royce dealership, the salver 25.5cm diameter.

£1,000 - 1,500
€1,100 - 1,700

117

FOURTEEN PRE AND POST-WAR MEDALS AND AWARDS PRESENTED TO AC CARS,

comprising seven 1920s race medals awarded to AC cars at various club and trials events, one bronze, three silver and three gold medals of various sizes, including a 1924 Porthcawl Speed Trials Fastest Time of Day bronze medal awarded to S.F.Edge, and seven cased Earls Court Motor Show 'Private Coachwork Competition' sterling silver medals by Fattorini & Sons, hallmarked Birmingham, three 2nd place and four 1st place medals awarded to AC cars from 1955-1961.

(14)

£1,000 - 1,500
€1,100 - 1,700



117

117

For details of the charges payable in addition to the final Hammer Price of each Lot please refer to paragraphs 7 & 8 of the Notice to Bidders at the back of the catalogue.



118

118
A COLLECTION OF TROPHIES AWARDED TO ROY SALVADORI,

comprising a silver trophy cup: H Philips, London 1956, scroll handles with mask terminals, engraved for The REDEX Trophy Race Closed Cars Under 1300 CC, Oulton Park, 25th September 1959, on plastic plinth, height 10.5cm excluding plinth, 5oz, and 5 silver plated trophies: a plated trophy cup: twin-handled, engraved for W.E.C.C. Boreham, June 1952, Jaguar Trophy Race, 2nd R Salvadori, height 9cm; a plated trophy cup: twin-handled, engraved for W H & D C C, Ibsley Race Meeting, 1954, Closed Cars Over 1500 CC, 1st R F Salvadori, on Bakelite plinth, height 17cm excluding plinth; a plated trophy cup: twin scrolled handles, applied enamel plaque for BRDC, engraved for Fifteenth International Trophy Meeting, 11th May 1963, Sports Car Race, 1st, on Bakelite plinth, height 28cm excluding plinth; a plated trophy cup: twin-handled, engraved for Thruxton Circuit Road Race, 1st Place, on Bakelite plinth, height 16cm

excluding plinth; and a plated trophy cup: twin-handled, engraved for Autosport Championship 1963, 1st Class G, on Bakelite plinth, height 7cm excluding plinth; together with a pewter tankard: made by Crown & Rose of London, engraved for 'The Lord's Taverners, Grand Prix de l'Auberge, The Lord's Taverners' Ball 1959, Presented to Roy Salvadori', height 11.5cm; a plated salver: pie-crust rim, engraved with BRDC shield and presented to Roy Salvadori at the Coys International Historic Festival, presented by Chrysler, Celebrating 50 years of Ferrari, Silverstone 1997, diameter 32cm; three limited edition monochrome prints after Alan Fearnley of Roy Salvadori, signed, inscribed and dated '01 (all printed) and numbered 11, 12 and 13/250, unframed, 30 x 40cm. (Qty)

£1,100 - 1,400
 €1,200 - 1,600



119



120

119
AN 'ADAC WAGENFAHRT 1913' MOTORING THEMED DESK INKWELL BY WMF, GERMAN, PRESENTED AS A MOTORING TROPHY,

pewter inkwell with traces of silver plating, in the form of an early race car with driver and co-driver, the hinged bonnet opening to reveal small tray for nibs and stamps, and the rear opening to compartment containing glass inkwell, with ADAC applied enamel badges to bonnet and rear and '1913' enamel plaque to radiator, the bonnet also engraved 'A.D.A.C. Wagenfahrt 1913', with integral pen-tray, the edge of the base bearing German maker's marks '[*][B][WMF][I/O][ox]', measuring 37cm wide overall.

£2,000 - 3,000
 €2,300 - 3,400



122



122 (detail)

120

THE 1967 LADY WIGRAM TROPHY WON BY JIM CLARK,

Awarded to Clark for winning the Motor Racing Club's 100 Mile Race, 1967, in his Lotus Climax V8, the twin handled 'Windsor' nickel silver plated cup with removable lid, (handles detached at top fitting), standing 56cm in height, with engraving to the front, and mounted on a black plinth, together with a pair of Jim Clark's goggles, a print of a photographic portrait, depicting Clark with goggles round his neck common mounted with a Jim Clark autograph, a copy of Autosport January 27 1967 which contains a two page article "Jim Again at Christchurch", pages 132-133 with race report of how this trophy was won, a Jim Clark Trophy Collection booklet and photocopied pages from Car and Driver reporting on the 1967 Tasman Series.

(Qty)

£6,500 - 7,500
€7,400 - 8,500

See lot number 98 Bonhams Monaco Auction number 13162 on 16 May 2005.

121◇

GREGORY PERCIVAL (BRITISH 1964-), 'TALLY-HO!', SCULPTURE OF DOUGLAS BADER'S 'DOGSBODY' SECTION 616 SQUADRON FLYING FROM RAF WESTHAMNETT IN JULY 1941,

in honour of the brave pilots who flew so gallantly during the Second World War, a limited edition sculpture, signed by the artist and numbered 14 of 25 examples produced, depicting the Spitfires of Douglas Bader, Alan Smith, Johnnie Johnson and Hugh 'Cocky' Dundas, following the call of Bader 'Tally-Ho!', each hand-cast solid bronze Spitfires with a wingspan of 18cm, mounted on clear cast glass resin base to represent the flight trails, measuring 72 x 46 x 35cm overall, offered with certificate of issue from the sculptor.

£2,000 - 3,000
€2,300 - 3,400



123



121

122◇

GREGORY PERCIVAL (BRITISH 1964-), 'ENDURANCE', A PATINATED BRONZE SCULPTURE OF THE 'STEVE MCQUEEN' 1970/71 LE MANS PORSCHE 917K,

limited edition, numbered P004/010, produced in tribute to the twice Le Mans winning 24-Hours car as featured in the 1971 film Le Mans starring McQueen, constructed from seven hand patinated cast bronze sections giving a dynamic depiction of the car at speed with race 'wear', lightly inscribed 'Percival P004/010 2018' to inside of front section, with trailing stylised 'wake' in hand-polished clear glass resin, 37cm long, measuring 76cm long overall including 'wake' and mounted on a slate display base, offered with certificate of issue from the sculptor.

£2,500 - 3,500
€2,800 - 4,000

123*

SEBASTIAN FAULKS: DEVIL MAY CARE; A SIGNED LEATHER-BOUND BENTLEY SPECIAL SERIES EDITION OF THE JAMES BOND '007' NOVEL, 2008,

deluxe bound in brown leather hard covers with embossed spine and red diamond lattice stitched decorative covers and Bentley 'Winged B' emblem to front cover, of the Bond novel by Sebastian Faulks writing as Ian Fleming, and signed by Faulks to title page and dated May 28th 2008, published by Penguin Books in association with Bentley Motors, a Special Series edition numbered 010 of 300, 397 numbered pages and incorporating within cut-out section of the pages a 1:43 scale pewter model of James Bond's Bentley Mark VI Special, the book contained within a Perspex slip-case.

£1,000 - 1,500
€1,100 - 1,700



124

124*

A BENTLEY DIRECTOR'S EDITION SET OF REPRINTED LE MANS SUCCESSES BOOKLETS PRESENTED TO BENTLEY BOARD MEMBERS, 2003,

titled 'Bentley - The Racing Legacy', studied as a single volume with dark-green card covers, containing reprinted editions of Bentley Le Mans successes brochures originally issued 1927-1930, each in dark-green envelope and comprising 'Le Mans 1927', 'Again 1928', 'The Hat Trick' for 1929, and 'Plus Four' for 1930, and a 'Team Bentley Le Mans 80 Years' booklet for 2003, with the Le Mans 2003 Complimentary Dinner Menu included in the set and featuring a reprinted page of the original 1927 Savoy Hotel Complimentary Dinner menu with facsimile signatures of the Bentley Team and drivers, signed by the 2003 Le Mans drivers, presentation framed and offered with the lot.

(2)

£1,000 - 1,500
€1,100 - 1,700

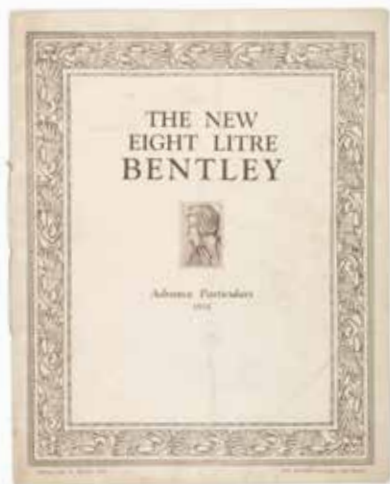

126



125



127

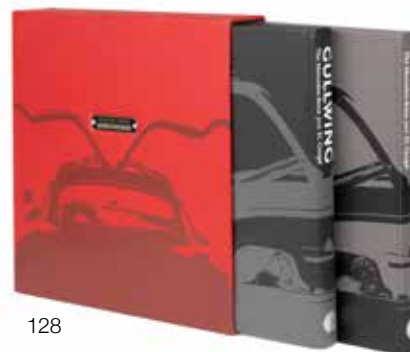

128



129



130

125*
FIVE BENTLEY REFERENCE BOOKS,
 comprising Michael Hay: The Vintage Years 1919-1931, (2nd edition); Clare Hay: The Vintage Years in (three volumes), Clare Hay: Chassis 141, The Story of the First Le Mans Bentley; W.O. Bentley: Illustrated History of the Bentley Car; and The Technical Facts of the Vintage Bentley, 1956 published by the Bentley Drivers Club.
 (5)

£1,000 - 1,200
 €1,100 - 1,400

126*
A 'NEW EIGHT LITRE BENTLEY' ADVANCED PARTICULARS 1931 BROCHURE,
 cord-bound, brochure No.34, dated October 1930, printed by Herbert Fitch & Co.Ltd', 15 numbered pages, illustrated with details and specifications, 4to, with dealer's stamp to back cover.

£1,000 - 1,200
 €1,100 - 1,400

127
A GOOD COLLECTION OF SEVENTEEN PRE-WAR DONINGTON PROGRAMMES,
 all 8vo, some with rusted staples and some wear, from 1935 to 1939 including The Nuffield Trophy, International 200 Mile Race, British Empire Trophy Race, RAC International TT Race and others, (various conditions, 4 Sept 1937 programme has taped repair to covers, worn), contained in plastic sleeves in a ring bound folder.

£1,000 - 1,500
 €1,100 - 1,700

128*
ANTHONY PRITCHARD: 'GULLWING' THE MERCEDES-BENZ 300 SL COUPE/ BOOK OF CARS, 'OWNER'S EDITION',
 published by Palawan Press, two volume set in slip case, applied with engraved plaque limited edition 51/500 for chassis number 5500810, together with correspondence from the author addressed to John Young.
 (Qty)

£1,000 - 1,500
 €1,100 - 1,700

129*
STEPHEN ARCHER & SIMON HARRIES: ASTON MARTIN ZAGATO; A LEATHER-BOUND SPECIAL EDITION PUBLISHED BY PALAWAN PRESS, 1998,
 bound by The Wyvern Bindery of London in black Morocco fine grain goatskin with embossed silver blocking to the front and spine, with stainless steel plaque to front cover engraved with limited edition number '109' of 175 'Special Editions', 408 numbered pages, a detailed history of the 20 DB4GT Zagato bodied models produced, well illustrated with photographs by Richard Newton, in good order with little signs of use, contained in a silver buckram drop-back presentation library box.

£1,200 - 1,400
 €1,400 - 1,600

130*
CHRIS NIXON: 'RIVALS', A RARE DELUXE LIMITED EDITION LEATHER BOUND BOOK IN PRESENTATION CASE,
 number 10/100, 327 numbered pages relating to the rivalry between Aston Martin DBR1 and Ferrari Testa Rossa 1957-1959, published by Surfbrook Ltd in 1998, bound in leather, large 4to, together with un-illustrated paperback book of the same title, complete with Schedoni leather lined riveted metal alloy case, applied with silver marque badges by Asprey to front cover and closed with Schedoni leather belts, together with a red quilted Schedoni carrying bag, three posters depicting Ferrari and Aston Martin car cut-away illustrations (rolled in a tube) and related ephemera.
 (Qty)

£2,800 - 3,500
 €3,200 - 4,000

A SUPERB COLLECTION OF ORIGINAL OFFICIAL FERRARI YEARBOOKS FOR 1930-1933 AND 1949-2013,

two pre-War Yearbooks and a consecutive run of post-War Yearbooks for 1949 to 2013 and comprising:

1930-31-32 - 'Scuderia Ferrari Il 3 Anno di Corse', three year edition, stud-bound card covers with yellow card spine, printed Modena November 1932, 86 pages, with colour pages of advertisements including Ferodo, Italian text, 8vo.

1930-31-32-33 - 'Scuderia Ferrari Il Quarto Anni di Corse', four year edition, soft card covers, printed Modena December 1933, with colour pages of advertisements and maps of Europe/Africa and Italy, Italian text, 4to. (From the Jean Sage Collection)

1949 - cream card covers, one of 6000 printed, including fold-out colour race map of Europe and Tipo 125 fold-out cutaway diagram to rear, Italian text, 4to.

1950 - staple bound paper covers, 6 pages, one of 6100 surviving examples of 7500 originally printed, with Enzo Ferrari name card stapled to front cover with hand-written annotation in purple ink from Enzo "...molti auguri per il 1951", Italian text, 4to. (from the Jean Sage collection)

1951 - cream card covers, one of 2000 printed, with semi-transparent inner covers, 38 pages, with Tipo 500 F2 fold-out cutaway diagram, Italian text, 4to.

1952 - card covers, one of 2000 printed, 40 pages, with fold-out race activity page featuring colour map, Italian text, 4to.

1953 - plasticated card covers, one of 1500 printed, 33 pages, with fold out page featuring 500 Mondial, 375 Mille Miglia and 375 America, and with Enzo Ferrari name card stapled to page 7, Italian text, 4to.

1954 - two editions, one with card covers, of 1100 printed, with Enzo Ferrari name card with greeting stapled to 3rd page, the other with plasticated card covers, of 1400 printed, both Italian text, 4to.

1955 - card covers, 43 pages, Italian text, 4to.

1956 - card covers, 44 pages, one of 1000 printed, Italian text, 4to.

1957 - 10 Year Anniversary edition, card covers, one of 950 printed, 69 pages, Italian text, 8vo.

1958 - card covers, one of 800 printed, 65 pages, with Enzo Ferrari name card affixed to title page with hand-written greeting in purple

ink "una bacchi cari saluti et auguri dicembre 1958", Italian text, 4to.

1959 - plasticated card covers with canvas spine, one of 700 printed, 71 pages, with Enzo Ferrari name card bearing printed greeting, Italian text, 4to.

1960 - plasticated card covers, one of 600 printed, 66 pages, with 'Dott.Ing. Enzo Ferrari' name card stapled to title page, Italian text, 4to.

1961 - plasticated card covers, one of 600 printed, 66 pages, with Enzo Ferrari name card stapled to title page, Italian text, 4to.

1962 - card covers, one of 700 printed, Italian text, 4to.

1963 - card covers, one of 450 printed, 54 pages, with blue card final page bearing Cavallino emblem, Italian text, 4to.

1964 - card covers, one of 400 printed, 64 pages, with brown card divider page and Enzo Ferrari name card with printed greeting, Italian text, 4to.

1965 - card covers, one of 400 printed, 72 pages, with Enzo Ferrari name card with printed greeting stapled to title page, Italian text, 4to.

1966 - special edition with heavy card covers, one of 500 printed, signed to title page by Enzo Ferrari in purple ink, Italian text, 4to.

1967 - 20 Year Anniversary edition, card covers, one of 350 printed, 63 pages, with half-page inner cover, Italian text, 4to.

1968-69-70 - three year edition, plasticated card covers, one of 400 printed, 108 pages, Italian text, 4to.

During the 1970s, official Ferrari annual publications were produced for only selected years, with 1971, 1973 and 1976 having no official editions, however unofficial editions by other publishers were issued for selected years during this period.

1972 - rare Official 2-page card pamphlet with yellow cover, one of 1000 printed, Italian text, large 4to.

1974 - Official Edition, red hard covers, one of 750 printed, with Enzo Ferrari printed signature to title page, Italian text, 4to.

1975 - two editions, the first Official Edition with yellow canvas hard covers, one of 200 printed, with inside fold-out page, the second unofficial edition published by Fratelli Fabbri, card covers, one of 30 printed, both Italian text, 4to.

1976 - unofficial edition published by Arexons, card covers, with front cover depicting James Hunt in the McLaren, and with pull-out full colour folded supplement featuring Hunt and Niki Lauda in the Ferrari 312 T2, Italian text, 4to.

1977 - published by Arexons in collaboration with Ferrari, card covers, of 150 printed, Italian text, 4to.

1978 - published by Arexons, card covers, one of 150 printed, Italian text, 4to.

1979 - published by Arexons, card covers, one of 120 printed, Italian text, 4to.

No official Yearbooks were published from 1980 to 1988, however an edition was printed for the 1984/85 season, and while not official, is considered as such by collectors.

1984/85 - published by EPA of Paris, blue hard covers with dust-jacket, Italian, English and French text, 4to.

1989 - card covers, one of 200 printed, Italian text, 4to.

1990 - two editions, card covers, each of 200 printed, one Italian and one English text, 4to.

1991 - card covers, one of 150 printed, English text, 4to.

1992 - card covers, one of 150 printed, English text, 4to.

1993 - two editions, card covers, each of 150 printed, one Italian and one English text, 4to.

1994 - two editions, each card covers, one Italian text, of 150 printed, and one English text, of 250 printed, 4to.

1995 - two editions, each card covers, one English text, of 120 printed, and signed with dedication by Eddie Irvine to title page, the other Italian text, of 90 printed, 4to.

1996 - two editions, each card covers, each of 80 printed, one Italian and one English text, 4to.

1997 - two editions, each card covers, one Italian text, of 150 printed, the other English text, of 180 printed, 4to.

1998 - two editions, each card covers, each of 80 printed, one Italian text, the other English text, 4to.

1999 - card covers, one of 95 printed, in Italian and English text, 4to.



2000 - card covers, one of 120 printed, in Italian and English text, 4to.

2001 - card covers, one of 90 printed, in Italian and English text, 4to.

2002 - card covers, one of 120 printed, in Italian and English text, 4to.

2003 - card covers, one of 80 printed, in Italian and English text, 4to.

2004 - card covers, one of 80 printed, in Italian and English text, 4to.

2005 - card covers, in Italian and English text, 4to.

2006 - card covers, in Italian and English text, 4to.

2007 - card covers, in Italian and English text, 4to.

2008 - card covers, English text, 4to.

2009 - card covers, English text, 4to.

2010 - card covers, English text, 4to.

2011 - card covers, English text, 4to.

2012 - card covers, English text, 4to.

2013 - card covers, English text, 4to.

(64)

£20,000 - 25,000

€23,000 - 28,000



132



132



133

SPEED RECORD COLLECTABLES

132

TWO RARE H. O. D. SEGRAVE WORLD LAND SPEED RECORD CORD TIED BOOKLETS,

comprising:- '203m.p.h. The Supreme Sunbeam', printed 1927, brown card covers printed in orange embossed text on grey ground, 4to, 24 pages celebrating Segrave's new World Land Speed record of 203.7928mph in the 1000HP Sunbeam; and 'The Souvenir of the Dinner given by the British Racing Drivers Club to Major Sir Henry Segrave and Capt J S Irving in honour of the attainment of the speed of 231 m.p.h.', a souvenir menu, small 4to, light card cover with printed 'Golden Arrow' onion skin cover, 4 pages, some creasing and wear to onion skin.

(2)

£1,000 - 1,500

€1,100 - 1,700

The 'Golden Arrow' menu for the event held on 29 April 1929 is believed to be the first ever event conducted by the newly formed British Racing Drivers Club, the now famous club badge, which had only been approved one month before this menu was printed, decorates the back cover.

133

A COLLECTION OF H. O. D. SEGRAVE PRINTED EPHEMERA, PHOTOGRAPHS, PHOTOGRAPHIC POSTCARDS AND A SEGRAVE TROPHY BOOKLET

comprising a signed menu for the Dinner held at the Grand Hotel Birmingham, 16 May 1929, signed in pencil to front 'HOD Segrave' with an invitation to the same; a menu for the luncheon given by Sir Charles Cheers Wakefield in honour of Major H.O.D. Segrave at the Connaught Rooms, St Georges Day 1929, with separate guest list & table plan; nine motoring photographs including the 1000hp Sunbeam at Brooklands under police guard, Segrave and Britti Peri at Monza in 1926; Segrave with Cotalen and other drivers in the pits, and other

images, various dates, one framed and glazed; 10 post cards part of a scarce set published by Herbert depicting the two successful World Water Speed record attempts on Lake Windermere taking the record up to a speed of 98.76mph on 13 June 1930, and views of the last voyage of Miss England II and her fated crew; 'The Spirit of Adventure' booklet about the creation of the Segrave Trophy; a 1977 sepia tone print depicting the 1000hp Sunbeam at Daytona, 21 x 27cm, mounted, framed and glazed (loose in frame); and other printed, scanned and photocopied ephemera. (Qty)

£1,000 - 1,500

€1,100 - 1,700

Lots 134 to 138 were collected for many years by the Late Christopher Jackson. Mr Jackson was the Managing Director of Metro Imaging a photographic company based in Clerkenwell. He had a keen interest in the engineering, patriotism, drive and bravery of the 'Racing Campbells' and combined this with a love and knowledge of fine photography to compile this collection.



134

134

A WALL CLOCK BY THE HAMBURG AMERICAN CLOCK COMPANY FROM MALCOLM CAMPBELL'S WORKSHOP AT POVEY CROSS, 1920S, FORMERLY THE PROPERTY OF THE LATE LEO VILLA,

white 8 inch diameter dial, black painted Roman numerals, with crossed arrows design (pre-1926), flat glass lens in nickelled bezel, in wooden case, the movement with detachable Pendulum, together with two scanned images depicting the workshops and a letter of provenance.

£1,000 - 1,500

€1,100 - 1,700

This clock was purchased from the Leo Villa Collection auction 23/24 July 1992 at Neales of Nottingham as lot 853. In 2004 the auction purchaser sold the clock privately to the current vendor's father, by descent to the vendor.



135 (part)



136 (part)



137 (part)



137 (part)

135
TWO FRAMED MALCOLM CAMPBELL PHOTOGRAPHS MOUNTED WITH SIGNATURES,

comprising a studio portrait by R H LeSesne, monochrome 9 x 8 inches, common mounted with Malcolm Campbell autograph in ink on paper, framed; and a side profile view of Bluebird at Daytona 1931 with Campbell and the Racing Officials, by Coursen's Ivy Lane Studio, monochrome 3 x 9 inches, the car that broke the World Land Speed Record on 5 Feb 1931 taking the new record to 246.09mph, common mounted with Malcolm Campbell autograph in ink on cut-out scrap of blue paper, framed; together with a signed Milton Post Card portrait of Campbell in a dark suit, signed "With my best wishes Malcolm Campbell" in blue ink. (3)

£1,000 - 1,500
 €1,100 - 1,700

136
A COLLECTION OF MALCOLM CAMPBELL AND BLUEBIRD PHOTOGRAPHS,

including five LeSesne prints of 1932 and 1935 at Daytona; a 1935 Daytona image by C E Grenell with envelope; a 1935 image of the team hand written "To Ferdie from Leo, Daytona, 7.3.35"; fifteen images from an album of a Bluebird team member from South Africa 1929, mounted on hole punched pages with annotated notes, including Campbell bowling in a game of cricket; six photographs of Campbell, Bluebird K4 and the World Water Speed Record Team from 1939; and other images including six modern prints of other WLSR cars, two magazine advertisements, two post cards, majority unmounted in acid-free sleeves together with a cigarette case with picture of Bluebird in 1935 on the front case and engraved 'Daytona Beach 276.8mph' on the back, contained in an archive box. (Qty)

£1,000 - 1,400
 €1,100 - 1,600

137
A QUANTITY OF DONALD CAMPBELL LAND SPEED RECORD PHOTOGRAPHS, EPHEMERA AND COLLECTABLES,

comprising a signed portrait of Campbell at Goodwood with Bluebird in 1962, monochrome 8 x 10 inches, written "To: Edward McDonough with Best Wishes from Donald Campbell"; with over thirty five other images, all unmounted in acid-free sleeves, contained in an archive box, together with a framed and glazed photograph depicting CN7 at Goodwood in 1960 by Edward Eves, other images including social scenes, water-skiing, etc..., other ephemera including a signed letter on personal letter-headed paper dated 20th October 1965, a 1962 Blue Bird dinner menu in honour of Donald Campbell, a 1960 letter addressed to Donald regarding the Bluebird trials from Ken Norris, a sheet of Bluebird stamps, a framed and glazed front page of 'The News' dated Adelaide July 17 1964 with the headline 'Campbell Does It 403.1mph' and other printed ephemera, together with three models of the Proteus Bluebird, a boxed Corgi Toy number 153 Proteus-Campbell-"Bluebird" Record Car, an unboxed model of John Cobb's Railton and a 403.1mph booklet relating to the same. (Qty)

£1,000 - 1,400
 €1,100 - 1,600



138 (part)

138
A QUANTITY OF DONALD CAMPBELL WATER SPEED RECORD PHOTOGRAPHS, EPHEMERA AND COLLECTABLES, comprising a signed K7 postcard "To Ken with Best wishes from Donald Campbell" in blue ink (smudged), two images signed Best Wishes Geoff Hallawell, other assorted images all unmounted, majority in acid-free sleeves, contained in an archive box; together with a Vane off the K7 wreckage (corroded), with two flakes of Bluebird paint and a series of modern images of the salvaged wreckage before restoration began; a signed letter on personal headed paper dated 9 February 1960 addressed to Leslie Hackett of Accles & Pollock Limited; a 1957 Donald Campbell Christmas card; other photographs including five framed and glazed, other ephemera including booklets and advertisements; a 1956 Mobil press release; a front page of The Evening News announcing Campbell's death, framed and glazed; four Bluebird models (1 x K4, 3 x K7) and a model of Cobb's Crusader and a booklet relating to the same.
 (Qty)

£1,000 - 1,400
 €1,100 - 1,600



139 (part)

OTHER PROPERTIES

139
A COLLECTION OF MALCOLM/ DONALD CAMPBELL LETTERS, CORRESPONDENCE, PRESS CUTTINGS, MAGAZINES AND PRINTED EPHEMERA, including 301.129 menu, cord tied 8to with embossed cover; a letter dated 8 February 1937 to Sir Noel Curtis Bennett from Malcolm Campbell, signed, relating to "a little book on the European Situation" as written by Campbell, together with a copy of The Peril from the Air; a 1934 Christmas Card from Sir Malcolm Campbell with photographic front and rear views of the Blue Bird chassis; one hand-written and seven typed letters signed by Donald Campbell, 3 letters signed by Jean Hulme (Donald's sister); two comprehensive files of correspondence relating to the estate of the Late Malcolm Campbell, other legal matters relating to Donald Campbell, Jean Hulme, Leo Villa and others (with many carbon copies); a typed copy of the draft press release relating to the Segrave Trophy presentation to Donald Campbell; "The Proteus Bluebird" Goodwood July 1962 a printed four page article written by Donald Campbell for the Goodwood Magazine; two Castrol flicker books depicting Malcolm Campbell breaking World's Water Speed Record and George Eyston breaking the World's Land Speed Record in Thunderbolt; a large file of press cuttings and magazines both contemporary and modern: and a set of 24 Top Trump 'Record Breaker' cards.
 (Qty)

£1,000 - 1,500
 €1,100 - 1,700



140 (part)

140
A GOOD COLLECTION OF PHOTOGRAPHS OF "THE RACING CAMPBELLS" AND OTHER SPEED RECORD HOLDERS, over 100 images, including three signed Malcolm Campbell photographs, assorted other images Malcolm Campbell and Blue Bird including a rare image of the failed 1924 record attempt at Faroe Island, Denmark, 1931 Blue Bird at Gurney Nutting coachbuilders, Malcolm Campbell in RFC uniform with FE2b, circa 1917, family images of Donald and Jean playing with pedal cars, the Campbell family with bicycles, Malcolm Campbell at Brooklands Easter Monday 1923; assorted images of Donald Campbell and Blue Bird including the Proteus at Goodwood in 1962, K7 at Coniston, "The Last Thumbs Up" taken on 4 January 1967, at Bonneville 1960, at Ullswater in 1955, detailed engineering images of Blue Bird II cockpit and engine 1960 and other drivers and speed kings including Henry Segrave, Goldie Gardiner, George Eyston, Ken Warby signed and annotated 317.60mph, Frank Hanning-Lee and other drivers, various sizes and conditions, seven matted ready from framing.
 (Qty)

£1,200 - 1,600
 €1,400 - 1,800



141

141
A RARE BOXED TIN-PLATE CLOCKWORK TOY OF CAPTAIN MALCOLM CAMPBELL'S 'BLUE BIRD' LAND SPEED RECORD CAR BY GUNTHERMANN, CIRCA 1931,
 lithographed tinplate in yellow and blue (crazing), 52cm long, with key and original box with decorated lid.

£1,000 - 1,500
 €1,100 - 1,700



142

142
TWO MALCOLM CAMPBELL'S BLUE BIRD TINPLATE CLOCKWORK TOYS, 1928 AND 1935,
 comprising a toy of the Napier-Campbell Blue Bird III by Kingsbury, American, finished blue with silver painted radiators, driver and wheel hubs fitted with Dunlop Cord tyres, 47cm long; and a toy of the Campbell-Railton Bluebird, Made in England, tinplate with fixed key, painted tinplate wheels, lithographed flags and driver, with facsimile signature on cockpit, 42cm long.
 (2)

£1,000 - 1,500
 €1,100 - 1,700



143

143
A SUPERB COLLECTION OF BLUE BIRD TOYS AND GAMES,
 including un-boxed tinplate, die-cast and plastic models of the cars in their various guises, the largest 32cm, the shortest 6cm long; boxed toys and models including two W Britain die-cast models (one with fixed body, the other with removable body displaying engine and chassis), Marx plastic friction drive Proteus Blue Bird with remains of box, a boxed Jetex powered "Two Bluebirds" set of Proteus car and K7 boat, used, box worn; a boxed Sutcliffe "The Bluebird Wonder Speed Boat", clockwork tinplate toy, (box worn); a boxed Sutcliffe Bluebird Speedboat, with coloured design to box lid, tinplate clockwork toy with outriggers, (box worn); a DWB Toys "Superspeed" Race game, boxed with instructions, playing card, counters and lithographed tinplate spinner depicting Schneider Trophy Seaplane, Miss England boat, Silver Jubilee locomotive and Bluebird car; and a Blue-Bird pencil case with faint traces of facsimile Malcolm Campbell signature.
 (Qty)

£1,000 - 1,500
 €1,100 - 1,700



144

144
A 'GOLDEN ARROW' LAND SPEED RECORD BAKELITE CLOCKWORK TOY BY A.G.LTD, PATENTED 1929,
 brown 'Ranlite' Bakelite body, produced by Automobiles Geographical Ltd of Halifax, England, of the Irving Napier-engined car as driven to a new Land Speed Record by Major Henry Segrave in 1929, front right wheel detached but present, front rubber tyres cracked and rear tyres mis-shapen, 42cm long.

£1,500 - 2,000
 €1,700 - 2,300



145

TOYS AND MODELS

145*

A RARE CLOCKWORK TINPLATE MODEL OF AN ALFA ROMEO P2, BY CIJ, FRENCH, 1930S,

type 3 version (without shock absorbers and brake drums), in original silver German National racing colour paintwork and wearing number 2, with wire mesh grille, louvered bonnet with leather straps, the spoked wheels with brake drums, replacement treaded Pneu Michelin solid rubber tyres (originally used on type 2 versions) and knock-off spinners, with opening filler caps, exhaust, and with front wheel steering and operational hand-brake, 52cm long, some general wear commensurate with age, in operational condition at time of cataloguing, lacking key.

£2,200 - 2,600

€2,500 - 2,900

146◇◇◇

AN MG TC CHILD'S CAR BY TIMELESS TOYS, BRITISH, MID TO LATE 1940S,

restored in 1996 by Simon Robinson Classic Car Restoration, battery powered, painted red with chrome lamps, grille and horn, interior trimmed in tan leather, with Walnut veneered dashboard by Staples, wire spoke steering wheel with black rim, flick-switch for forward, neutral and reverse gears, simulated engine noise, wire spoked wheels, with spare wheel to rear, reg number MG TC, 170cm long, in working order, complete with key.

£3,500 - 4,500

€4,000 - 5,100



146



147

147000

A 1:2 SCALE FERRARI 330 P2 JUNIOR CHILD'S CAR,

a good reproduction of the prototype Ferrari built to compete at Le Mans, fitted with a 150cc engine giving a top speed of 20mph, disc brakes, key start, working lights, GRP body, hand-stitched leather interior with diamond stitch inserts, this example was restored in the late 1980s and is in working order but has sat in a collection for a few years, careful recommissioning recommended before use.

£4,500 - 5,500
€5,100 - 6,200

148000

A FORD GT40 'GULF' CHILD'S CAR,

built to inspire and give young drivers a passion for racing, this children's car is modelled after Ford's Le Mans-winning GT40, equipped with a 150-cc petrol engine and can reach speeds of up to 20 mph, vented disc brakes, working headlights and a GRP body over a custom box section chassis, custom hand-stitched leather adorns the interior, with working horn, key start, chrome wheels and spinners, approximately 240cm long x 140cm wide, this example is in working order but has sat in a collection for a few years, careful recommissioning recommended before use.

£4,500 - 5,500
€5,100 - 6,200

149000

A FERRARI F640 CHILD'S CAR, 1989,

with Nigel Mansell's signature, pull start 50cc, 2Hp petrol engine with drive to rear axle, (20 mph max speed can be governed down to walking pace), one of a kind box section chassis, with rose jointed steering, adjustable pedals for throttle and brake, bucket seat, quick-release steering wheel, carbon fibre look floor pan, front and rear wings, removable GRP body decorated with number 21, Fiat, Ferrari, Magnetti Marelli, Agip and Marlboro logos, with Goodyear logos on front wings, slick tyres, approximately 200cm long x 135cm wide, this example is in working order but has sat in a collection for a few years, careful recommissioning recommended before use.

£4,500 - 5,500
€5,100 - 6,200



148



149

For details of the charges payable in addition to the final Hammer Price of each Lot please refer to paragraphs 7 & 8 of the Notice to Bidders at the back of the catalogue.



150

150

A SUPERB ALFA ROMEO 8C 2300 CHILD'S CAR,

hand-built in Germany by skilled engineering Panel Beater, early 2018, powered by petrol engine with Automatic gearbox, 3 meters long by 1 meter wide, 17 in wheels with pneumatic tyres, well detailed dashboard, finished in Rosso Corsa livery, with lights, leather bonnet strap, side-mounted spare wheel, mirror and other equipment.

£5,000 - 7,000
€5,700 - 7,900

The car offered here is a scaled-down replica of one of the greatest Grand Prix cars of all time: The Alfa Romeo 8C Monza. Designed by the legendary Vittorio Jano, the supercharged, eight-cylinder, 2.3-litre 8C first appeared in 1931 in sports car configuration, winning that year's Le Mans race and the Targa Florio. Later that year, the works 8Cs entered by Scuderia Ferrari finished 1st and 2nd in the Grand Prix of Europe at Monza, giving the model its evocative name. Realising that more power would be needed to stay ahead of the opposition, Jano further developed the Monza, enlarging the straight-eight engine to 2,654cc for the

successor P2 single-seater. The P2s dominated the 1932 Grand Prix season but were sidelined for 1933 as a result of Alfa's financial problems. Rescued by the Italian government, the racing programme was back on track in time for the 1934 season but by this time the P2 was facing the more powerful Auto Unions and Mercedes-Benz cars. From then onwards successes were few, Tazio Nuvolari's sensational win in the 1935 German GP at the Nürburgring at the wheel of a P2 being the standout highlight

151

A COLLECTION OF MODEL CARS,

including a 1:24 scale hand-built limited edition 09/50 model of the 1961 Le Mans Ferrari 250 swb Berlinetta as driven by Noblet / Guichet, good detail with opening bonnet and mounted for display within a Perspex case in Tecnomodel box, with plaque and certificate, (rear windscreen detached); nineteen 1:43 scale model Ferraris, the majority 250GT by Bang in plastic cases, six in original boxes, two others by Jouef Evolution, and other assorted toys and models.

£1,000 - 1,500
€1,100 - 1,700



151 (part)

For details of the charges payable in addition to the final Hammer Price of each Lot please refer to paragraphs 7 & 8 of the Notice to Bidders at the back of the catalogue.



152



153



154



155

152*

A 1:20 SCALE MODEL OF THE 1959 DUTCH GRAND PRIX WINNING BRM P25,

hand finished in British Racing Green livery, depicting the car driven to Victory by Jo Bonnier, mounted on baize covered base with engraved plaque, under Perspex cover, 23 x 12 x 10cm.

£1,000 - 1,200
€1,100 - 1,400

153

A FINE 1:20 SCALE SCRATCH-BUILT MODEL OF GRAHAM HILL'S 1968 MEXICAN GRAND PRIX WINNING LOTUS 49B RACING CAR, BY RENOWNED MODEL ENGINEER GERALD WINGROVE

constructed in 1969, number 2 of 2 built, fantastically detailed model of this 1968 Formula 1 Driver's and Constructor's Championship winning car, finished in Gold Leaf sponsor's red, white and gold race livery with hand-painted logos, with full engine, cockpit and suspension detailing, signed underneath "1968 LOTUS FORD built by Gerald Wingrove (MODEL ENGINEER)" the maker's name as engraved signature, with velvet covered base panel with wooden frame inset with plaque engraved with Gerald Wingrove signature, mounted with business card under the base, with a Perspex display case measuring 34 x 18 x 13cm overall.

£1,800 - 2,500
€2,000 - 2,800

Two of these models were constructed by Gerald Wingrove in 1969. The first was for the Montagu collection (National Motor Museum at Beaulieu), subsequently dispersed at auction, (see Bonhams sale 112 on 6 December 1999, lot 16); and the second (this example) a private commission.

"The first of my Ford Cosworth powered winners. Like many others, I was to become very familiar with this engine. A most pleasing and compact piece of machinery to model. The G.P. cars are the only ones I have built in this scale to contain engine detail"

The Model Cars of Gerald Wingrove, see pages 92-93.

154

A 1:10 SCALE MODEL OF THE 1954 GRAND PRIX DE REIMS WINNING MERCEDES W196 "STREAMLINER" BY PATRICE DE CONTO AND BERTRAND BIGAUDET,

kerbside model, mounted and painted by the Belgian model maker Michel Stassart, under display showcase.

£1,500 - 2,000
€1,700 - 2,300

155◇

A FINE 1:8 SCALE HAND-BUILT MODEL OF A PORSCHE 356A SPEEDSTER BY KARSTEN SCHMIDT,

kerbside model of the car, resin body, with detailed cockpit and dashboard, solid tyres, the whole finished in maroon with brown and tan upholstery livery, measuring 46cm long, mounted on a display base with title plaque under a Perspex case, measuring 64 x 31 x 21cm overall, with certificate of authenticity and with carton packing box.

(Qty)

£2,200 - 2,800
€2,500 - 3,200

156◇

A 1:8 SCALE MERCEDES 196 STREAMLINED COACHWORK WALL PLAQUE BY KARSTEN SCHMIDT,

resin sculpture, painted silver, 54cm long, mounted on a display base under a Perspex case, measuring 66 x 72 x 15cm. with certificate of authenticity and cardboard packing box.

(Qty)

£1,000 - 1,500
€1,100 - 1,700



157



158



156



159

157◇

A 1:8 SCALE MODEL OF THE JAMES BOND 007 'GOLDFINGER' ASTON MARTIN DB5,

kit-built, finely constructed from mainly metal parts, originally licensed by both Eon Productions and Aston Martin Lagonda Limited, well detailed model with opening doors, bonnet and boot, finished in 'Silver Birch' paintwork, loaded with all the Bond 'Special Equipment' including machine guns, bullet shield, removable roof section, cutting spinners, and finely modelled interior, 60cm long, offered with a wooden carry-case.

£1,000 - 1,500
€1,100 - 1,700

158◇

A FINE 1:8 SCALE HANDBUILT MODEL OF A PORSCHE 550 SPYDER BY KARSTEN SCHMIDT, SIGNED BY HERBERT LINGE,

kerb side model of the car, resin body, with detailed cockpit and dashboard, solid tyres, the whole finished in silver-coloured race livery with decals and wearing the race number 66, painted in post-race condition, measuring 43cm long, mounted on a display base with title plaque under a Perspex case, (some small marks to inside of case) measuring 64 x 31 x 21cm overall, with certificate of authenticity and with carton packing box.

£2,200 - 2,800
€2,500 - 3,200

159◇

A FINE 1:8 SCALE SCRATCHBUILT MODEL OF THE 1965 FERRARI 250 LM BY JAVAN SMITH,

limited edition kerbside model of the N.A.R.T. Ferrari 250LM, Chassis Number 5893LM driven to victory in the 1965 Le Mans 24 Hour race in the hands of Masten Gregory and Jochen Rindt, build number 10 of only 20 examples of this great sports/racing car, complete with authentication certificate and limited edition certificate, mounted on a Perspex plinth within an etched Perspex display case, overall dimensions 600mm x 270mm x 220mm high.

£2,200 - 2,500
€2,500 - 2,800

160◇

A FINE 1:8 SCALE SCRATCHBUILT MODEL OF THE 1956 GERMAN GRAND PRIX WINNING SCUDERIA FERRARI LANCIA D50 BY JAVAN SMITH,

kerb side model with full cockpit detailing mounted on a Perspex plinth, enclosed within a Plexiglas display case etched with a 'D50' logo and complete with certificate of authentication, overall dimensions: 600mm x 270mm x 220mm high.

Originally the iconic Lancia D50, modified and rebadged as the Ferrari D50 when Scuderia Lancia's assets were transferred to Maranello in 1954. This particular example depicts the 1956 German Grand Prix winning "long nose" D50, the long nose configuration being used for the higher speed circuits during the 1956 season. The Ferrari D50 driven by Fangio, secured him the 1956 Formula One World Drivers Championship.

£2,300 - 2,500
€2,600 - 2,800



160



161



162

161◇

A FINE 1:8 SCALE SCRATCHBUILT MODEL OF THE 1969 LE MANS WINNING FORD GT40 BY JAVAN SMITH,

A scratch built, limited edition kerbside model of the Ford GT40 chassis #1075, one of the world's most celebrated race cars, '1075' has six race victories to its credit, but is best known for winning the Le Mans 24 Hour race, twice - Pedro Rodriguez and Lucian Bianchi drove 1075 to its first Le Mans win in 1968 and the same car winning again in 1969 in the hands of Jacky Ickx and Jackie Oliver. This new model is build number 8 of only 25 examples, mounted on a Perspex plinth within an etched Perspex display case and complete with certificate of authenticity and signed limited edition certificate, overall dimensions 600mm x 270mm x 220mm high.

£2,400 - 2,800
€2,700 - 3,200

162◇◇

3 1/2 INCH GAUGE L.M.S. FOWLER CLASS 4P-D 2-6-4T TANK LOCOMOTIVE "DORIS" NUMBER 2389,

finely detailed engineer's model of the parallel boiler tank engine, finished in LMS maroon livery, 90cm long overall.

£3,000 - 4,000
€3,400 - 4,500

The full size locomotive was built on 31/5/1933 at the LMS Derby Works, weighing in at 86 tons 5 cwt with a 5 foot 9 inch diameter driving wheel. 2389 wore the liveries of LMS from 1933 until 1947 and British Railways from 1948 onwards. 2389 was withdrawn from service on 23/03/1963 and cut up for disposal at the BR Horwich Works on 31/07/1963.



163



164



165

163

3½ INCH GAUGE L.N.E.R. A3 CLASS 4-6-2 "PAPYRUS" NUMBER 2750 MODEL WITH TENDER ENGINEERED BY M CLARKSON OF BARLBY, 1946,

finely detailed engineer's model, finished in L.N.E.R. livery, 85cm long, applied with maker's plaque, complete with matching 8 wheel tender, 54cm long.

(2)

£4,000 - 6,000

€4,500 - 6,800

The full size locomotive was designed by Sir Nigel Gresley and built at the Doncaster Works on 23/02/1929, weighing in at 96 tons 5 cwt with a 56 ton 6 cwt tender. On 5 March 1935 Papyrus became the holder of the World Land Speed Record for Steam Locomotives at 105mph, the first authenticated record breaking run at over 100 mph with complete, surviving documentation. Incredibly Papyrus hit its top speed while hauling 243 tons of cargo behind it. It wore the LNER livery from 1929 until 1947 and British Railways from 1948. It was withdrawn from service on 09/09/1963 and cut-up for disposal on 30/06/1964 by the Arnott Young scrapyard, Carmyle.

164

A 1:4 SCALE SPONSOR'S MODEL OF ALAN JONES' 1980 WILLIAMS FW07B/04,

metal, wood and plastic construction well detailed model in green and white livery applied with sponsors logos, 107cm long, mounted in a later constructed glazed display case with wooden base, 121 x 77 x 42cm overall.

£1,400 - 2,000

€1,600 - 2,300

This model was formerly part of the collection of Leyland Vehicles, sponsors of the 1980 Williams team. When Leyland DAF was formed in 1987 all business, sponsorship and promotional items bearing the old logos were sold off, cleared from the premises or disposed of. This model has been in the present ownership since 1987.

165

A PAIR OF GRAHAM HILL'S HINCHMAN NOMEX OVERALLS, USED DURING THE 1973 RACING SEASON,

cream with distinctive red, yellow and blue stripes on left breast, with Hinchman, and two Goodyear embroidered patches, original stitching of driver's name unpicked by visible on right breast above the zipped pocket, zip fronted with velcro neck fastening and elasticated cuffs and ankles, worn.

£1,000 - 2,000

€1,100 - 2,300

According to information supplied by the vendor these overalls were gifted by Graham Hill to his great friend John Young. John unpicked Graham's embroidered name and applied a later Goodwood patch (now removed) to cover the area so this suit could be used in retro events such as the Goodwood Revival.

See: Ivan Rendall 'The Chequered Flag', page 278-279 for an image of Hill wearing a 1973 Hinchman Nomex suit.

166

**A HERBERT JOHNSON RACING HELMET
FORMERLY THE PROPERTY OF 1958
WORLD DRIVER'S CHAMPION MIKE
HAWTHORN, 1950S,**

size 6 7/8, black peaked shell, with canvas and leather chin strap and neck support, cork lined with webbing bearing maker's label and leather interior, used, fitted with Herbert Johnson visor.

£10,000 - 14,000

€11,000 - 16,000

Formerly the property of Rob Walker until 1968, then owned by Tom Wheatcroft until 1980, when it was gifted to Kevin Wheatcroft for his 21st Birthday. Displayed at the Donington Grand Prix Collection from 1973 until 2005, when the collection obtained another Hawthorn helmet. Sold together with a letter of provenance.



166



167

167

**A 1952 LIGHTWEIGHT RACING HELMET
BY REPUTE FORMERLY THE PROPERTY
OF FIVE TIMES WORLD DRIVER'S
CHAMPION JUAN MANUEL FANGIO,
1950S,**

black lacquer outer, with cork, black leather and black webbing lined shell, black leather chin straps and neck support, used condition.

£30,000 - 40,000

€34,000 - 45,000

This helmet was believed to have been used by Fangio during the 1952 international race season, which began with seven South American races before moving on to Europe. Offered with an unsigned typed letter of provenance in French, with English translation.



(Archive image not for sale with the lot.)



168*

AN ORIGINAL AYRTON SENNA BELL HELMET WORN DURING TESTING AT PAUL RICARD CIRCUIT ON 2ND MARCH 1994

SS type Penske 93-94, SNELL number SA210606, painted by Pierre Van Ginneken in Senna's traditional patriotic Brazilian livery, decorated with Nacional and Bell Helmets sponsors logos, Rothmans Racing blank pattern logo on the forehead and sides of chin-guard, with Renault elf tinted visor, fitted with radio by MRTC for the Williams Team. Offered together with a signed letter from Pierre Van Ginneken, dated Brussels, 11 October 1994, stating that this is the only helmet of this type, painted with this design for Ayrton Senna and a Bell helmet bag.

(3)

£60,000 - 80,000

€68,000 - 91,000

CHARITY LOTS



Wings for Life funds cutting-edge research projects and clinical trials across the globe aimed at finding a cure for spinal cord injury.

Since Wings for Life was first founded, 170 spinal cord research projects have been funded at the world's most well-respected institutes and a number of vital breakthroughs have been made.

The developments so far provide strong hope that treatment options are closer than they have ever been. However, intensive research work will be needed before a breakthrough in human medicine can be achieved.

When you support Wings for Life, 100% of the money you donate will go to directly to spinal cord injury research as the charity's founders generously cover all of the administrative costs.

Wings for Life UK organises a range of fundraising events for their supporters and always welcomes new volunteers. UK Registered Charity No. 1138804 www.wingsforlife.com

169

A 2017 FORMULA 1 SEASON RACE USED TORO ROSSO REAR WING ASSEMBLY, OFFERED FOR SALE ON BEHALF OF WINGS FOR LIFE,

carbon fibre construction, comprising main stem support with rear twin-foil spoiler finished in dark blue with Red Bull sponsor's logo, fitted with vented end-plates in red decorated with 'simply Cola by Red Bull' and other sponsors' logos, and featuring the 2017 season 'DRS' (Drag Reduction System) adjustable mechanism, 95cm wide, some evidence of light race wear in places, fitted to Carlos Sainz Jr.'s Scuderia Toro Rosso STR12 car and race used during the first rounds of the European part of the 2017 F1 season including a 7th Place for Sainz at the Spanish Grand Prix at the Circuit de Barcelona-Catalunya, offered together with Toro Rosso Letter of Authenticity.

(2)

£1,000 - 1,500
€1,100 - 1,700



169

170

A SIGNED LEWIS HAMILTON RACE SUIT - WORN DURING THE 2017 CHINESE GRAND PRIX PRACTICE SESSIONS, OFFERED FOR SALE ON BEHALF OF WINGS FOR LIFE,

by Puma, race suit number 8, in white with aquamarine 'swoosh' to right leg, with Petronas, Puma, Mercedes AMG, Hugo Boss and UBS, sponsors' branding to chest and other sponsors' logos to arms, with 'L.Hamilton' driver name and race number '44' and Union Jack National Flag to waist, small stain to right knee, worn by Hamilton during Free Practice One and Two Sessions prior to the Chinese Grand Prix race, the label to inside of front hem hand-written 'L.Hamilton Fit Test 8' and with FIA hologram label, signed by Hamilton in black marker to left breast at the 2018 Baku, Azerbaijan Grand Prix in April, and mounted within a Perspex glazed full-length framed display, measuring 177 x 74 x 7cm, and offered together with a Mercedes-AMG Petronas Certificate of Authenticity.

(2)

£4,000 - 6,000
€4,500 - 6,800

At the 2017 Chinese Grand Prix on 9th April, Lewis Hamilton qualified in Pole Position and went on to win the race at the Shanghai International Circuit driving the Mercedes AMG F1 W08 Petronas, beating Sebastian Vettel in the Ferrari and Mercedes team-mate Valtteri Bottas into 2nd and 3rd positions respectively, eventually going on to win the Drivers Championship for the fourth time and the Constructors' Championship for the Mercedes Team.

171 - 200
No lots



170

VEHICLE REGISTRATION NUMBERS

IMPORTANT NOTICE

Before bidding on Vehicle Registration number lots, interested parties should make themselves aware of the DVLA's rules and regulations regarding the transfer of vehicle registration numbers. Bidders are also reminded that it is the sole responsibility of the purchaser to check any details of the V750 or V778 document before bidding. The winning bidder must supply Bonhams Automobilia Department with their 'Nominee' details immediately following their payment for the lot, so the form can be sent to the DVLA by the seller and changed by the DVLA accordingly (This can take between 2 to 8 weeks to process). When the change has been done and the form has been forwarded to Bonhams and then onward to the buyer it is most important that they ensure that the registration number is assigned to an age appropriate vehicle within 1 month of the date of receipt of the signed and completed V778 listing their nominee details, Bonhams will not be held responsible for the consequences of any buyer/nominee failing to do so. Buyers Premium is charged at car rates for lots 201 - 210



201

201

**UK VEHICLE REGISTRATION NUMBER
'ROB 110',**

held on DVLA V778 Retention Document
expires 19 07 2027.

£3,000 - 4,000

€3,400 - 4,500



202

202

**UK VEHICLE REGISTRATION NUMBER
'OCU 1',**

held on DVLA V750 Certificate of Entitlement,
expires 19 08 2025.

£5,000 - 7,000

€5,700 - 7,900



203

203

**UK VEHICLE REGISTRATION NUMBER
'24 AR',**

held on DVLA V778 Retention Document,
expires 08 06 2025.

£6,000 - 8,000

€6,800 - 9,100



204

204

**UK VEHICLE REGISTRATION NUMBER
'HSH 9',**

held on DVLA V778 Retention Document,
expires 05 10 2026.

£6,000 - 8,000

€6,800 - 9,100



205

205

**UK VEHICLE REGISTRATION NUMBER
'FAT 11',**

held on DVLA V778 Retention Document,
expires 21 09 2025.

£7,000 - 10,000

€7,900 - 11,000

206

**UK VEHICLE REGISTRATION NUMBER
'1 SVO',**

held on DVLA V778 Retention Document,
expires 07 04 2025.

£10,000 - 14,000

€11,000 - 16,000



206

207

**UK VEHICLE REGISTRATION NUMBER
'8 OR',**

held on DVLA V778 Retention Document,
expires 29 05 2028.

£15,000 - 20,000

€17,000 - 23,000



207

208†

**UK VEHICLE REGISTRATION NUMBER
'21 A',**

held on DVLA V750 Certificate of Entitlement,
expires 18 05 2028.

£50,000 - 60,000

€57,000 - 68,000



208

209

**UK VEHICLE REGISTRATION NUMBER
'S 100',**

held on DVLA V778 Retention Document,
expires 17 02 2026.

£100,000 - 150,000

€110,000 - 170,000



209

210

**UK VEHICLE REGISTRATION NUMBER
'D 2',**

held on DVLA V778 Retention Document,
expires 14 05 2028.

£190,000 - 220,000

€220,000 - 250,000



210

211 - 300
No lots

MOTOR CARS

13 July 2018, 14:00

Images of each lot can be found at
www.bonhams.com/24876

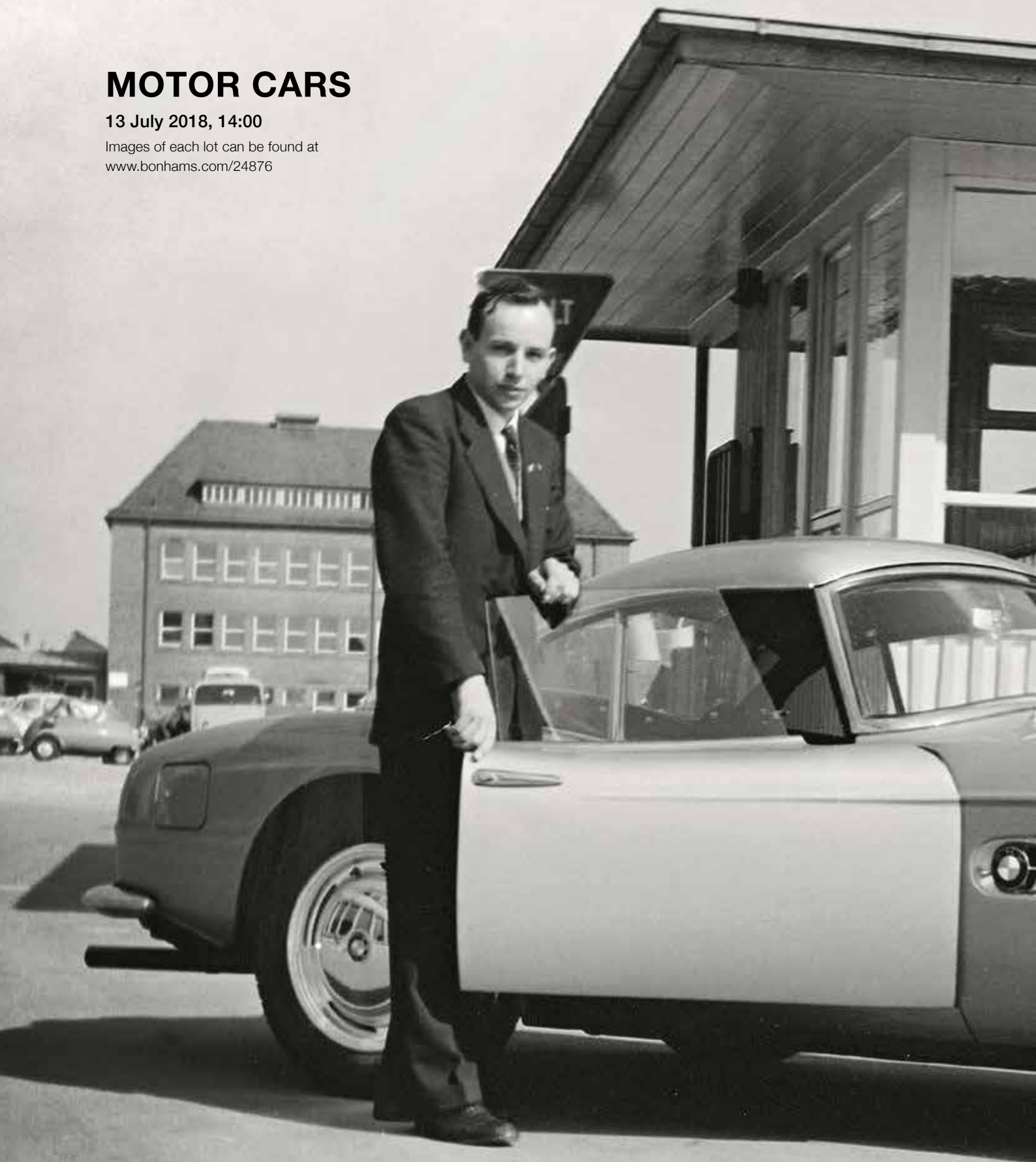



301

From the hit TV drama, 'The Bridge'

1977 PORSCHE 911S COUPÉ

Registration no. Not UK registered

Chassis no. 9117201496

- Driven in *The Bridge* by homicide detective, Saga Norén (Sofia Helin)
- Imported from the USA in 2009
- Left-hand drive
- Manual transmission
- All sale proceeds to WaterAid

Ms Saga Norén (Sofia Helin) from *The Bridge*, alongside her iconic Porsche 911S



© Carolina Romare

'The bleak grey/brown tint through which the Scandinavian drama is filmed seems to have been deliberately chosen to evoke a gritty 1970s look that appears to hark back to the days of *The Sweeney* and *Get Carter*. And the 30-something-year-old car seems to embody the mood of that era; its timeless elegance is in stark contrast to the bland people carrier driven by the other main character...' – Jamie Doward, *The Guardian*.

Offered here is one of the most widely discussed cars of recent TV history: the 1977 Porsche 911S from the hit 'Scandi-noir' series, *The Bridge*. One of the programme's undisputed stars, the Porsche was introduced in the first series of the show, known as Bron/Broen in Sweden, and is driven by its main protagonist, the beautiful and enigmatic homicide detective, Saga Norén. Her exotic choice of car always arouses envy among her colleagues at the Malmö County Police station, fuelling rumours surrounding the mysterious Norén's past.

Now enjoying the same celebrity status as Inspector Morse's Jaguar Mark 2 and Jim Bergerac's Triumph Roadster, Norén's Porsche has inspired a cult-like following among fans of *The Bridge*, with discussion online dedicated to unravelling the story behind the car and its provenance. Online speculation about its identity notwithstanding, the chassis number confirms that this car is a 1977 2.7-litre 911S Coupé built for the United States market.

Imported into Sweden from San Francisco in 2009, the Porsche is finished in Jager Grun - a typically 1970s olive green - and has had three owners in Sweden; it was purchased by *The Bridge*'s production company - Filmance International, its current owners - in October 2012. A desirable manual transmission model, restored at date unknown, the car comes with current Swedish registration papers, which list the names of previous owners in Sweden, as well as a letter of authenticity from the production company.

£20,000 - 30,000

€23,000 - 34,000

No Reserve



Proceeds of the sale will go to WaterAid, an international charity that works with local organisations to provide clean water and sanitation to some of the poorest parts of the world.

WaterAid is working to make clean water, decent toilets and good hygiene normal for everyone, everywhere within a generation. The international not-for-profit organisation works in 28 countries to change the lives of the poorest and most marginalised people. Since 1981, WaterAid has reached 25.8 million people with clean water and 25.1 million people with decent toilets.

302

Built to celebrate the wedding of Prince Harry and Meghan Markle

2018 MINI COOPER 'S' 3-DOOR HATCH

Registration no. YB18 HMH

Chassis no. TM82290

- Specially built by MINI
- Unique specification
- New and unused
- All sale proceeds to be donated to The Children's HIV Association (CHIVA)



This special Cooper S was built by MINI as a one-off to celebrate the recent royal wedding of Prince Harry and Meghan Markle, the sale proceeds of which will be donated to one of the couple's chosen charities: The Children's HIV Association (CHIVA).

'As an iconic British brand with almost 60 years of history, we are pleased to mark the royal wedding with this special charitable gift,' explained Oliver Heilmer, Head of MINI Design. 'The MINI Design team has created a one-off MINI Hatch for the occasion. Its specially designed roof graphic combine with 3D-printed interior and exterior details as well as special embroidery to make this a MINI like no other.'

Finished in Crystal White, this unique car features silver-blue accent strips, lending the body a distinctive look, while the black band that wraps around the car features a blue-tinted matt silver paint finish. Recognisable MINI design features in chrome, such as the frame for the hexagonal radiator grille, and the door handles and surrounds for the headlights and rear lights, are topped off with a blue-black tinted clear coat, bringing modernity and a freshness of detail to the MINI. Rear lights in Union Jack design and dark-blue matt metallic wheel rims put the finishing touches to its external appearance.

A particular highlight of the exterior is the roof's multi-coloured paintwork. The roof graphic is applied meticulously by hand in several layers and brings together elements of Prince Harry and Meghan Markle's national flags – the Union Jack and the Stars & Stripes. The special MINI's side scuttles around the side turn signal indicators have been 3D-printed. When the car is opened, they project an exclusive 'Just Married' welcome onto the ground in front of the driver's door and front-passenger door.

Satellite Grey leather has been chosen for the interior and provides the ideal backdrop against which to accentuate the MINI's bespoke elements. The blue-black tinted clear coat of the chrome exterior trim can also be found on selected chrome interior features. Another special feature of the interior is an accent inspired by the roof graphic, which is integrated into the trim strips in the doors, behind the steering wheel, and into the head restraints. On the latter, there is an abstract take on the Union Jack on one side and a Stars & Stripes perforation and stitching on the other. A wonderful opportunity to acquire this unique MINI, especially designed to celebrate the royal wedding, while at the same time contributing to a most worthy cause.

Please be advised that due to the limited number of kilometers recorded on the odometer, this Lot may incur a VAT liability upon registration in any EU country other than the UK.

£20,000 - 30,000

€23,000 - 34,000

No Reserve



'CHIVA is the voice of children and young people living with HIV in the UK and Ireland. CHIVA works to ensure that every child with HIV in the UK has optimum healthcare and social support to enable them to live well with HIV and achieve their greatest potential, to tackle HIV related stigma and discrimination, and raise awareness and understanding of HIV'

303

1969 TRIUMPH TR6 ROADSTER

Registration no. TAY 774H

Chassis no. CP269460

- *The ultimate TR sports car*
- *An older restoration*
- *Recent cylinder head overhaul*
- *MoT'd to May 2019*



'The use of a six-cylinder engine was not a new idea at all. Ever since the late-1950s there had been experimental TRs running around with six-cylinder engines, but for many years the sales organisation had shied away from the very idea; somehow they could not see a TR as a smooth and refined car. It was only the urgent need for more TR performance in the mid-1960s which caused their change of heart.' – Graham Robson, *'The Triumph TRs'*.

Its sports cars having relied exclusively on four-cylinder engines for the preceding decade-and-a-half, Triumph turned to six cylinders to extend the life and improve the performance of the much loved 'TR' series. Similar to the preceding four-cylinder TR4A - the first TR with independent rear suspension - but with Triumph's 2.5-litre, six-cylinder engine installed in place of the old 2.1-litre four, the TR5 was produced during the 1968 model year only (October 1967 to November 1968) pending the arrival of the TR6. Restyled for 1969 by Karmann of Osnabruck, the TR6 sported a full-width nose and squared-off tail.

Under the skin the chassis remained basically the same as its independently-rear-suspended TR4A ancestor's while the 2.5-litre Lucas fuel-injected power unit was unchanged, producing 150bhp initially then 124bhp from 1973 onwards. Handling was improved over that of the TR5 courtesy of wider wheels and a front anti-roll bar. Good for 120mph with acceleration to match, the six-cylinder TRs are arguably the most exciting Triumphs ever made, continuing to enjoy an enthusiastic following worldwide and an excellent network of spare parts and service providers.

The TR6 offered here is an older restoration believed to have been refurbished in Germany circa 1990. More recently, the car has benefited from a cylinder head overhaul, new fuel pump and filter, new fuel tank, and a rear brake overhaul. Accompanying documentation costs of a V5C Registration Certificate and MoT to May 2019.

£14,000 - 18,000
€16,000 - 21,000

304

1981 DELOREAN DMC12 COUPÉ

Registration no. WPC 246X

Chassis no. SCEDT26T4BD006424

- One of 9,200 built
- Delivered new in the USA
- First registered in the UK in April 1995
- Present ownership since March 2015



'Throughout the history of the British Motor Industry, hope and enthusiasm have tended to overrule commercial common sense. The DeLorean episode was perhaps its clearest example in Government.'
- Martin Adeney, *The Motor Makers*.

The brainchild of ex-General Motors executive John Zachary De Lorean, the DeLorean sports car project was touted around the world before finding a home in Northern Ireland thanks to generous grants from the British Government. Designed by ex-Pontiac engineer Bill Collins, the DMC12 was extensively reworked by Lotus prior to production, emerging with the latter's trademark steel backbone chassis and all-independent suspension, and powered by a rear-mounted Peugeot/Renault/Volvo 2.9-litre overhead-camshaft V6 engine. Apart from its larger-than-life creator, it was the car's stylish coupé body that attracted most attention by virtue of its method of construction - a combination of glassfibre inner panels and stainless-steel outer skin - and doors that opened gull-wing fashion à la Mercedes-Benz 300 SL.

The much-hyped DMC12 finally arrived in 1980 and immediately ran into quality control problems, a not altogether surprising occurrence considering the local workforce's unfamiliarity with automobile manufacture. No doubt the company would have sorted out the glitches given time, but sales never approached projected levels and De Lorean's 1982 indictment on drugs charges - he was subsequently acquitted - brought the project to its knees. By then some 9,200 DeLoreans had been built, of which approximately 6,500 survive today. They are now seen as highly collectible, thanks in no small part to the one that starred in the 1985 motion picture, *'Back to the Future'*.

This example was supplied new in the USA before being exported to Germany where it was purchased in 1995 by the immediately preceding owner. The current vendor purchased the car at a UK auction in March 2015, at which time it was said to have 'covered just 10,000 miles in the past 19 years' and to be 'in very respectable order'. Offered with a history file containing a V5C registration document, sundry service invoices, and a quantity of expired MoT test certificates, this instantly recognisable and highly collectible rarity is MoT'd to June 2019 and is described by the private vendor as in good condition throughout.

£25,000 - 30,000

€29,000 - 34,000

No Reserve

305

1964 ALFA ROMEO GIULIA 1600 SPIDER

Coachwork by Pininfarina

Registration no. to be advised

Chassis no. AR 383111

- *Classic Pininfarina styling*
- *Rare right-hand drive model*
- *Known ownership history*
- *Professionally restored in 2017*





Although the 1900 had been its first successful post-war model, it was Alfa Romeo's next offering, the 1.3-litre Giulietta, which established the 'small car, big performance' formula that would characterise the Milanese marque's finest offerings from then on. The Giulietta's arrival in 1954 caused a sensation; demand outstripped supply at first, causing Alfa to rethink its production strategy and become, for the first time, a high-volume manufacturer. The original Giulietta Sprint Coupé of 1954 was soon joined by Berlina and Spider versions. Sporting elegant coachwork designed and built by Pininfarina, the Giulietta Spider was a huge success and continued virtually unchanged in 1.6-litre Giulia guise when the latter joined the Alfa line-up in 1962.

A bonnet air scoop, necessary to clear the larger engine's taller block, readily identified the new model. The capacity increase boosted maximum power of Alfa's classic twin-cam four from 80 to 92bhp and the car's top speed to 109mph. Reliability was likewise enhanced and the larger engine was noticeably smoother and less fussy. A five-speed gearbox was standard on the Giulia 1600 Spider, which remained in production until replaced by the Duetto in 1966. Described by Cars Illustrated as 'probably one of the most delightful small sports cars which will ever be produced,' the Giulia Spider is certainly one of the most attractive Alfa Romeos of its day and remains highly regarded now.

This rare right-hand drive Giulia Spider had enjoyed three owners in the West Country, followed by a father and son, John and Rupert Gordon, both Alfa Romeo Owners Club members, before passing into the immediately preceding owner's hands in February 2002. The colour was changed from grey to blue during the Gordons' ownership. While in the preceding owner's care, the car was kept in original condition and maintained by the same mechanic (another AROC member) with all parts supplied by classic Alfa Romeo specialists, AlfaStop.

The current owner purchased the Alfa in June 2015, since when it has been treated to a 'last nut and bolt' restoration by DTR European Sports Cars of Coulsdon, Surrey (bills available). Completed in January 2017, the rebuild included repainting the car in grey.

The Giulia comes complete with its original hood, jack, spare wheel and tool kit, the latter containing a set of Lodge spark plugs. Described by the vendor as in 'A1' condition, this extremely fun, beautiful, and usable Italian sports car is offered with an old-style green logbook, sundry invoices, a V5C document and current MoT.

£48,000 - 55,000
€54,000 - 62,000

1920 ROLLS-ROYCE 40/50HP SILVER GHOST ALPINE EAGLE TOURER

Registration no. RR 7492

Chassis no. 10CW

- *Rare and desirable Alpine Eagle Speed Model*
- *Matching chassis and engine*
- *Exported to the USA in the early 1920s*
- *Professionally restored in the UK between 2008 and 2015*
- *Fewer than 3,000 miles since completion*



A rare and highly desirable Alpine Eagle Speed Model, this Silver Ghost, chassis number '10CW', was purchased in Wisconsin, USA in November 2007 by motoring author, Malcolm Tucker, who commenced its restoration in March of the following year.

Factory records show that '10CW' - confirmed as an Alpine Eagle Speed Model - came off test on 21st February 1920 and in April was invoiced to coachbuilders J B Ferguson of Belfast, Northern Ireland. Its first owner was a Mr J H McGugan of Belfast, and there are two further owners listed on the chassis cards. Chassis cards also show that this car's gearbox and that of '21FW' were swapped, and confirm that '10CW' retains its original engine, 'J171'. It is not known for certain when the Silver Ghost was exported to the USA, though an entry on the chassis cards suggests August 1922.

Records held by the R-ROC Foundation show that '10CW' once belonged to one L I Dimm, who in 1932 sold the car to Mr Al Gross of Long Island. Some five other owners are recorded. While in the USA, '10CW' carried a sedan-limousine body by coachbuilders Brooks-Ostruk of West 66th Street, New York City. Brooks-Ostruk was part of Rolls-Royce of America's 'Custom Coachworks' initiative, whereby its standard bodies were built by a number of the USA's most prominent coachbuilders, though a Rolls-Royce customer to could still take delivery of his or her car in bare chassis form for bespoke bodying.



By the time Malcom Tucker bought the Rolls-Royce, it had been off the road in an open-fronted barn for over 40 years. The Brooks-Ostruk body had deteriorated badly, but fortunately the chassis and mechanical components had survived in much better condition and were around 95% complete. Restoration of the mechanicals was entrusted to Mike Knowles, proprietor of Ro-Ben Cars of South Stoke, Surrey. Inspection revealed that the Brooks-Ostruk body had not been made for a Silver Ghost, and it was decided that an open touring body, as close to the Ferguson original as possible, would be more appropriate.

Once a substantial portion of the mechanical overhaul had been completed, the refurbished rolling chassis was despatched to the coachbuilder while work continued on the engine, clutch, and gearbox. Western Coachworks of Mickleover, near Derby was chosen to make the new body, which was constructed to Malcolm Tucker's own Ferguson-inspired design using Rolls-Royce's instructional booklet for coachbuilders. With the body tub completed by the end of July 2012, the Silver Ghost was returned to Ro-Ben for the engine to be reinstalled.

Unforeseen circumstances (Mike Knowles being unwell) meant that the mechanical restoration had to be completed elsewhere, and the task was assigned to Allan Glew. Trevor Hirst of Christchurch fabricated a new set of wings and new bonnet sides, the original bonnet being retained.

By July 2015, '10CW' was ready for a registration application to be made to the DVLA, and after a seemingly endless succession of bureaucratic obstacles had been overcome, the car eventually received the highly appropriate registration, 'RR 7492', in March 2016. Later that same year, the Silver Ghost was acquired by the current vendor, who advises us that fewer than 3,000 miles have been covered since the restoration's completion.

Beautifully proportioned, the Silver Ghost is finished in grey with contrasting red hide buttoned seats to the interior, while the convertible hood is of black double duck and folds down into a matching hood bag. There is a useful luggage rack at the rear, and a pair of tonneau covers comes with the car. The dashboard is beautifully made from a single piece of American cherry wood, as are the door cappings, while twin cherry wood boxes of cabinet-maker's quality are mounted on the running boards. The original under-trays are in situ, and a nickel-plated klaxon horn is mounted on the bulkhead.

Malcolm Tucker's fascinating account of the history and resurrection of '10CW' is available in the form of two (copy) magazine articles on file, and the car also comes with invoices issued by the various specialists involved totalling circa £231,400. This fine sporting Rolls-Royce Silver Ghost remains in beautiful condition, wants for nothing, and is ready to be enjoyed.

£150,000 - 180,000
€170,000 - 210,000
No Reserve

1973 FERRARI DINO 246 GTS

Coachwork by Pininfarina/Scaglietti

Registration no. TGC 66L

Chassis no. 05864

- *Iconic V6-engined Dino*
- *One of the final ('E') series*
- *Matching numbers*
- *Last owner since 2005*
- *Maintained with no expense spared*
- *Recent engine and gearbox rebuilds*

'It is a thrill to drive a car like the Dino, one whose capabilities are far beyond what even an expert driver can use in most real-world motoring, and that is the Dino's reason for being. The real joy of a good mid-engined car is in its handling and braking and the Dino shone as we expected it to. The steering is quick without being super quick, and it transmits by what seems a carefully planned amount of feedback exactly what is going on at the tyres. Thanks to the layout's low polar moment of inertia the car responds instantly to it. The Dino's cornering limits are very high...' – *Road & Track*.

It was the need for a production-based engine for the new Formula 2 that had prompted the introduction of a 'junior' Ferrari, the Dino 206 GT, at the Turin Motor Show in 1967. The latest in a line of Dino V6 'quad-cam' engines stretching back to the late 1950s, the new unit proved as successful on the racetrack as in the showroom, Derek Bell and Ernesto Brambilla both winning races in the European Championship, while Andrea de Adamich triumphed in the 1968 Argentine Temporada series.

Building on experience gained with its successful limited edition Dino 206S sports-racer of 1966, Ferrari retained the racer's mid-engined layout for the road car but installed the power unit transversely rather than longitudinally.

A compact, aluminium-bodied coupé of striking appearance, the Pininfarina-styled Dino - named after Enzo Ferrari's late son Alfredo Ferrari and intended as the first of a separate but related marque - was powered by a 2.0-litre, four-cam V6 driving via an in-unit five-speed transaxle. The motor's 180 brake horsepower was good enough to propel the lightweight, aerodynamically-efficient Dino to 142mph, and while there were few complaints about the car's performance, the high cost enforced by its aluminium construction hindered sales.





A 2.4-litre version on a longer wheelbase - the 246 GT - replaced the original Dino 206 in late 1969. Built by Scaglietti, the body was now steel and the cylinder block cast-iron rather than aluminium, but the bigger engine's increased power - 195bhp at 7,600rpm - adequately compensated for the weight gain. A Targa-top version, the 246 GTS, followed in 1972. The Dino 246 was built in three series: 'L', 'M' and 'E', these designations reflecting detail changes in the specification. Of the three, the M-series is by far the rarest, being produced during the early months of 1971 only. Changes from the preceding L-series included a 30mm increase in rear track; five-bolt fixing for the road wheels; internal boot release; seat-mounted headrests; and various minor improvements to the engine and gearbox. The final 'E' series incorporated all the changes made to its predecessors together with further improvements to the engine and gearbox and numerous other more minor details.

While not quite as fast in a straight line as its larger V12-engined stablemates, the nimble Dino was capable of showing almost anything a clean pair of heels over twisty going. Truly a driver's car par excellence and still highly regarded today.

One of the final 'E-series' cars, the Dino 246 GTS offered here is an original right-hand drive matching-numbers example built for the UK market and delivered via Maranello Concessionaires. '05864' was originally finished in Blu Dino Metallizzato with beige leather interior, and came equipped with the standard Cromodora alloy wheels. The first owner was Charles Barker & Sons Ltd, London. The Dino went on to enjoy four further owners before passing into the last (sixth) owner's hands in 2005 (details of all owners available).

We are advised that a complete body restoration was carried out in 1991 (bills available), and that during the last ownership some £65,000 was spent in keeping the car in top condition. Works carried out by specialists within the last three years include rebuilds of the engine and gearbox. Described by the vendor as in generally very good condition, driving and performing superbly, this beautiful Dino is offered with an old-style logbook, V5C Registration Certificate, MoT to June 2019, and a Massini Report.

£250,000 - 300,000
€290,000 - 340,000

308 N

The ex-Henry du Pont

1928 BUGATTI TYPE 44 TOURER

Coachwork by Harrington

Chassis no. 44721

Engine no. 435

- *Delivered new to the UK*
- *Matching numbers*
- *First owned by Henry B du Pont*
- *Known ownership history*
- *Outstandingly original*
- *Well known in Bugatti circles*





'Bugattis encapsulate concepts of engineering which, once seen, change your ideas radically and definitively. Drive them, and you realise that each car is form and engineering in equilibrium, and a work of art.'
– William Stobbs, *Les Grandes Routières*.

By the early 1930s Ettore Bugatti had established an unrivalled reputation for building cars with outstanding performance on road or track; the world's greatest racing drivers enjoying countless successes aboard the Molsheim factory's products and often choosing them for their everyday transport. Considered the finest touring Bugatti of the 1920s, the Type 44 was introduced towards the end of 1927 and lasted in production until 1930. 1,095 were built, of which around 10 percent survive today. The model was powered by Bugatti's classic single-overhead-cam straight eight engine, one of the most famous automobile power units of all time. Because of its lengthy run of success, Ettore Bugatti remained committed to his single-cam design, only adopting the double-overhead-camshaft method of valve actuation, after much prompting by his eldest son Jean, on the Type 50 of 1930.

The Type 44's twin-block, three-valves-per-cylinder, single-plug engine displaced 2,991cc and produced approximately 80bhp, an output good enough for a top speed of over 75mph. Driving via a four-speed gate-change gearbox, this superb power-plant was housed in Bugatti's familiar vintage chassis featuring a circular-section front axle and rear quarter elliptic springing.

This Type 44, chassis number '44721' fitted with engine number '435', was originally ordered by London-based Bugatti agent, Colonel Sorel. It is one of just 12 Bugattis of various types ordered by the Colonel in October 1928, and was delivered on 15 November that same year. The car was delivered to London in rolling chassis form and was then despatched for bodying to coachbuilder Thomas Harrington Ltd, at that time based in Brighton, Sussex. Founded in 1897 and known to have been bodying cars as early as 1905, Harrington had become a major producer of motor coach bodies while keeping up the car-bodying side of its business, concentrating on high-quality European makes, Bugatti included.



Like many of Harrington's car bodies, this Type 44's four-door tourer was constructed using the Weymann system. This type of body construction took its name from its inventor - Charles Terres Weymann - a Frenchman whose background in aviation led to him using a lightweight wooden framework for motor bodies, which was held together by steel plates and covered with fabric. The principal advantage of the Weymann system was its inherent flexibility, which meant that it was free of the squeaks, creaks, rattles and cracks that hitherto had affected all traditional coachbuilt bodies. It was an immediate success; as well as making bodies at its factories in France and (later) England, Weymann licensed production to numerous independent coachbuilders, Harrington among them. Research indicates that Harrington produced two variants on this Tourer theme; one where the spare is on the wing, the other - such as this example - where the wheel is rear mounted and therefore aesthetically more desirable.

Originally finished in black, with red wire wheels, brown leather interior, and tan soft-top, '44721' was purchased new in England by an American, Mr Henry B du Pont of Delaware, a member of the eponymous chemicals manufacturing dynasty. Twenty-nine years old when he purchased the Bugatti, he later became a vice president of the DuPont company while at the same time serving as a board member of General Motors. Mr du Pont used the Bugatti for a honeymoon trip around Europe with his new wife, Margaret Wilson Lewis. The car's UK registration was 'UF 3321'.

Remarkably, Henry du Pont kept his Bugatti from some 34 years, surely a mark of the fond memories he had of the Type 44, only parting with the car to a family member in 1962, selling to his relative, a Mr John Riegel of Montchamin, Delaware. Within a year, the Bugatti had passed to yet another member of the family, Richard Riegel, and later in the mid-1960s was offered for sale by The Vintage Car Store, New York. In 1969, Mr Nelson Deedle bought the car, which in 1973 found a new home with one F E Davis.

Offered for sale at a London auction in July 1975, the Bugatti was purchased on one R Bell, while its next owner, from 1976, was The Honourable G H Wilson of Newton Valance, Hampshire. Wilson later sold '44721' to Graham Little, author of an unpublished 'Who's Who' of Bugatti people, and in 1985 the car changed hands yet again, passing to Geoffrey Perfect. Offered for sale at an auction in Birmingham in 1990, the Bugatti was purchased by well-known collector Peter Groh, who in turn sold it to respected Dutch dealer, Jaap Braam Ruben. Offered for sale by Braam Ruben at a Paris auction in June 1991, the Type 44 was purchased by Jean Paul Mouton, who registered it in France as '853 KAH 75'.



Mr Mouton owned the Bugatti for the next 24 years, displaying it at the Centre Internationale de l'Automobile in Pantin, Paris between December 1992 and March 1993, and taking part in several events including the Bugatti-Ferrari meeting in Beaune in 2004 and also a Louis Vuitton backed rally in China. More recently, in 2016, the Type 44 was exhibited to much admiration at the prestigious Zoute Grand Prix concours in Belgium.

Throughout all this time and these many changes of owner, this Type 44 has remained outstandingly original, the only significant change in specification being the replacement of the body's original fabric covering with a more durable modern material. Well-known in Bugatti circles, '44721' is listed in four Bugatti Registers (two by Hugh Conway and two by David Sewell) as well as in Barrie Price's book, *'The 8-Cylinder Touring Cars'*.

Offered with French registration papers, '44721' represents a wonderful opportunity to acquire an outstandingly original and well sorted Type 44, eligible for many of the world's most prestigious historic motoring events.

£320,000 - 400,000

€370,000 - 460,000

No Reserve



1962 ALFA ROMEO GIULIA SPRINT COUPÉ

Registration no. NTJ 613M

Chassis no. 354261

- Classic 1st Generation Giulia Sprint
- Imported from the USA
- Left-hand drive
- Present family ownership since 1974
- Restored between 2005 and 2010
- Fewer than 500 miles since restoration



'One of Satta's very remarkable achievements was the creation of a race of modern, mass-produced motor cars which, depending on the model, retain or improve upon the competition-bred thoroughbred qualities of Alfa Romeos of the artisan past.' - Griffith Borgeson, *'Alfa Immagini e Percorsi'*, 1985.

By the time of the Giulia's introduction in 1962, Alfa Romeo's highly successful 'small car, big performance' formula, begun by the Giulietta in 1954, was well established. The Giulia is one of Alfa Romeo's many imaginative and successful designs produced under the aegis of Dr Orazio Satta Puglia, the company's esteemed Central Director. It was Satta who brought high-volume production to Alfa Romeo with the Giulietta, thereby ensuring the company's future.

Alfa's classic twin-cam four was downsized to 1,290cc for the Series 750 Giulietta, gaining an alloy cylinder block in the process. The debutante Sprint Coupé was soon joined by Berlina and Spider versions, and then in 1959 came the ultimate Giulietta - the Sprint Speciale.

These model designations and body styles were carried over into the improved 101 Series Giuliettas produced from 1959 and continued when the range was up-graded to Giulia status in 1962. Outwardly almost indistinguishable from the outgoing Giulietta, the Series 101 Giulia boasted a more powerful and much less fussy 1,570cc engine, in addition to welcome improvements to the previously feeble heating arrangements. 'Few cars can rival the 1600 Alfa for sheer driving enjoyment, and the keen driver devoting his full attention to driving it will be amply rewarded,' declared *Car & Driver*.

Finished in rosso with black interior, this left-hand drive Giulia Sprint was imported from the USA by an American student and sold to the vendor's father in 1974 (at 43,000 miles). Inherited by the vendor in 2004, the Alfa was restored between 2005 and 2010 at a cost of over £47,000 (bills on file), since when it has been kept in dry storage and MoT'd every year. Fewer than 500 miles have been covered since the restoration's completion, the current odometer reading being circa 52,700. Accompanying documentation consists of a current MoT certificate, V5C registration document, and the aforementioned bills.

£30,000 - 40,000
€34,000 - 46,000

By the order of the executors

THE COLLECTION OF THE LATE PAUL JENNINGS



310

1985 LAND ROVER 90 V8

Registration no. C625 HHK

Chassis no. SALLDVAV7AA241787

- Collectible first-of-the-line model
- Two owners from new
- Present ownership since 1995
- Some service history



Inspired by the US Army's wartime 'Jeep', developed in haste and intended for short-term small-scale production, the Land Rover would defy its creators' initial scepticism. Rover bosses the Wilks brothers saw the need for a tough, four-wheel-drive, utility vehicle to serve the needs of the agricultural community in the immediate post-war years, but the Land Rover's runaway success took the company by surprise. The necessity of using corrosion resistant aluminium panels at a time of severe steel shortage turned into a positive virtue in the Land Rover's sphere of operations, while the use of existing components kept production costs down and cut development time. In the course of more than 60 years in production the supremely versatile Land Rover would prove itself adaptable to innumerable civilian and military roles.

Following the launch of the extensively revamped Land Rover 110 in 1983, a similar short-wheelbase version was added to the line-up the following year.

Nominally of 90" wheelbase (actually 92.9") the newcomer incorporated all the improvements pioneered on the 'One-Ten', including coil-sprung suspension, one-piece windscreen, five-speed gearboxes and a revised interior, while adding a refinement of its own - wind-up windows - that subsequently featured on the larger model. Engine options were a 2.25-litre petrol four, 2.5-litre diesel four, and the 3.5-litre petrol V8. The latter endowed the 90 with decent performance by Land Rover standards, *Motor* magazine recording a 0-60mph time of 14.7 seconds and a top speed of 90mph; it was just what the emerging off-road leisure market wanted.

First registered on 30th September 1985, this 90 V8 was acquired by the late Paul Jennings in July 1995. The vehicle has had one former keeper, who purchased it new. Accompanying documentation consists of a V5C Registration Certificate; various invoices for servicing, etc; a quantity of expired MoTs; and a replacement service book recording services in 2007, 2009, and 2011.

£3,500 - 5,000

€4,000 - 5,700

No Reserve

311

1972 RANGE ROVER 4X4 ESTATE

Registration no. BMR 745L

Chassis no. 355-05144A

- Landmark 4x4 design
- Early 'Suffix A' model
- Increasingly sought after
- The one for the connoisseur



'The first production Range Rover seemed a technological wonder. Permanent four wheel drive, dual line disc brakes, and lightweight V8 engines were unusual enough on road cars; thoroughly radical for anything that went off road.' – Eric Dymock, *'Land Rover File'*.

An outstanding landmark design that almost single-handedly created the booming market in dual-purpose 4x4s, the Range Rover was greeted with universal acclaim on its arrival in 1970 and has remained the class leader, despite ever increasing foreign and domestic competition, ever since. The idea of a more road-biased 4x4 had been around since the Land Rover's arrival in the late 1940s, but it would be some two decades before the concept crystallised in what would end up as the Range Rover. Spen King and Gordon Bashford were responsible for the initial conception, with final detailing entrusted to David Bache.

A separate, Land Rover type chassis was employed to carry the enclosed aluminium body, while long-travel coil-sprung suspension ensured that the ride would be more saloon car than utility. Rover already possessed an ideal power unit in the form of its 3.5-litre light alloy V8.

The Range Rover was greeted enthusiastically by both press and public on its arrival in 1970, offering comfortable cruising at 90mph and a greater off-road capability than most of its customers would ever need. The fact that the original lasted in production for an amazing 24 years before being replaced in 1994 only serves to illustrate the soundness of the original concept. Indeed, the 'old' Range Rover - evocatively renamed 'Range Rover Classic' - did not disappear immediately but continued to be built for another year alongside the new version.

This desirable 'Suffix A' model was originally finished in Tuscan Blue and sold new in October 1972 to Colletts Avon Motors Limited of Salisbury, Wiltshire. The late Paul Jennings acquired the vehicle from the Land Rover Centre, Huddersfield in March 2015. Representing a rare opportunity to acquire a fine example of the iconic Range Rover in its earliest and purest form, the car is offered with sundry invoices, a BMIHT Certificate, V5C registration document, and service booklet last stamped in January 1998.

£26,000 - 34,000

€30,000 - 39,000

No Reserve

312

**1964 ASTON MARTIN DB5
4.3-LITRE SPORTS SALOON**

Registration no. FPF 38B

Chassis no. DB5/1758/R

- *Owned and maintained by the Forshaw family (Aston Service Dorset) for 36 years*
- *Repainted by Aston Martin Works Service*
- *Bill Goodall-built engine*
- *ZF five-speed gearbox*
- *The most famous of all 'James Bond' Aston Martins*





'Like all classic GT cars, it combines enormous speed and comfort and the more you put into your driving, the more the car returns for your entertainment. And the DB5 really is entertaining to anyone who can exploit its outstanding performance, handling and brakes. It will also carry four people (just) and a fair amount of luggage so the merits of family transport (if need be) have not entirely been sacrificed to speed and elegant looks.' – *Motor*, 6th February 1963.

Aston Martin's post-war evolution took a giant step forward with the launch of the DB4 in 1958. Classically proportioned, the Touring-designed body established an instantly recognisable look that would stand the marque in good stead until 1970. The engine was still an all-alloy, twin-overhead-camshaft, six but the old W O Bentley supervised 3.0-litre unit had been superseded by a new design by Tadek Marek. The new 3,670cc engine featured 'square' bore and stroke dimensions of 92mm, and developed its maximum power of 240bhp at 5,500rpm. The David Brown gearbox was a new four-speed all-synchromesh unit.

Touring's Superleggera body construction, which employed a lightweight tubular structure to support the aluminium-alloy body panels, was deemed incompatible with the DB2/4-type multi-tubular spaceframe, so engineer Harold Beach drew up an immensely strong platform type chassis. The DB2/4's trailing-link independent front suspension gave way to unequal-length wishbones while at the rear the DB4 sported a live axle located by a Watts linkage instead of its predecessor's Panhard rod.

Five series were built as the model gradually metamorphosed into the DB5. Introduced in July 1963, the Aston Martin DB5 boasted a 4.0-litre engine, this enlarged unit having been seen first in the Lagonda Rapide of 1961. Equipped with three SU carburetors, the '400' engine produced 282bhp at 5,500rpm and was mated to a four-speed/overdrive gearbox, a 'proper' ZF five-speed unit being standardised later.

The DB5's distinctive cowl headlamps had first appeared on the DB4GT and the newcomer was the same size as the lengthened, Series V DB4. Outwardly there was little to distinguish the DB5 from the last of the DB4s apart from twin fuel filler caps, though these had already appeared on some cars. Beneath the skin however, there were numerous improvements including alternator electrics, Girling disc brakes instead of Dunlops, Sundym glass, electric windows and an oil pressure gauge as standard equipment.

From September 1964 the 314bhp, triple-Weber Vantage engine became available and was fitted to a total of 95 cars. The DB5 was also offered in convertible form (the 'Volante' name would not be applied to the soft-top Aston until the DB6's arrival) while independent coachbuilder Harold Radford offered a shooting brake conversion. 1,021 DB5s were manufactured between July 1963 and September 1965, a total that included 123 convertibles and 12 shooting brakes.



The DB5 was the first and remains the most famous of all the 'James Bond' Aston Martins, having appeared in no fewer than five movies of the series, beginning with Goldfinger in 1964. Equipped with rocket launchers and sundry other gadgets, 007's DB5 was finished in Silver Birch with red interior, in which specification it was later issued by Corgi Toys.

Its accompanying (copy) guarantee form reveals that '1758/R' was manufactured on 10th November 1964 and retailed via HWM to its first owner, a Mr Longhurst of Walton-on-Thames, Surrey. Its original colour scheme was Caribbean Pearl with dark blue interior trim. The second owner is recorded as one R C Davey of Camberley, Surrey. Aston Service Dorset maintained the car for Mr Davey and bought it from him in 1980. One of the marque's most respected specialists, Aston Service Dorset had been founded by Captain Ivan Forshaw, and the DB5 remained in the Forshaw family's possession following his death in 2006. It left the Forshaw family in 2016, passing to the late Paul Jennings in February of that year; as such, it represented a very sound purchase having been maintained by one of the best in the business for some 36 years.

Aston Service Dorset has always enjoyed close connections with the factory, and when Aston Martin set up a new paint facility at its Works Service department at Newport Pagnell in the early 1990s, they asked ASD if it could supply a car for repainting to demonstrate the quality of finish that customers could expect. ASD supplied this DB5 which, consequently, received a world class re-spray that still presents superbly.

Aston Service Dorset fully serviced the DB5 prior to its sale in 2016, at which time the radiator was re-cored, new Perspex headlight covers fitted, and some minor under-seal imperfections addressed. The following year, in December 2017, Paul Jennings had a replacement engine built up around a new Aston Martin-supplied cylinder block by renowned marque specialist Bill Goodall of Newlands Motors (see bill on file for £18,815). The removed engine (not the car's original) is included in the sale (Lot 324).

Presented in beautiful condition and 'on the button', driving superbly, this lovingly cherished and fastidiously maintained DB5 is offered with tool roll, instruction book, parts catalogue and workshop manual (reprints), MoT to January 2019, and a V5C Registration Certificate.

Aston Martin's association with the James Bond movie franchise commenced with the DB5, which has enjoyed an exalted status and continuing high demand ever since. Exceptional examples such as this one are rarely offered for sale, and '1758/R' - never restored, highly original, and benefiting from long-term ownership by one of the most respected Aston Martin specialists - is worthy of the closest inspection.
£440,000 - 520,000
€500,000 - 590,000

313
NO LOT



314

1967 ASTON MARTIN DB6 4.5-LITRE SPORTS SALOON TO VANTAGE SPECIFICATION

Registration no. ABW 220E
Chassis no. DB6/3044/R

- Original logbook and warranty
- Previously Bill Goodall's personal car
- Bill Goodall-built engine
- Present ownership since January 2016



'I have driven most of the Aston Martin models that have been produced, from the racing twin-cam 1½-litre of the 1920s onwards. For years my favourite has been the DB3S sports-racer, but now my allegiance is wavering. There can be little doubt that the DB6 is the best Aston yet and it is a credit to British engineering.' - John Bolster on the DB6 Vantage, *Autosport*, 21st October 1966.

The culmination of Aston Martin's long-running line of 'DB' six-cylinder sports saloons and thus considered by many to be the last 'real' Aston, the DB6 was introduced in 1965, updating the DB5. Although recognisably related to the Touring-styled DB4 of 1958, the DB6 abandoned the Superleggera body structure of its predecessors in favour of a conventional steel fabrication while retaining the aluminium outer panels. Increased rear-seat space was the prime DB6 objective so the wheelbase was now 4" longer than before, resulting in an extensive restyle with more-raked windscreen, raised roofline and reshaped rear quarter windows. Opening front quarter lights made a reappearance but the major change was at the rear where a Kamm-style tail with spoiler improved the aerodynamics, greatly enhancing stability at high speeds. These many dimensional changes were integrated most successfully, the DB6's overall length increasing by only 2". Indeed, but for the distinctive Kamm tail one might easily mistake it for a DB5.



The Tadek Marek-designed six-cylinder engine had been enlarged to 3,995cc for the preceding DB5 and remained unchanged. Power output on triple SU carburetors was 282bhp, rising to 325bhp in Vantage specification. Borg-Warner automatic transmission was offered alongside the standard ZF five-speed gearbox, and for the first time there was optional power-assisted steering.

First registered on 20th March 1967, this DB6 comes with its original warranty showing that the first owner was one Royden Meyer. The original logbook records Mr Meyer's address as Chigwell, Essex, and the original colour as white. Mr Meyer kept the Aston for almost five years, the first change of keeper being recorded as January 1972 when it passed to Stile Educational Company of Oxford.

In May 1975, the DB6 was acquired by Mr Christopher Walpole of Banbury, who in May 1976 took the original registration 'NYP 350E' off the car, reregistering it as '69 CNW'. Mr Walpole kept the Aston for some 35 years before selling it in 2010 to one Andrew Dooley of Hawkhurst, Kent. It was at this time that the car first acquired its current registration, 'ABW 220E'.

Shortly thereafter, in October 2011, '3044/R' was acquired by the highly respected Sussex-based marque specialist, Bill Goodall (Newlands Motors) as his personal car, carrying the registration '1 DBV'. Bill rebuilt the engine to Vantage specification and 4.5-litres capacity around the original cylinder block (reconditioned by R S Williams); as one would expect, this DB6 reportedly goes very well! He also changed the exterior colour from white to the current Black Pearl. Faced with upcoming expenses, Bill regretfully sold '3044/R' to the late Paul Jennings in January 2016, the DB6 reverting to its previous registration, 'ABW 220E'.

The substantial history file contains the car's aforementioned logbook and warranty; 17 expired MoTs for the period 1975 to 2016; assorted pieces of correspondence; and numerous invoices from recognised specialists detailing servicing and maintenance dating from the present day back to the 1970s.

£180,000 - 240,000
€210,000 - 270,000

315

1967 SUNBEAM ALPINE SERIES V ROADSTER

Registration no. PAB 692E

Chassis no. 395015513GT0DHRC

- Final version of the Alpine
- Present ownership since October 2016
- Last MoT expired March 2017



'The original Alpine, of 1953 to 1955, had not sold as well as the Rootes family had hoped, but the second attempt was much more successful. This time the car was not to be lumbered with an old-fashioned chassis; it would have ultra-modern style...' – Graham Robson, *'Cars of the Rootes Group'*.

Aimed at the North American market, where British sports cars were enjoying considerable success, the Sunbeam Alpine was produced in five series between 1959 and 1968. Built on the Hillman Husky II floor pan, the Alpine employed Sunbeam Rapier running gear and the same 1.5-litre, overhead-valve, four-cylinder engine found in many of Rootes' other products. In Alpine form the unit boasted an alloy cylinder head and twin carburettors, producing 78bhp, an output good enough for a maximum speed of almost 100mph. The Alpine was progressively improved through Series II-V, gaining an all-synchromesh gearbox in 1964 on the Series IV and a 1,725cc, five-bearing engine in 1965 on the Series V, which also marked the arrival of alternator electrics and an oil cooler, unusual standard features at that time.

As a competition car, the Alpine is mainly remembered for some sterling performances at Le Mans where it won the Index of Thermal Efficiency in 1961. In rallying though, the Alpine found itself pitted against the larger engine and more powerful Triumph TR3As and Austin-Healey 3000s. Leader-board finishes were hard to come by, although Rosemary Smith's Coupe des Dames in the 1963 Tour de France was a notable result.

This Series V Alpine was purchased by the late Paul Jennings in October 2016 (receipt on file). Accompanying copies of V5 documents and a photocopied continuation logbook contain details of previous owners dating back to 1972, while also on file are sundry invoices dating back to 1985 and a quantity of MoT certificates, the most recent of which expired in March 2017. A workshop manual is included in the sale.

£7,000 - 10,000

£8,000 - 11,000

No Reserve

316

1972 TVR VIXEN S3 COUPÉ

Registration no. AMB 734K

Chassis no. 19424

- *Classic early TVR*
- *Ford Capri GT engine*
- *One of 168 Vixen S3s made*
- *Present ownership since December 1989*



Founded in Blackpool in the late 1940s by Trevor Wilkinson, TVR began by making various 'specials' before introducing its first series production model – the TVR Sports Saloon – in 1954, most of which were sold in kit form. The car that really put TVR on the map though, was the Grantura. Launched in 1958, the Grantura used a multi-tubular spaceframe chassis with Volkswagen trailing-link independent suspension all round, which was clothed in very pretty glassfibre coachwork that set the pattern for TVRs for years to come. The generously proportioned engine bay could accommodate a wide variety of engines, those of Ford and BMC being the most popular, while Grantura owners intending to go racing, as many of them did, usually specified the 1.2-litre overhead-camshaft Coventry Climax FWE unit.

Very little differentiated the Grantura Mark II from its predecessor, while the introduction in 1961 of the Mark IIA brought with it the welcome adoption of front disc brakes. The bodyshell remained essentially the same, and remained so even after the introduction of an entirely new and vastly improved chassis on the Mark III of 1962. Designed by TVR's Technical Director, John Thurner, this new and longer frame featured double-wishbone suspension all-round, and would stand the company in good stead for the next 10 years.

TVR's famous sawn-off 'Manx' tail, with its distinctive Ford Cortina Mark 1 rear lights, first made its appearance in 1964 on the Ford V8-engined Griffith, and in the interests of standardisation was adopted on a new four-cylinder model: the MGB-powered Grantura 1800S. It was the latter, fitted with the 1.6-litre Ford Cortina GT engine, that in 1967 became the Vixen S1. Introduced in October 1968, the longer wheelbase of the S2 made it possible to lengthen the doors, improving accessibility, while there were numerous other changes and improvements. Built from October 1970 to April 1972, during which period 168 were made, the Vixen S3 benefited from the more powerful Ford Capri 1600 GT engine and its associated all-synchromesh gearbox.

This Vixen S3 was purchased in December 1989 from David Gerald TVR Sportscars Ltd having previously belonged to a Mr Gaskin from Cambridge, its owner since September 1987. Accompanying documentation consists of sundry invoices, a V5 registration document, and expired MoTs for the period 1984 to 1994 plus sundry newer ones.
£10,000 - 15,000
€11,000 - 17,000
No Reserve

317

1964 FERRARI 330 GT 2+2 'SERIES I' COUPÉ

Registration no. CBU 554B

Chassis no. 5839GT

- One of only 36 right-hand drive cars built
- Delivered new in the UK
- Comprehensive history file
- Extensively restored by Joe Macari in 2014



Introduced in January 1964, the 330 GT 2+2 was based on the preceding 250 GTE 2+2, Ferrari's first four-seater road car. Pininfarina was once again entrusted with the styling, adopting a four-headlamp frontal treatment that reflected the tastes of Ferrari's most important export market, the USA. The 'Series 1' 330 GT has become truly evocative of 1960s fashion, lauded both for its individuality and Pininfarina's purity of design.

Like its predecessor, the 330 GT employed a tubular chassis; the newcomer's though, was 50mm longer in the wheelbase, which made conditions less cramped for the rear passengers. Suspension was independent at the front by wishbones and coil springs while at the back there was a live axle/semi-elliptic set-up. Improvements to the discs-all-round braking system saw separate hydraulic circuits adopted front and rear.

The 330's Colombo-type, 60-degree, V12 engine had first appeared in the 330 America (effectively a re-engined 250 GTE 2+2) in 1963. Displacing 3,967cc, the two-cam all-alloy unit was good for 300-plus horsepower at 6,600rpm, an output sufficient to propel the 330 GT to a maximum velocity of 152mph (245km/h) making it, when introduced, the fastest road-going Ferrari.

Equipped at first with a four-speeds-plus-overdrive gearbox, the 330 GT gained a five-speed transmission in mid-1965 and later that year had its four-headlight front end replaced by a two-lamp arrangement, these later cars being known as the 'Series 2'. By the time production ceased in 1967, Ferrari had built 1,080 330 GTs, the split being 625/455 Series I/Series 2. Built alongside the ultra-exclusive Superamerica models, the 330 GT was Ferrari's ultimate grand tourer for the sophisticated client during the era known in Europe as 'La Dolce Vita'. A favourite of Enzo Ferrari, it was the first of his cars to sell in excess of 1,000 units.

A Series I model, '5839GT' comes with a most substantial and well organised history file containing the original Service Handbook and original Spare Parts Catalogue, the latter's cover annotated with hand-written notes of services with dates and mileage. There is also a collection of fascinating correspondence between the UK Ferrari importer, Maranello Concessionaires, and the car's original owner, Oscar Swan, Chairman of the Hydraulic Engineering Company Limited, Chester. These letters document the entire purchasing process: from Maranello's proprietor, Colonel Ronnie Hoare, organising a demonstration drive, to Mr Swan boarding the plane to Milan to collect his new Ferrari. Mr Swan had traded in his 1957 Bentley Continental Flying Spur, handing it over at the airport, and received a £65 allowance for collecting his Ferrari rather than having it delivered to the UK.



The car was first registered 'OS 800' and then 'KXH 504B' following its sale by Mr Swan. The next owner recorded in the history file is Multi Track Limited of Southampton, as evidenced by invoices from Maranello Concessionaires dated 1971. Further Maranello invoices from the 1970s note other changes of ownership: to one P Bailey of Avenue Car Sales, Beaulieu followed by one William T Clegg of Boldre near Lymington, who reregistered the car as '888 WTC'.

Towards the decade's end the Ferrari was exported to the USA and by 1978 was in the care of Jack Bartz of Bartz Manufacturing, Santa Barbara, California. There is a letter on file from him to a UK-based classic car dealer together with various service invoices, while a number of sequential insurance certificates show that the Ferrari was owned from 1983 until at least 1992 by Thomas and Karyn Hutchinson of Whittier, California.

The next known owner is one Benjamin Galdston of Del Mar, California, who kept the Ferrari from 2005 to 2012, entering it in the Concours Competition at the Julian Classic Motoring Society's Car Show of May 2006. The Concours entry certificate is on file together with various maintenance invoices accumulated during his ownership.

Repatriated to the UK by Hexagon Classics, the Ferrari was extensively re-commissioned for them in 2014 by marque specialist Joe Macari at a cost approaching £74,000 (invoices on file). Works carried out included overhauling the suspension and brakes, replacing the exhaust system, servicing the engine, rebuilding the gearbox, overhauling the alternator, etc.

Offered for sale by Hexagon, '5839GT' was purchased by the late Paul Jennings in April 2015. Since then, Wildae Restorations has carried out further works including overhauling the carburettors and ignition system; replacing the radiator with a 20mm thicker alloy unit; fitting a new electric cooling fan; and replacing the clutch.

The car comes with a photocopied handbook, original workshop manual, and original technical information - all bound in a lever-arch file - plus an original handbook and spare parts catalogue, while the comprehensive history file contains everything back to a copy of the original Certificato d'Origine of 1964. Presented in beautiful condition, '5839GT' represents a wonderful opportunity to acquire a rare right-hand drive example of this landmark Ferrari Gran Turismo.

£140,000 - 180,000
€160,000 - 210,000

318

917 miles from new

2017 ASTON MARTIN VANQUISH S COUPÉ

Registration no. VA17 XPM

Chassis no. SCFLCKZ3HGJ03547

- *Aston Martin's ultimate super GT*
- *Present ownership since July 2017*
- *917 miles at time of cataloguing*
- *Immaculate condition*
- *Complete with Aston Martin purchase pack*



'Vanquish sits proudly at the top of the Aston Martin model range. As our flagship Grand Tourer it represents the height of our design, engineering, technology and craftsmanship. ...it is a car of unprecedented ability, it is the very essence of Aston Martin.' – Aston Martin.

An entirely new Aston Martin for the 21st Century, the original Vanquish debuted at the Geneva Auto Show in March 2001 with deliveries commencing a few months later. Styled by Ian Callum, the man responsible for the DB7, the V12-engined Vanquish took over from the Vantage V8, the Newport Pagnell factory undergoing an extensive multi-million pound refurbishment to accommodate it.

For the successor, '2nd Generation' Vanquish, production shifted to Aston Martin's new factory at Gaydon, from whence deliveries commenced in 2012. Developed from the Project AM310 concept car, the Vanquish utilised a new lighter chassis employing more carbon fibre than the existing DBS platform, as well as having all-carbon fibre bodywork.



The exterior styling had evolved from that of the DBS, with styling cues such as the elongated side strakes clearly inspired by the exclusive, limited edition One-77, while the boot lid featured an integral rear spoiler. The One-77's influence also extended to the interior, which boasted hand-stitched leather and Alcantara.

Beneath the bonnet there was an upgraded version of Aston Martin's flagship AM11 V12 engine producing 565bhp and 457lb/ft) of torque, while the transmission was an 'Touchtronic II' six-speed paddle-shift automatic. In August 2014 Aston Martin announced an improved specification for the Vanquish, which included an eight-speed 'Touchtronic III' gearbox and an AM29 V12 engine producing 568 horsepower. Top speed increased to 201mph and the 0-60mph time - aided by launch control - dipped to 3.6 seconds.

Keeping all this in check were ventilated carbon ceramic discs all round, gripped by six-piston callipers at the front and four-piston units at the rear. Suspension was by double wishbones front and rear, controlled by a three-way-adjustable adaptive damping system offering Normal, Sport, and Track modes.

Built initially as either a two-seater or 2+2 coupé, the Vanquish also became available in 2013 as a Volante convertible, which was unveiled to an appreciative public at that year's Pebble Beach Concours d'Élégance. In November 2016, Aston Martin announced the new Vanquish S, which came with an up-rated engine (600bhp) and a new aerodynamic package at a cost of £199,950 in the UK.

This Vanquish S was first registered in June 2017 to a Mr Mike Flanagan, yet by the end of July 2017 had been acquired by the late Paul Jennings, its second owner. Representing a wonderful opportunity to acquire what, in its maker's own words is 'a masterful blend of art and technology', this beautiful British supercar comes complete with all books/tools, a V5C Registration Certificate, and its original factory purchase pack from Aston Martin Reading.

Please be advised that due to the limited number of kilometers recorded on the odometer, this Lot may incur a VAT liability upon registration in any EU country other than the UK.

**£110,000 - 140,000
€130,000 - 160,000**

1972 PORSCHE 911S 2.4-LITRE COUPÉ

Registration no. DRY 704K

Chassis no. 9112300415

- *Delivered new in the UK*
- *Original registration number*
- *Last nut and bolt' restoration by marque specialist Paul Stephens (2014)*
- *Maintained by marque specialists Autofarm*
- *Present ownership since 2014*



A 'modern classic' if ever there was one, Porsche's long-running 911 arrived in 1964, replacing the 356 that had secured the fledgling company's reputation as producer of some of the world's finest sporting cars. The iconic 911 would take this reputation to an even more exulted level on both the road and racetrack.

The 356's rear-engined layout was retained, but the 911 switched to unitary construction for the bodyshell and dropped the 356's VW-based suspension in favour of a more modern McPherson strut and trailing arm arrangement. In its first incarnation, Porsche's single-overhead-camshaft, air-cooled flat six displaced 1,991 cc and produced 130bhp; progressively enlarged and developed, it would eventually grow to more than 3.0-litres and, in turbo-charged form, put out well over 300 horsepower. The first of countless upgrades came in 1966 with the introduction of the 911S. Easily distinguishable by its stylish Fuchs five-spoked alloy wheels, the 'S' featured a heavily revised engine producing 160bhp, the increased urge raising top speed by 10mph to 135mph. A lengthened wheelbase introduced in 1969 improved the 911's sometimes wayward handling, and then in 1970 the engine underwent the first of many enlargements, to 2.2-litres, in which form it produced 180bhp on Bosch mechanical fuel injection when installed in the top-of-the-range 'S' model.

All 911 variants received the 2.4-litre (actually 2,341cc) unit for 1972, by which time the 911S featured the stronger Type 915 five-speed gearbox and 6"x15" alloy wheels as standard. Porsche had already tried a 2.4-litre engine in endurance racing, the stretch being achieved by lengthening the stroke, but the impetus for the larger unit's introduction came from the USA's ever more stringent emissions laws. As installed in the 911S, the '2.4' produced 190bhp, while the most obvious external change from the 2.2-litre models was the addition of a small chin spoiler, adopted to improve high-speed stability. Porsche had built 1,430 2.4-litre 911S coupés by the time production switched to the 2.7-litre model for 1974. The '2.7' was the first 911 to incorporate the large impact-absorbing bumpers, disliked by many purists for whom the '2.4' is the last 'old school' 911 and therefore all the more collectible.

Delivered new to the UK and first registered on 18th January 1972, this Porsche 911S was purchased by the late Paul Jennings in July 2014 from marque specialist, Paul Stephens, who had acquired it in May 2013. The car had previously been modified and updated for rallying (miscellaneous upgraded parts, including a spare set of wheels, offered with the car), and was purchased by Paul Jennings part way through being restored and returned to road specification.



Undertaken by Paul Stephens, this was a ground upwards, 'last nut and bolt' restoration to the highest possible standard carried out by one of the UK's foremost Porsche experts (see bills totalling over £100,000 on file, as well as 6 CDs of restoration photographs). Absolutely no expense was spared and the attention to detail is exemplary. In the course of the rebuild, Paul Stephens replaced the uprated 2.7 engine that was in the car with a correct 2.4-litre 'S' unit, which was fully rebuilt and is in immaculate condition, performing perfectly. The Porsche was displayed on Paul Stephens stand at Goodwood when the restoration was finished.

In more recent years the Porsche has been maintained by marque specialists, Autofarm (invoices available). The very substantial history file contains assorted correspondence, details of previous owners, invoices dating back to 1983, a current V5C Registration Certificate, MoT to August 2018, and a Porsche Certificate of Authenticity. A wonderful opportunity to acquire one these highly collectible 2.4-litre Porsche 911S models, fully restored by one of the best in the business.

£100,000 - 140,000
€110,000 - 160,000



1963 LAND ROVER 80" SERIES I 4X4 UTILITY

Registration no. 386 UHW

Chassis no. 26104193

- *Desirable early model*
- *An older restoration*
- *Present ownership since 2015*
- *Restoration photographs on file*
- *Known to the Land Rover Series I Club*



Inspired by the US Army's wartime 'Jeep', developed in haste and intended for short-term, small-scale production, the Land Rover would defy its creators' initial scepticism. Rover bosses the Wilks brothers saw the need for a tough, four-wheel-drive, utility vehicle to serve the needs of the agricultural community in the immediate post-war years, but the Land Rover's runaway success took the company by surprise.

The necessity of using corrosion resistant aluminium panels at a time of severe steel shortage turned into a positive virtue in the Land Rover's sphere of operations, and the use of existing components - including the P3 saloon's 1,595cc, four-cylinder, sidevalve engine - kept production costs down and cut development time. Ruggedly built and simple in construction, the Land Rover proved capable of surviving in countries where conditions were primitive to say the least, a virtue that helped contribute to its worldwide acceptance. Indeed, it is estimated that two-thirds of all Land Rovers ever produced are still in existence today.

Built between 1949 and 1958, the Series I Land Rover was available in no fewer than five different wheelbase lengths ranging from 80" to 109". The original 1.6-litre petrol engine was soon superseded by a 2.0-litre unit (for 1952) and the company set about developing its own diesel, which was first offered in 1956. In the course of more than 60 years in production the supremely versatile Land Rover would prove itself adaptable to innumerable civilian and military roles. Its replacement is keenly anticipated.

Known to the Land Rover Series I Club, this 80" wheelbase model was not first registered until 1963, perhaps indicating that it had been in military or government service prior to that date. The late Paul Jennings acquired the vehicle in July 2015 from John Brown 4x4 of Thirsk. The purchase invoice is on file and the Landie also comes with a quantity of expired MoTs (most recent 2015), copy V5 registration documents, and numerous restoration photographs documenting an extensive rebuild, possibly undertaken during the 1990s.

£10,000 - 15,000**€11,000 - 17,000****No Reserve**

321

2015 LAND ROVER DEFENDER 110 XS DOUBLE CAB 4X4 PICKUP

Registration no. OV15 UYM

Chassis no. SALLDHSP7FA474839

- Dating from the last 12 months of Land Rover production
- One owner from new
- 2.2-litre turbo diesel engine
- Circa 6,000 miles from new



Following the successful reception of the all-new Land Rover Discovery model in 1989, it was decided to give the traditional Land Rover its own name: Defender. Making this more than merely a re-branding exercise was the introduction on the Defender of the 200Tdi turbo diesel engine that had debuted in the Discovery. This extensively revised power unit brought with it useful increases in maximum output (107bhp), torque (195lb/ft) and fuel economy (25%) when compared with the old normally aspirated diesel it was based on. Now boasting bold 'Defender' logos, the Land Rover continued its seemingly inexorable process of development, gaining disc brakes and power assisted steering as standard during the 1990s together with a host of other improvements, not the least of which was a new 300Tdi turbo diesel engine.

It was inevitable that advances in electronics pioneered in mainstream passenger cars would eventually trickle down to the utilitarian Land Rover, which by the new millennium had gained anti-lock brakes (ABS), Electronic Brakeforce Distribution (EBD) and Electronic Traction Control (ETC), all of which were aimed at improving traction to keep in front of its increasingly capable rivals. There was also a new Td5 five-cylinder turbo diesel engine. Steel doors, enabling the use of electric window lifts and central locking for the first time, were new for the 2002 model year, as were heated seats and a new model: the 110 Double Cab.

With increasingly stringent emissions control regulations just over the horizon, it was decided to downsize the four-cylinder turbo diesel from 2.4 to 2.2-litres. This new power unit made its appearance for the 2012 model year, and contrived to be just as powerful as its predecessor and delivering lower noise levels as a bonus.

Despite, or perhaps because of, being recognisably related to the very first Land Rover of 1948, the Defender has retained a steadfastly loyal customer base; indeed, in the UK in 2013 it even managed to out-sell the Range Rover. The kinds of incremental improvements mentioned above would continue to be made regularly until production of the traditional Land Rover Defender ceased and ended an era in January 2016.

Acquired new in June 2015 by the late Paul Jennings, this Defender Double Cab has covered circa 6,000 miles from new and is presented in commensurately good condition. Offered with a V5C Registration Certificate and two sets of spare wheels and tyres.

£18,000 - 24,000

€21,000 - 27,000

No Reserve

322

14 miles from new

2018 ROLLS-ROYCE DAWN CONVERTIBLE

Registration no. EO18 OFL

Chassis no. SCA666D08HU101370

- The height of soft-top luxury
- Purchased from P&A Wood in March 2018
- 14 miles from new at the time of cataloguing
- Immaculate condition throughout



'With the Dawn Drophead Coupé, every journey is an experience that reinvigorates body and soul. Every element thoughtfully and beautifully designed to complement the exhilaration of an unbroken summer. This is the thrill of drophead driving matched with the beauty of unparalleled Rolls-Royce craftsmanship.' – Rolls-Royce.

Vickers' controversial sale of its Rolls-Royce and Bentley brands in 1997, although acrimonious at the time, allowed the two marques to reaffirm their traditional roles in separate ownership: Rolls-Royce continuing to provide the ultimate in luxurious motoring for the plutocracy under BMW's stewardship, with Volkswagen-owned Bentley catering for the wealthy owner-driver with sporting inclinations. Concluded in 1998, the deal left VW in control of the Crewe factory and it was not until January 2003 that Rolls-Royce would be officially re-established at its new home close to Goodwood, just a moments drive from this auction.

An historic model in the continuing story of the Rolls-Royce marque, the Dawn Drophead Coupé was introduced to the public at the 2015 Frankfurt Motor Show, reviving, at least in part, a great name from Rolls-Royce's past that had always been synonymous with unrestrained luxury.

Although based on the Wraith fixed-head coupé, the Dawn had undergone extensive re-engineering to achieve its maker's aims of building 'the quietest open-top car ever made' and 'the most rigid four-seater convertible available today'. Some 80% of the Dawn's outer panels were new, though the Wraith's rear-hinged 'coach doors' were retained. Some boot space was sacrificed to accommodate the folded-down convertible hood, leaving the cabin space undiminished, with the fold-down time an impressive 20 seconds. At almost 5.3m (17' 4½") in length, the Dawn is an impressive and commanding motor car.

The Wraith's 48-valve 6.6-litre twin-turbocharged V12 was retained for the Dawn, its maximum output of 563bhp being sufficient to propel the 2½-ton luxury express to 60mph in a mere 4.8 seconds on its way to a (governed) top speed of 155mph (250km/h). This abundance of power is transmitted to the rear axle via a ZF eight-speed automatic gearbox, while air-sprung suspension and automatic level control ensure that ride quality remains un-compromised.

'This is feelgood motoring with a capital F,' declared *Car* magazine. 'The interior has a clear focus on pampering: the seats are huge and plump and upholstered in the finest leather front and rear - you sink into their hide-bound grasp and never want for support.'



'Goodwood calls the Dawn "the world's only true modern four-seater super-luxury drophead" and we wouldn't disabuse them of this notion. There is space front and rear aplenty and it's incredibly hushed, roof up...' In fact, the Dawn (roof up) manages to be a couple of decibels quieter than the Wraith, cruising in unnatural silence.

Autocar was equally impressed: 'If you're in the bracket and you like refinement in your big convertibles, this Rolls-Royce must be the ultimate choice. We have never ridden in a car of this layout that is so quiet or so smooth, or deals so brilliantly with the slings and arrows of difficult roads, with no handling compromises. In those respects, it simply sets a brand new standard.'

Purchased from P&A Wood on 5th March 2018, Mr Jennings sadly never took delivery. Consequently, this stunning Rolls-Royce Dawn has covered a mere 14 miles from new and is presented in 'as new' condition throughout.

Please be advised that due to the limited number of kilometers recorded on the odometer, this Lot may incur a VAT liability upon registration in any EU country other than the UK.

**£190,000 - 230,000
€220,000 - 260,000**



For details of the charges payable in addition to the final Hammer Price of each Lot please refer to paragraphs 7 & 8 of the Notice to Bidders at the back of the catalogue.



323

BRIAN JAMES A4 CAR TRANSPORTER TRAILER

Chassis no. SJB1256GBPGD011322

'The Transporter range represents the ultimate evolution in trailer design, with a strong, durable galvanised chassis and low bed height. Transporter trailers are perfectly suited for vehicle recovery, professional transport and motorsport alike. Transporter trailers are available with load bed lengths from 2.70m to 5.00m, in single or twin axle variants. All feature internally stored 'easy glide' ramps and a flush fitting centre deck.' – Brian James Ltd.

One of Britain's foremost specialist manufacturers, Brian James Ltd has been making trailers for a wide variety of uses since 1979, that offered here being a fully galvanised, twin-axle car transporter trailer. Noteworthy features include an electric winch, storage area with straps and a Datatag anti-theft system. The trailer's vital statistics are as follows:

Gross weight: 2,600kg
 Gross capacity: 1,905kg
 Overall trailer length: 6.54m
 Overall trailer width: 2.38m
 Internal bed width: 2.0m
 Bed load height: 0.42m

£2,000 - 2,100
€2,300 - 2,400
No Reserve



324

ASTON MARTIN 4-LITRE ENGINE

Engine no. 400/1553

'Racing has played a major part in the development of all Aston Martin engines since Frank Halford designed the original 1.5-litre unit for Bamford & Martin. The 3,995cc 6-cylinder light alloy engine fitted to the DB5 is in all major respects the same as that which powered the 4-litre prototype which ran in the 1962 and 1963 Le Mans 24-Hour races.' – *Autocar*, 21st May 1965.

Aston Martin's post-war evolution took a giant step forward with the launch of the DB4 in 1958. The engine was still an all-alloy, twin-overhead-camshaft, six but the old W O Bentley supervised 3.0-litre unit had been superseded by a new design by Tadek Marek. The new 3,670cc engine featured 'square' bore and stroke dimensions of 92mm, and developed its maximum power of 240bhp at 5,500rpm. Enlarged to 4.0 litres by means of a wider (96mm) bore, a revised version of the Aston Martin six first appeared in the Lagonda Rapide, and in 1963 was standardised on the DB4's replacement: the DB5. On the standard arrangement of triple SU carburettors, this 3,995cc engine produced 282bhp, while from September 1964 the 314bhp, triple-Weber Vantage version became available.

The serial number suggests this engine left the factory fitted to a DB5 and was in fact previously installed in the DB5 from the Collection (lot 312), although it is not the original engine for that car. Current condition is unknown but understood to be operational when removed.

£3,000 - 3,100
€3,400 - 3,500
No Reserve

END OF COLLECTION



A single-owner collection including

**RARE BROUGH SUPERIOR
MOTOR CARS**



325

The ex-George Brough and in current ownership since 1972

**1935 BROUGH SUPERIOR 4.2-LITRE
'DUAL PURPOSE' DROPHEAD COUPÉ**

Coachwork by W C Atcherley

Registration no. WH 7238

Chassis no. 44601/CWC/1

- Owned and driven by George Brough for over 30 years
- Bought directly from his widow
- Present ownership since 1972
- Offered from long-term storage



George Brough proudly standing next to his Brough Superior 'WH 7238'

It was surely inevitable that a company whose products had earned the well-deserved sobriquet 'The Rolls-Royce of Motorcycles' would eventually turn to the manufacture of motor cars. George Brough's motorcycles were assembled from the finest available proprietary components, and he adopted the same approach to motor manufacturing, using the Hudson Terraplane chassis – also favoured by Railton – in both 4.2-litre eight-cylinder and 3½-litre six-cylinder forms. Birmingham-based coachbuilder W C Atcherley had bodied Brough's first Meadows-engined prototype of 1933 and was duly commissioned to provide the bodies for his latest venture.

Introduced in 1935, the production soft-top model featured Atcherley's patented 'dual purpose' coachwork in which the convertible hood folded down into the body rather than projecting rearwards as was usually the case. The result was one of the most beautiful and well-proportioned cars of its day. George Brough came up with the design for the radiator grille, which had been inspired by the shape of his motorcycles' fuel tank, while inside the car was a new dashboard equipped with British-made instruments and switches. There was further 'Anglicisation' in the form of Lucas lighting, Luvax shock absorbers, and a Smiths Jackall hydraulic jacking system, while the electrics were upgraded from 6 to 12 volts.



Threatened with legal action by Railton's aggrieved founder, Noel Macklin, Hudson was soon forced to stop supplying the eight-cylinder chassis to Brough, leaving George with a six-cylinder range only. When production ceased in 1939, an estimated 25 eight-cylinder and 50 six-cylinder Brough Superiors had been made, making them among the rarest of fine quality British sporting cars of the 1930s.

'WH 7238' is one of the first series of 25 eight-cylinder cars made in 1935 and was first registered on 7th February 1936 in Bolton, Lancashire. Correspondence and a photograph on file reveal that the car was first owned by one William Smithie, a friend of George Brough's. The history file also contains an original letter from Mrs E C Brough, numerous MoT certificates, an original 'Brough Superior' logbook sleeve, old-style V5/V5C documents, and an old-style continuation logbook in George Brough's name (issued 1948).

Accepted in part exchange for a new six-cylinder Brough in 1940, by which time it had covered around 78,000 miles, 'WH 7238' served thereafter as George Brough's personal transport - being nicknamed 'Old Faithful' on account of its faultless reliability - and was still in his ownership at the time of his death in November 1970. In 1972, the Brough was purchased by the current vendor - already the owner of a six-cylinder Brough - from George's widow, Connie Brough, at the Broughs' Nottingham home, 'Pendine', having been advertised in *The Sunday Times*.

During the war, the rear seats had been removed and George used the car to deliver Rolls-Royce Merlin engine crankshafts (five at a time) which had been manufactured at the Brough works. It was said that he would drive through the night on full headlights, a rare dispensation at a time of total blackout. On one occasion, George collided with some level crossing gates. As might be imagined, this accident had an adverse effect on the rear suspension and the body frame, so in its new ownership the car was dismantled by Ian Johns, owner of another eight-cylinder Brough. It was then re-framed, repainted, fitted with new suspension, and had its engine rebuilt having covered in excess of 360,000 miles. The car's distinctive foot-plates were fitted at this time. Since then, 'WH 7238' has been used extensively, attending several European rallies, and in 1983 was taken to the FIVA World Rally in the USA, which it won.

The car is offered for sale from long-term storage, and it is expected that it will have been got running by time of sale. Nevertheless, further re-commissioning will almost certainly be required before it returns to the road. Accompanying documentation consist of a green continuation logbook, numerous expired MoTs, and old-style V5/V5C Registration Certificates. A truly remarkable motor car with impeccable provenance, 'WH 7238' represents a wonderful opportunity to own an example of this ultra-rare and highly desirable 'Post-Vintage Thoroughbred', possessing the unique cachet of having been owned and driven by its maker.

£100,000 - 150,000
€110,000 - 170,000

1938 BROUGH SUPERIOR 4½-LITRE V12 SPORTS SALOON

Coachwork by Charlesworth

Registration no. FAU 999

Chassis no. 500/1

- *The only example completed*
- *An older restoration*
- *Offered from long-term storage*
- *Re-commissioning required*



It was surely inevitable that a company whose products had earned the well-deserved sobriquet 'The Rolls-Royce of Motorcycles' would eventually turn to the manufacture of motor cars. George Brough's motorcycles were assembled from the finest available proprietary components, and he adopted the same approach to motor manufacturing, using the Hudson Terraplane chassis – also favoured by Railton – in both 4.2-litre eight-cylinder and 3.5-litre six-cylinder forms. Birmingham-based coachbuilder W C Atcherley had bodied Brough's first Meadows-engined prototype of 1933 and Charlesworth was duly commissioned to provide the bodies for his latest venture.

Threatened with legal action by Railton's aggrieved founder, Noel Macklin, Hudson was soon forced to stop supplying the eight-cylinder chassis to Brough, leaving George with a six-cylinder range only. Despite this setback, George had not given up the idea of producing the ultimate sporting luxury car. For his new venture he chose the smaller (4½-litre) of the two Lincoln Zephyr V12 engines available, although on this occasion the chassis was to be Brough's own, drawn up by George's long-time collaborator, engineer Harold 'Oily' Karslake. Its side members excepted, the chassis was made at the Brough works and assembled using arc welding, believed a 'first' for the British motor industry. No rivets were used in its construction.

For the V12's body, George turned to Charlesworth, suppliers of coachwork to Alvis, the firm regarded as Brough's principal rival. An early example of 'razor edge' styling (designed by George Brough himself), the long, low body was fronted by a distinctive angular radiator grille and blessed with a particularly generous boot. In an article penned for *Veteran and Vintage magazine* (copy on file), Harold Karslake states that 'the seating was to be as roomy and comfortable as possible, ample leg room, easy of access, good headroom, and above all excellent visibility all round. All seats within the wheelbase, and ample luggage space'. The chassis was priced at £850 and the four-door saloon at £1,250.

In his definitive book on the marque, *'Brough Superior The Complete Story'*, Peter Miller states that three V12 chassis were laid down but only one car is known to have been completed pre-war. Photographs exist of this car carrying two different registrations: '297 AU' and 'FAU 999', the former being a Brough 'factory plate' and the latter the one it was sold with. In a letter on file, Harold Karslake confirms that the V12 Brough was a 'one off'.



Of the V12's performance, Karslake observed that 'no vibration whatever could be felt from the power unit, and the only indication that the engine was running was the green jewel on the dash indicating pressure in the oil circuit', while 'the extreme rigidity of the chassis frame and the flexible mounting of the body on the sides of the chassis ensured absence of and body noises of any sort'.

The earliest registration document in the history file is an old-style buff logbook issued in May 1949, listing the owner at that time as one Thomas Hitchon of Grange-over-Sands, Lancashire. He was followed (in 1951) by Thomas Cogswell MBE, who kept the Brough until 1966 when it was sold to John Dyson of the Railton Owners Club (purchase receipt and correspondence on file). Also on file is a letter from George Brough to Mr Cogswell stating that he remembers the latter taking delivery of 'FAU 999' so, presumably, it passed from Hitchon to Cogswell via the Brough works. George also confirms that it is the only car of its kind ever produced. The history file also contains numerous other letters; a quantity of (copy) technical literature; a selection of period photographs; sundry invoices; old V5 registration documents and expired MoTs; and a copy of *The Autocar* featuring a review of the Brough V12.

The present owner purchased the V12 from John Dyson in August 1976. At that time, the car had been completely dismantled mechanically, and the engine was thought to be irreparable. Fortunately, the owner was able to obtain a new short block engine from France where it had been buried in its crate during the war to prevent it falling into German hands. The Brough's mechanicals were rebuilt over a period and gradually reassembled.

Initially, the car was plagued with overheating problems, but a greatly enlarged radiator, specially made to fit all the available space, solved this problem with no outward change to the car's appearance. The vendor was then able to drive the Brough to Brooklands and back on a fairly warm day with no problems.

The car is offered for sale from long-term storage of some 25 years, and it is expected that it will have been got running by time of sale. Nevertheless, further re-commissioning will almost certainly be required before it returns to the road.

£15,000 - 25,000
€17,000 - 29,000

327

1937 BROUGH SUPERIOR 3½-LITRE SALOON

Coachwork by W C Atcherley

Registration no. EAU 30

Chassis no. 42137

- *One of an estimated 60 six-cylinder cars made*
- *One of only three six-cylinder saloons known to survive*
- *An older restoration*
- *Offered from long-term storage*





It was surely inevitable that a company whose products had earned the well-deserved sobriquet 'The Rolls-Royce of Motorcycles' would eventually turn to the manufacture of motor cars. George Brough's motorcycles were assembled from the finest available proprietary components and he adopted the same approach to motor manufacturing, using the Hudson Terraplane chassis – also favoured by Railton – in both 4.2-litre eight-cylinder and 3½-litre six-cylinder forms.

Birmingham-based coachbuilder W C Atcherley had bodied Brough's first Meadows-engined prototype of 1933 and was duly commissioned to provide the bodies for his latest venture. George Brough came up with the design for the radiator grille, which had been inspired by the shape of his motorcycles' fuel tank, while inside the car was a new dashboard equipped with British-made instruments and switches. There was further 'Anglicisation' in the form of Lucas lighting, Luvax shock absorbers, and an optional Smiths Jackall hydraulic jacking system, while the electrics were upgraded from 6 to 12 volts.

Threatened with legal action by Railton's aggrieved founder, Noel Macklin, Hudson was soon forced to stop supplying the eight-cylinder chassis to Brough, leaving George with a six-cylinder range only, which now included a four-door saloon by Atcherley. With 100bhp on tap, the Brough Superior 3½-Litre was good for a top speed of 90mph, with 60mph achievable from rest in 12 seconds. Prices were on a par with the contemporary 20hp Alvis at £665 (drophead) and £695 (saloon). When production ceased in 1939, an estimated 25 eight-cylinder and 50 six-cylinder Brough Superiors had been made, making them among the rarest of fine quality British sporting cars of the 1930s.

This six-cylinder Brough was in a poor state when purchased and has been completely rebuilt and repainted by marque specialist Ian Johns over a three-year period. It has had very little use since the rebuild. The car is offered for sale from long-term storage, and it is expected that it will have been got running by time of sale. Nevertheless, further re-commissioning will almost certainly be required before it returns to the road. Accompanying documentation consists of some 'as found' and restoration-in-progress photographs, various old-style V5 registration certificates, sundry expired MoTs, and an old-style V5C.

£25,000 - 35,000
£29,000 - 40,000

328

The ex-Loel Guinness

**1951 BENTLEY R-TYPE CONTINENTAL
SPORTS SALOON**

Coachwork by H.J. Mulliner

Registration no. NME 61E

Chassis no. BC11A

- *The 11th Bentley R-Type Continental*
- *One of 208 produced*
- *Supplied new to France*
- *Known ownership history*
- *Present family ownership since 1978*
- *Bare-metal re-spray 2004*





'The vocabulary of motoring being a lame and limited thing, it is difficult to put into words the gulf that separates a Continental from the average car in all the qualities that have a bearing on safety at speed. In acceleration, in braking, in cornering power, in roadholding, in responsiveness to the controls, this Bentley is the equal of modern racing cars, and superior to some.' – Raymond Mays, *The Autocar*, 2nd October 1953.

Described by *The Autocar* as, 'A new stage in the evolution of the post-war Bentley,' the magnificent Continental sports saloon has been synonymous with effortless high speed cruising in the grand manner since its introduction in 1952 on the R-Type chassis. Of all-welded construction, the latter enabled the incorporation of a much-needed improvement to Rolls-Royce's standard bodywork in the shape of an enlarged boot together with associated changes to rear wings and suspension. The standard R-Type was a lively performer, achieving 106mph in silence and reaching 50mph from standstill in 10 seconds despite a kerb weight approaching two tons.

The Continental raised this already superlative combination of high performance and exceptional refinement to hitherto unattained levels. Unlike the ordinary 'standard steel' R-Type, the Continental was bodied in the traditional manner and first appeared with what many enthusiasts consider to be the model's definitive style of coachwork - the lightweight, aluminium, wind tunnel-developed fastback of H J Mulliner. In developing the Continental, Bentley Motors made every effort to keep its weight to the minimum, knowing that this was the most effective way to achieve the maximum possible performance.

Rolls-Royce's six-cylinder, inlet-over-exhaust engine had been enlarged from 4,257cc to 4,556cc in 1951, and as installed in the Continental benefited from an increase in compression ratio - the maximum power output, of course, remained unquoted but has been estimated at around 153bhp. As the Continental matured, there was – inevitably – an increase in weight, which was offset by the introduction of a 4,887cc engine on the 'D' and 'E' series cars, commencing in May 1954. The Continental's performance figures would have been considered excellent for an out-and-out sports car but for a full four/five seater saloon they were exceptional: a top speed of 120mph, 100mph achievable in third gear, 50mph reached in a little over 9 seconds and effortless cruising at the 'ton'.



Built for export only at first, the Continental was, once delivery charges and local taxes had been paid, almost certainly the most expensive car in the world as well as the fastest capable of carrying four adults and their luggage. 'The Bentley is a modern magic carpet which annihilates great distances and delivers the occupants well-nigh as fresh as when they started,' concluded *Autocar*.

The eleventh example completed, right-hand drive chassis number 'BC11A' was ordered for use in France by Mrs Loel Guinness and delivered via Franco-Britannic Automobiles. Born Gloria Rubio y Alatorre in Mexico, Mrs Guinness was the third wife of Thomas Loel Guinness, an MP and member of the eponymous brewing dynasty, though his branch of the family had made its fortune in banking and real estate. Known as 'Glorious Gloria', she was a well-known socialite and fashion icon. Dressed by the great European fashion houses, Gloria was photographed for *Vogue*, featured on the International Best Dressed List, and acted as a contributing editor to *Harper's Bazaar*. Loel Guinness was her fourth husband. Gloria Guinness died in Switzerland in November 1980, and many of her fabulous clothes now form part of the Victoria & Albert Museum's collection.



In January 1955, the Continental passed (via Franco-Britannic) to its second owner in France, ONE Lemaigre Dubreuil. Franco-Britannic also handled the sale of the Bentley to its third owner, one M Rambuteau, who acquired it in June 1964. In September 1967, 'BC11A' returned to the UK when Jack Barclay sold the car to its fourth owner, Guy May. The car subsequently passed through the hands of three more UK-based owners – Richard Seys, J Evan-Cooke, and J Gurney respectively – before passing into the ownership of the current vendor's family in November 1978 (purchase receipt on file).

These Series-A cars are considered the most desirable because they exemplify the Continental concept in its purest, and lightest, form. 'BC11A' was ordered with lightweight seats, a Jaeger trip chronograph, and a plain radiator (no cap or mascot), and was originally finished in Tudor Grey with maroon trim.

'BC11A' has the manual gearbox and right-hand gear lever; the latter is considered to be far superior to both the steering column and central gear changes, which have the disadvantage of additional linkages resulting in less precise shifting. A published road test of the right-hand gear change on an R-Type Continental noted that the expression, 'like a hot knife through butter!' was especially apt.

In 2002, 'BC11A' attended the R-Type Continental's 50th Anniversary Celebration at Silverstone, and the following year was treated to a professional restoration of the bodywork and interior. Carried out between November 2003 and July 2004, these works included repairs to panels, a bare-metal re-spray, partial re-trim (new carpets, headlining, etc), refurbishment of woodwork, re-plating of brightwork and much more besides. Details of the works carried out are on file together with photographs of the Bentley in bare metal prior to the re-spray.

The car is offered with its original handbook, workshop manual, first UK logbook (issued 1967), various articles, assorted correspondence, and other historical documentation. Presented in running order, 'BC11A' represents a rare opportunity to acquire a fine example of the most famous post-war Bentley, possessing impeccable provenance.

£750,000 - 950,000
€860,000 - 1,100,000

END OF COLLECTION

329

1953 MERCEDES-BENZ 300 CABRIOLET

Registration no. OXP 2

Chassis no. R 186014-3501890

- *Rare UK right-hand drive model*
- *Delivered new to London*
- *Matching registration, chassis, and engine numbers*
- *Professionally restored with no expense spared (2014-2017)*
- *Exceptional condition throughout*



More expensive than the 300 SL sports car and almost double the price of the contemporary top-of-the-range Cadillac, the Mercedes-Benz 300 was one of the world's most exclusive automobiles. It is also historically significant as one of Mercedes-Benz's first all-new designs of the post-war era, debuting at the Frankfurt Auto Show in 1951. The 300's arrival re-established Mercedes-Benz in the front rank of prestige car manufacturers, marking as it did a return to the marque's tradition of building high-performance luxury automobiles of the finest quality.

'To the characteristics of high performance, impressive appearance and fine detail finish which distinguished the big Mercedes models of pre-war days are added new virtues of silence, flexibility and lightness of control, while the latest rear suspension, a product of long experience on Grand Prix cars and touring cars, confers a degree of security at high speeds on rough and slippery surfaces which it would be very difficult indeed to equal,' observed *Autocar* magazine.

Although Mercedes-Benz would adopt unitary chassis/body construction for its lower and mid-priced cars as the 1950s progressed, the retention of a traditional separate frame for the 300 enabled a wide variety of coachbuilt body types to be offered. The 300's cross-braced, oval-tube chassis followed the lines of the 170 S and 220, with independent suspension all round and four-wheel drum brakes, but incorporated the added refinements of hypoid bevel final drive, dynamically balanced wheels and remote electrical control of the rear suspension ride height.

Initially developing 115bhp, the 3-litre, overhead-camshaft, six-cylinder engine - used in fuel-injected form in the 300 SL sports car - was boosted in power for the succeeding 300b and 300c models, finally gaining fuel injection in the re-styled 300d of 1957.

Custom built by Mercedes-Benz's most experienced craftsmen, the Mercedes-Benz 300 was luxuriously appointed and trimmed with materials of the highest quality. Fast and elegant, it was one of very few contemporary vehicles capable of carrying six passengers in comfort at sustained high speeds. The 300 was the car of choice among West German government officials, and throughout Europe and the USA was widely favoured by businessmen, financiers, film stars, and politicians. Indeed, 'Adenauer' became the 300's unofficial model name, after German Chancellor Konrad Adenauer, its most famous customer. Priced at DM23,700 in 1953, the 300 Cabriolet was among the world's most expensive automobiles of its day, costing some 50% more than the average UK house.

A most worthy upholder of the Grosser Mercedes tradition of pre-war years, this rare 300 cabriolet is one of only 181 built during 1953 out of a total convertible production of 591. Manufactured in December 1953, this car was one of the very few built in right-hand drive configuration, as confirmed by the copy data card, and was delivered new to London where it was registered in February 1954. It is estimated that as few as seven right-hand drive convertibles were built for the UK market. The identity of the original owner is not known, though whoever it was must have possessed a certain amount of courage to drive his/her luxurious German motor car around the streets of a city that still bore all too many signs of war.



The current owner purchased the Mercedes in January 2014 from a Midlands-based restorer but decided to manage the rebuild himself, a painstaking process that would occupy the next four years. He was able to obtain many missing parts from the previous owner, who had stripped the car before selling it to the restorer, but the severely corroded floor pans presented a major problem. Wanting to use only genuine Mercedes-Benz parts, and with replacements no longer available, the only solution was to obtain a suitable donor car. Amazingly, another right-hand drive 300 (a saloon) was found in Poland, purchased, and its immaculate floor pans transferred to 'OXP 2'.

All body panels were stripped back to bare metal and E coated to preserve it for the future, the chassis drivetrain and suspension components were all sand or vapour blasted before paint or powder coating. Then chassis, suspension, brakes, engine, and gearbox were all rebuilt, with any new parts required being obtained from marque specialists Neimoller of Mannheim, Germany. The engine was stripped totally, the crankshaft being reground; new pistons/rings, bearings, and valves fitted; the oil pump re-engineered to increase oil pressure; and all parts balanced and/or skimmed where appropriate. It was then reassembled by Anthony Seddon, who builds historic F1 cars, F3 cars, and touring cars.

Fortunately, the interior was in good enough condition to be reused in its entirety - being re-trimmed by an ex-Bentley craftsman with 30 years experience - as was the window glass and all brightwork. The Bosch headlights and spotlights are likewise original items, refurbished at considerable expense. Every nut and bolt used was taken from either the original or the donor car, ensuring complete authenticity. This concern for originality is reflected in the fact that, despite having some minor blemishes, the original rear bumper and number plate plinth were reused rather than being replaced with pattern parts. Built to fit the original cowl, the radiator core is one of the relatively few new parts used. As one would expect, the hood and headlining had to be made anew, the correct fabric being sourced from a specialist in the USA. Repainting the body in its original deep black livery took all of six months to complete, and the quality of finish achieved is quite outstanding.

Offered with restoration invoices and a full photographic restoration history, UK V5C Registration Certificate, this sublime Mercedes-Benz 300 Cabriolet represents a wonderful opportunity to acquire an ultra-rare right-hand drive example of one of the world's most coveted automobiles, eligible for a variety of the most prestigious historic motoring events.

£220,000 - 280,000
€250,000 - 320,000

330

The John Surtees, one-owner from new

1957 BMW 507 HIGH-PERFORMANCE COUPE

UK Reg No: 22 GKN

Chassis Number: 70067

- *Bought for John Surtees by Count Domenico Agusta*
- *One of only 252 built*
- *Unique superior specification*
- *Dunlop disc brakes all round*
- *Offered for sale by the Surtees family*
- *Immaculate condition*



1
John Surtees taking delivery of his brand new 1957 BMW 507 Roadster at the factory, having just won the 500CC Motorcycle World Championship with MV Agusta the previous year.

2 (part lot)
Confirmatory copy letter.

Bonhams has been truly privileged to have been selected by the family of the late, great, multiple World Champion motor-cycle rider and racing driver John Surtees CBE, to offer this most outstanding – absolutely perfect provenance – extremely rare (and intensely gorgeous) BMW 507 Coupe which he owned absolutely from new for effectively 70 years...

Within the documentation file accompany this mouth-watering motor vehicle is a confirmatory copy letter dated February 10, 1959. The original was on 'Meccanica Verghera SpA'-headed notepaper – manufacturers of MV-Agusta motor-cycles - and the text reads:



2

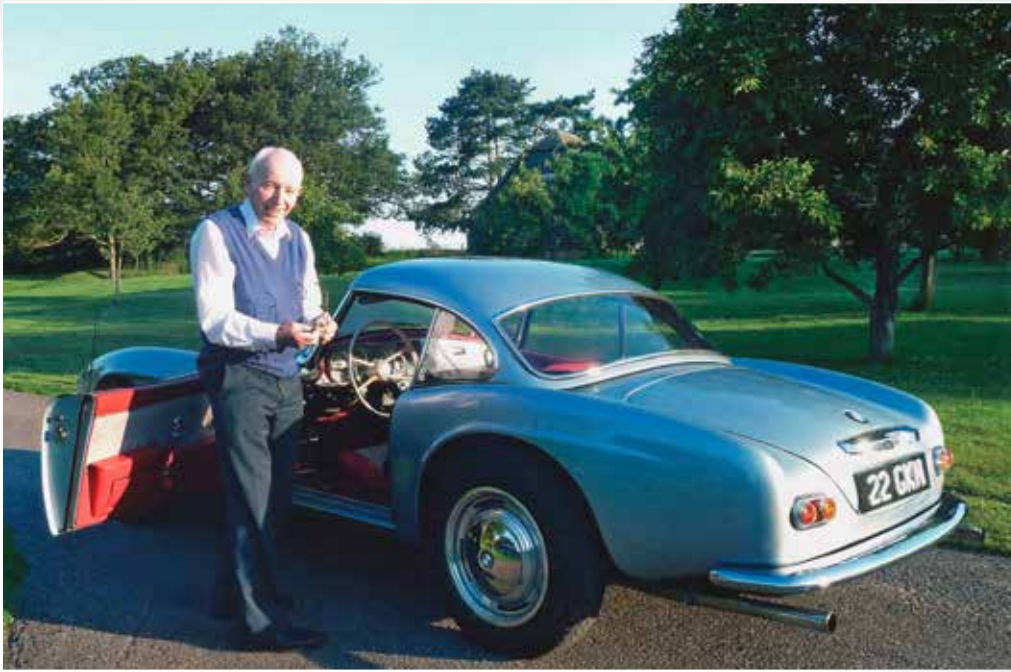

The same documentation file also includes a draft text written by the great World Champion himself, detailing the history of this magnificently well-preserved and immensely attractive, pioneering BMW. John Surtees:

“The Story of my BMW 507

“I was well established in my motorcycling career when I finally drove a car This was a Jowett Jupiter that saw in a showroom window on a day that the heavens had opened and I was riding a big Vincent Rapide to the factory at Stevenage The Jowett was a super little car and I enjoyed it immensely

“My father was doing a little business with the AFN company who were the BMW and Porsche importers. One day I went with him and was given the opportunity of trying a 356 Porsche. That again was a superb car. I experienced my first ever spin in it as it handled somewhat different to the Jowett.

“Fast forward to my first year with the MV-Agusta team 1956. At the time I had reverted to a Ford as it was more convenient because of all the equipment I would carry. The season went well with my winning my first TT and, whilst lying in a German hospital in Stuttgart following a crash in the 350cc race at Solitude, I also became World Champion. Count Agusta was delighted and, perhaps thinking that my terms hadn’t been that generous, he said ‘We must buy you a prize, do have a think’.

“I went away and did some serious thinking. There were a number of cars that quite excited me but I had done nothing about it. In 1957 at the start of the season I went to a race event at Hockenheim in Germany. There I saw my old friend and BMW development head Alex von Falkenhausen. What interested me was the beautiful car that was standing alongside the BMW pit. Alex saw me looking at it and said to take it for a run. So I jumped in and drove it all around those woodland roads which then existed at Hockenheim, and liked what I saw. Alex, when returned, introduced me to one of the sales directors who said ‘John these cars are very very rare and if you wanted one we would have to allocate it specially and would advise you’...” (once it would be ready for delivery). “After a few days they advised me I could have one possibly in July and told me the colour, interior and specification it had to be. I was excited...” (John independently described how BMW’s earnest German sales staff described the car’s colour in a rather dull way as being “...just silver-grey...” whereas “...it is really more a lovely, subtle, silver-blue.”) His written account continues: “I went to Count Agusta and said I knew what I would like. It was a 507 BMW. His first words were how much? To which I replied £3,200. Both of us...” (were) “...managing to converse in the Italian I was developing. There was a hesitation so I went in and said 50%, and we had an agreement.







1957 BMW 507 HIGH-PERFORMANCE COUPE



"The MV Agusta team was based at Gallarate which is just on the side of Milan airport at Malpensa. I could therefore take a route through using the Brenner and dropping into Munich where the BMW..." (company) "...was based. I collected my car and drove it carefully back again through to Italy. I did the trip a number of times as well as the trip to England.

"When the car was fully run in I asked to speak to Alex von Falkenhausen. I said to him the car was not like his. 'It goes up the mountains too slow and down the mountains too fast'. He replied "Yes I do have more horsepower in my car and can improve yours as well, we will do that. On brakes it is an opportune moment because we are working with Dunlop in England on introducing disc brakes and you can be part of that development programme".

"It was therefore agreed that I should take my car to Fort Dunlop and they would fit the car with four-wheel disc brakes. I think it is the only 507 in the world with this arrangement.

"I carried out a lot of development running until I had provided the information required. In relation to speed, when the engine performance had been improved, the car had been fitted with a full under-belly fairing which gave it something like 10-15 mph more top speed. The most speed I ever did in it was on the Gallarate to Milan Autostrada - with the help of a little downhill section and good weather the car went over the 140 mph..." (mark).

"I continued to run the car taking it to most of the Grand Prix..." (races) "...I went to normally with my team mate John Hartle. To get more luggage space I removed the hood from inside the hardtop so that I could have the back shelf available We have since replaced the original hood.

"As I said, the car was used continuously up until I joined Ferrari. On joining them at the end of 1962 Enzo Ferrari came out of his office after we had made an agreement and said 'German car, not possible' I thought I was going to be given a Ferrari. But that didn't happen, (although) I did end up with a 330 GT..." (for which Ferrari docked the price from John's driving fee! – see below).

"I (finally) drove the BMW home and basically laid it up in the garage. My father had a very good friend he did business with who lived in Barnet and had cafes in both Dunstable and just off the Great North Road. He had previously hired from me one of the rather special motor-cycles I had built. Dad called me and said 'Mr Greenfield would love to have the BMW'. I was very dubious but on checking where it was going to be and where it was going to be driven, I agreed. So for a short time the car was hired to Mr Greenfield who treated it extremely well and never in any way pressed it. He just had (the) pleasure, as with the motor-cycle, of driving between his various venues with special pieces of equipment.

"When I moved and had more accommodation I took the BMW back and it has been in my possession ever since."

John concluded this wonderful personal memoir of BMW 507 '22 GKN' as follows, describing it as:

"A car with many memories and one where purely its original specification makes it very very special."

Which really says it all – and we can most sincerely now commend this wonderful connoisseurial automotive objet d'art to the market.



1957 BMW 507 HIGH-PERFORMANCE COUPE



The late, great John Surtees CBE was the most competitive man that most figures within world-class motor-cycle and motor racing would ever recall having encountered, having raced against, or having worked with. John Surtees was just unusually intensely driven. And it was such intense drive, such focused dedication, that earned him no fewer than seven World Championship titles on motor-cycles, followed by his 1964 victory in the Formula 1 Drivers' Championship for Ferrari, and his 1966 CanAm Championship win (with unlimited-capacity sports-racing cars) for Lola-Chevrolet..

In 1956 he first won the coveted 500cc Motor-Cycle World Championship for MV – the company's first title victory in the senior class, and he would go on to add not only the 350cc World titles of 1958-59-60, but also a matching hat-trick of further 500cc titles.

His 1958 season with MV-Agusta had been simply staggering - 23 consecutive race wins plus both the 350cc and 500cc crowns – after which he was invited to the BBC TV *Sportsman of the Year* bash. He found himself seated there beside Ferrari's new English Formula 1 World Champion Driver Mike Hawthorn.

John would recall how: "Mike told me 'Four wheels stand up on their own better than two, have a go at four!'". The owners of both the Aston Martin and Vanwall works racing teams were seated at that same table and they wholeheartedly supported Hawthorn's suggestion. John Surtees consequently test-drove both sports and Formula 1 Aston Martins and an ex-Moss F1 Vanwall right here at the Goodwood Motor Circuit. For 1960 he was tied exclusively to MV-Agusta for motor-cycle racing, but Count Agusta would only enter the World Championship-qualifying events, leaving John forbidden from riding other makes in between. "So I decided to try my hand at racing cars instead..."

And the rest of his career tale – as recounted elsewhere in this catalogue – is familiar history. When he signed with Ferrari for their 1962 Formula 1 and World Championship GT and sports car racing programmes, *Il Grande John* was returning to an Italian factory team. "The Old Man..." (Mr Ferrari) "...always liked racing motorcyclists because he used to say 'They have fire in the belly – I like my team to have fire in the belly'. But when I first visited him in Maranello the car I was driving..." – as related in his own surviving text, above – "could have blown the deal!"





“A car with many memories and one where purely its original specification makes it very very special.”

- John Surtees CBE

He would preserve, maintain and adore this much-loved – and much admired - BMW 507 until he sadly died – aged 83 - on 10 March last year. And he used this graceful Grand Touring car extensively, often driving over the Brenner and Simplon passes on his way to-and-fro between England and Italy – revelling in its long-legged gait and considerable contemporary level of cockpit comfort and refinement. Hearsay recollections from BMW Classic advise us that as a special sports version – augmented to director von Falkenhausen’s instructions – the V8 engine of John Surtees’s ‘22 GKN’ offered here provided around 165bhp thanks to its compression ratio having been raised to 9.0:1, while the unit was also fitted with larger 42/38mm diameter valves and big 36NDIX carburettors. The engine reputedly also featured a special high-lift camshaft “with leverage increased to 1.70:1, instead of the 1.53:1 of the production engines to give higher valve lift”.

As related in his written account, owning this gorgeous BMW was also a two-edged sword. When he signed for Ferrari in late 1962, and arrived at the Maranello factory in his beloved BMW, Enzo Ferrari declared that he could not possibly drive a German car while racing for his team. He must have a Ferrari instead! In conversation John would tell the story like this: “Delivery of one was agreed and I thought ‘Ooh, this is good’ - but when I got my first pay cheque I found The Old Man had had the price of the new car deducted from my fee!”

Today – this one-owner-from-new BMW 507 is not only a beautiful example of BMW’s most rare, elegant and refined sports car from the 1950s – of which only 252 were ever made. It is in fact unique.

It is very much ‘The John Surtees BMW 507’ - a uniquely-connected one-owner beauty, now being offered for the very first time at public auction - direct from the estate of one of the world’s most revered and successful sportsmen - an eight-time World Champion, no less. Bonhams Festival of Speed Sale truly now truly offers a genuinely once-in-a-lifetime opportunity for a true connoisseur to add ‘John the Great’s Germanic V8 beauty to his or her collection – absolutely a jewel in the crown, indeed.

£ 2,000,000 - 2,500,000

€ 2,300,000 - 2,900,000

Please note: Special bidder registration procedures apply to this Lot. If you intend to bid on this Lot you need to register your interest with Bonhams no less than 48 hours in advance of the Sale. Please also refer to the Guide for Buyers Page at the front of the catalogue.







1957 BMW 507 HIGH-PERFORMANCE COUPE





JOHN SURTEES (1934 - 2017)

THE ONLY MAN EVER TO WIN World Championship titles on both two wheels and four – that was Britain's outstanding road racing warrior of the 1950s-1970s, John Surtees.

Dedicated, outspoken, totally focused upon his racing, Surtees was a simply brilliant motor-cyclist who then built a new career as one of the fastest racing drivers of his day.

His father, Jack Surtees, was a garage proprietor from Kent, and had been an effective racing motor-cyclist. John became proud owner of his first motor-cycle when he was only 11. He left school at 15, and began work immediately in his father's garage business as a mechanic. In 1950 he made his competition debut as sidecar passenger on his father's racing combination, and his solo debut followed in 1951 on a grass track at Luton.

He won his first race aged 17 on the Kentish circuit at Brands Hatch, and by 1955 had not only beaten the great Geoff Duke but had won 68 of his 76 races in that season alone.

His reward was an offer from Count Domenico Agusta in Italy to join the mighty MV-Agusta factory team for the 1956 season. John promptly ended the year as 500cc World Champion and would add six more World titles to his trophy cabinet by the end of 1959. He enjoyed working in Italy with the Italian team, and they came to adore him because all Italian racing mechanics – and the *tifosi* – simply love a real Racer.

John Surtees was all of that, and more...

With his firm grounding in practical technicality he recognised the importance from the outset of optimising the equipment that he raced, and he would spend tireless hours with engineers and mechanics ensuring that any obtainable advantage was built-in to his motor-cycles before he would even ride them to the start line.

The Italians in fact doted upon him. To them, this wiry but broad-shouldered figure became *Il Grande John* – 'John the Great' – and when he turned to four wheels in 1960 the British motor racing press mistranslated this as 'Big John'. The tag seemed to stick with him, despite being really rather inappropriate.

It had been in 1955, that Norton's celebrated racing director and chief engineer Joe Craig had given Surtees his first factory sponsored ride. He finished that year by beating reigning World Champion Duke at Silverstone and then again at Brands Hatch. However, with Norton in financial trouble and uncertain about their racing plans, Surtees accepted an offer to race for the MV Agusta factory racing team, where he soon earned immense affection and respect.



In 1956 Surtees won the 500cc World Championship, MV Agusta's first in the senior class. In this Surtees was assisted by the FIM's decision to ban the defending champion, Geoff Duke, for six months because of his support for a riders' strike for more starting money. In the 1957 season, the MV Agustas were no match for the Gileras and Surtees battled to a third-place finish aboard a 1957 MV Agusta 500 Quattro.

When Gilera and Moto Guzzi withdrew from Grand Prix racing at the end of 1957, Surtees and MV Agusta went on to dominate the competition in the two larger displacement classes – 350cc and 500cc – accumulating seven two-wheeled World Champion titles in all. In 1958, 1959 and 1960, he won 32 out of 39 races and became the first man to win the Senior TT at the Isle of Man TT three years in succession.

1
Born into motor-cycle racing and engineering - John Surtees was schooled in a tough world by dealer/racer father Jack...
© Mortons Archive

2 (Main)
World-class superstar rider flying high on the Isle of Man - John Surtees contested 15 TT races and finished in all except the 1956 Junior. On his works MV Agustas he won the 1956 Senior TT, the 1958 and 1959 Junior and Senior TTs and finally the 1960 Senior. © Mortons Archive





In the winter of 1959-60, while he was still contracted to MV, John was taken under the wing of Reg Parnell, the Aston Martin Team Manager, and of Tony Vandervell, the industrialist, to test Aston Martins and a front-engined Vanwall Grand Prix car at Goodwood.

The point of the exercise was to learn how to handle a racing car while making his mistakes in private. "I had no way of knowing where the limit was, of knowing how fast I should be going", he recalled. "I reached the point where the car wouldn't corner any faster, and would spin off!". In his hands that point was nearly two seconds inside the unofficial lap record.

Ken Tyrrell then entered a brand-new Formula Junior Cooper-BMC for John to drive in the opening BARC Member's Goodwood meeting of 1960. It was actually the first motor race the multiple motor-cycle World Champion had ever watched throughout, although his vantage point was over the windscreen of the unpainted Tyrrell Cooper...

He immediately finished second, beaten only by Jim Clark's works Lotus 18. Colin Chapman was intrigued by Surtees's obvious promise, particularly when he won the Spring Formula 2 race at Oulton Park in a Lotus 18. Sure enough, on May 14 John made his Formula 1 racing debut, at Silverstone, driving a works 18. He would drive for Colin Chapman's team whenever his two-wheeled commitments permitted through the rest of that memorable season, and he staggered the motor racing world by finishing second in the British Grand Prix.

In the Portuguese Grand Prix he started from pole position and led before crashing mildly. In what he described as "my ignorance at the time" he was pushing both himself and his car to discover how both would react to this strange form of racing. Sometimes he would find himself committed to situations which even his lightning reflexes were not up to retrieving. He had a series of spins, crashes and collisions, which made other established drivers eye him with considerable suspicion and wariness. For a period he was viewed as 'The Wild Man', to be avoided...

In 1961 he abandoned motor-cycle racing to concentrate totally upon cars, but his Yeoman Credit/Bowmaker Team Coopers proved sub-standard, and after two early minor wins he accumulated only four World Championship points. He tied with Jack Brabham, but remained deeply dissatisfied — having achieved less than in his novice season of 1960.

He wanted a car of his own which he could test and co-develop. Reg Parnell managed the Bowmaker team, which was then built around Surtees for 1962, while Eric Broadley of Lola Cars built a spaceframe chassis to accept a Coventry Climax V8 engine. Effectively co-engineered by Broadley and Surtees, by mid-season '62 the combination became a regular front-runner.

The operation did much to fulfil this rather introspective, naturally somewhat suspicious sportsman's sense of independence. But fourth place in the World Championship was still far from good enough and Mr Ferrari invited him to visit Maranello 'to talk'.

3
Goodwood opening Members'
Meeting 1960 - Surtees
in his first four-wheeled race in
Tyrell Cooper-BMC Formula
Junior - finished 2nd - to Jim
Clark's Lotus.
© GPL

4 (Main)
1962 Goodwood TT - Surtees
leading in the Ferrari 250GTO.
© GPL





6

5 (Main)
The Old Station Hairpin,
1963 Monaco GP - John in his
works Ferrari 156 V6 leading
Graham Hill's BRM P578.
© GPL

6
John Surtees with the Ferrari -
1964 German GP going out
to qualify...
© GPL

7
John flying high at the
Nurburgring in his Drivers' World
Championship-winning season
with Ferrari - 1964.
© GPL

8
Thoughtful Ferrari pairing on the
pit counter at Le Mans - John with
his ill-fated but very likeable Italian
team-mate, Lorenzo Bandini.
© GPL

9
John was a fine engineer and
always kept a watchful eye upon
everything being done to the
motor-cycle and cars that he
raced. This is typical - practice
scene at Spa-Francorchamps
before the 1964 Belgian GP.
© GPL



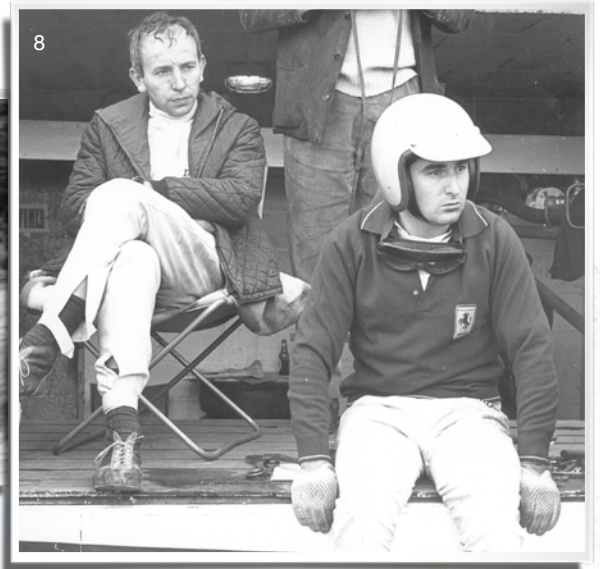

'The Old Man' had greatly admired Surtees in his Championship years with MV-Agusta. He had always had a soft spot for Englishmen, and for motor-cycle-trained racing drivers such as Nuvolari, Varzi and the pre-war Auto Union star Bernd Rosemeyer. Now John Surtees agreed to make the move and became Ferrari's *numero uno* on a three-year contract from 1963-65. He was to work among Italians once more, in a culture and society he greatly enjoyed.

His first Formula 1 World Championship-level success came with victory in the German Grand Prix at the Nurburgring, while he also won non-Championship Formula 1 events at Enna in Sicily and Kyalami in South Africa. There was also success in a whole gaggle of sports car endurance classics. Determined, cool and sensitive — always displaying his high degree of mechanical understanding and touch — Surtees's driving had matured immensely since his 'wild man' days of 1960-61.

He in turn helped Ferrari's new Chief Engineer, Mauro Forghieri, to revolutionise Maranello's technology, bringing to Ferrari his knowledge of the latest state-of-the-art chassis engineering, suspension geometry and general good practise.

With new V8-engined cars in 1964, John Surtees absolutely rose to the occasion. He absolutely excelled in the second half of that season, and stole the World Championship from Graham Hill and Jim Clark on the last lap of the last race — the Mexican Grand Prix in Mexico City.

At this stage in the game the new World Champion enjoyed a tremendous reputation as a tough and formidable competitor, and as a painstaking and intensely committed test and development driver. His utter dedication both at the wheel and behind the scenes was paying off.

10 (Main)

"Best behaviour boys - The Old Man's here..." - John concentrates on the job in hand under the watchful gaze of Enzo Ferrari during the living legend motor manufacturer's annual visit to the Monza pits on Italian GP weekend... Driver team-mate Ludovico Scarfiotti in pale shirt.

© GPL





10

But, during 1965, pressures began to mount within Ferrari. The team manager, Eugenio Dragoni, was a manipulative man who regarded Surtees as a foreign hired gun and greatly favoured his own protégé Lorenzo Bandini. Dragoni saw himself as the man who would recreate the glory days of Italian motor racing, when an Italian driver had carried Ferrari to top honours.

Surtees, in the meantime, had maintained close contact with Eric Broadley and with Lola Cars. The introduction of a new, unlimited-capacity, Group 7 sports-racing class in the United Kingdom attracted his attention for a new enterprise — Team Surtees — which would run V8-engined Lola T70s in races in which Ferrari had no interest. He also drove the Midland Racing Partnership's quasi-works Lola Formula 2 single-seaters and, despite John's unusually warm and close personal relationship with Mr Ferrari, his extra-curricular activities did not sit well at Maranello.

John could — and did — argue forcefully that the Lola activities kept him absolutely up-to-date with motor racing's cutting edge, especially in all-important tyre technology where the big Lolas ran the rapidly improving rubber from Firestone. But as far as Mr Ferrari was concerned, his number one driver should not be risking injury in someone else's cars. At the Canadian Mosport track in 1965 John was badly hurt when his Lola T70 somersaulted after a component failure, and his place at Ferrari for 1966 appeared seriously threatened.

11

John centre of the action - of course - this time in the Ferrari works team garage HQ at Le Mans during the 1965 24-Hour race weekend with the Ferrari 330P2 cars.
© GPL



11



But he staged a near-miraculous recovery to win again for them in a rain-swept Monza 1,000Kms on April 25. The new 3-litre V12 Ferrari was the first of the new Formula 1 batch to appear that year and John won brilliantly, despite pouring rain, at Spa. But irreconcilable differences — essentially with Dragoni — became impossible to tolerate further — and Surtees left Ferrari, abruptly, at Le Mans. BP arranged an alternative drive for him, with Cooper-Maserati, and he shone in their thirsty V12 Formula 1 cars at Reims before rounding off a turbulent season with victory for Cooper-Maserati in the closing race in Mexico.

As a racing motor-cyclist, John Surtees had been immensely impressed by Honda's rise to fame and glory on two wheels, and for 1967 the Japanese company snapped up his services. Their equipment failed him on a consistent basis until the Italian Grand Prix, where his Indy Lola-chassised 'Hondola' won an epic race.

Ferrari's nose was badly put out of joint on home territory, but the Monza *tifosi* still went wild with enthusiastic joy on Surtees's behalf. Not for Honda, mind, but for 'Il Grande John'. They simply loved him.

Honda Racing was very much a Surtees operation, based in Slough, Buckinghamshire, and run totally by the man himself. Never a man to delegate anything he felt he could handle better himself, his increasing involvement with all the minutiae of administration, transport, bookings, as well as design, development and driving to some seemed more often to foil than to promote his expectations.

Honda opted out of Formula 1 at the end of 1968, and while Team Surtees proceeded with development and manufacture of a Len Terry-designed series of Formula 5000 single-seater cars, John himself signed-on with BRM for Formula 1

If ever a team needed Surtees's skills as a 'team doctor' it was BRM. But his abrasive, demanding style clashed almost instantly with that of the staff — both senior and junior — at Bourne. The season became a clear case of oil and water absolutely failing to mix. He was rightly outraged, and initially dismayed, by BRM's working practises, and secondly by a series of stupid, life threatening, car failures.

They, in turn, quickly became appalled at what they saw as his arrogant, dismissive nature. The result was an appalling season in Formula 1, exacerbated by a further bad experience with Jim Hall's radical CanAm Chaparral 'banana' car. Against this background Team Surtees itself represented a haven where the former World Champion could be as much Chairman, Managing Director, driver, administrator, designer, works manager, even mechanic as he could possibly wish.



12
Aviating two wheels on Paddock Hill Bend at Brands Hatch during the 1965 Race of Champions. John always extracted the very last drop of performance from his works Ferraris.
© GPL

13 (Main)
John's magnificent drive in the hastily-built Formula 1 'Hondola' won him the 1967 Italian GP at Monza. The Surtees-loving *tifosi* - who remembered his glory days with MV-Agusta and Ferrari just went wild...
© GPL





14



15





14
John Surtees as driver/
constructor followed in the
Formula 1 wheel-tracks of Jack
Brabham, Bruce McLaren and
Dan Gurney - here making
his debut in his first prototype
Formula 1 Surtees-Cosworth
TS7 - 1970 British GP at
Brands Hatch. © GPL

15
John was borne down in many
ways by the multiple stresses
of running his Team Surtees
operation... Here he is at home
in the paddock at the British GP.
© GPL

16
A picture for John to be proud
of - the Team Surtees line-up
for another Formula 1 World
Championship Grand Prix. ©
GPL

17 (Main)
Last hurrah - John in his swan
song Formula 1 race, waving on
Jackie Stewart's Tyrrell during the
1972 Italian GP at his beloved
Monza Autodrome. © GPL



In 1970 he took Team Surtees into Formula 1, campaigning the McLaren M7C bought from Bruce until his own new Surtees-Cosworth TS7 car could make its debut for the British Grand Prix at Brands Hatch. He used this car and its successors — designed very much under his own direction — to win two Oulton Park Gold Cup Formula 1 races, although Grand Prix success itself remained elusive. By 1972 John began to phase himself out of driving, making a single appearance in the Italian Grand Prix essentially to 'race-develop' his latest TS14 FI design.

By that time he had others driving for him, although he still tested and developed the cars himself.

His fellow multiple motor-cycle World Champion, Mike Hailwood, had shone in Team Surtees Formula 5000 and Formula 2 cars, and now led the Surtees Formula 1 team before moving to McLaren in 1974. But as sponsorship requirements and overall funding became ever more critical — and ever harder to find and to maintain — so 'Il Grande John's' foothold in major-league motor racing became increasingly insecure. Ultimately, at the end of the 1978 season, he closed down his racing operations and the Surtees name left the Formula 1 scene which it had graced so nobly for 19 frenetic, intensely committed, years.

And through every one of those years — in the garage back home in his magnificent Kentish country house — the multiple World Champion had conserved, preserved, and maintained his much-loved part-present from Count Domenico Agusta for having won that 1956 500cc Motor-Cycle World Championship — his BMW 507 as now offered here.



BMW 507 - THE BACKGROUND STORY

The gloriously handsome BMW 507 Coupe was initially the brainchild of American car importer Max Hoffman who, in 1954, persuaded the BMW management to produce a roadster version of the BMW 501 and BMW 502 saloons. His idea was to plug the contemporary gap between the expensive German Mercedes-Benz 300SL and the cheap and really underpowered British Triumph and MG sports cars.

BMW engineer Fritz Fiedler – of pre-war BMW 328 fame - was assigned to design the rolling chassis, using existing components wherever possible. Early body designs by Veritas-BMW high-performance car specialist Ernst Loof were rejected by Hoffman, who found them to unattractive. In November 1954, largely at Hoffman's insistence, BMW contracted instead generalist industrial designer Albrecht von Goertz to style both the BMW 503 and the top-end 507.

Count Albrecht Graf von Schlitz genannt von Goertz von Wisberg had been born on 12 January 1914 in Brunkensen in Lower Saxony. He was the second of three children and while Albrecht did not technically inherit the family title upon his elder brother's premature death, he began to call himself 'The Count', and would often be referred to as such...

He was apprenticed to Deutsche Bank in Hamburg and then to the private bank company of Herbert Wagg & Co in London, but his prospects did not prosper, so in 1936 he emigrated to the USA, settling in Los Angeles where he worked at a car wash and in an aero engine factory. In 1938 Goertz rented a garage and showroom. He restyled and modified Ford Model A and B cars and upon a Mercury chassis, he built a two-door coupe entitled the 'Paragon' which was exhibited to considerable acclaim at the 1939 World Fair Exhibition in New York in 1939.

After five years of wartime service with the US Army, Goertz drove the 'Paragon' to New York and while driving it accidentally encountered Raymond Loewy, the leading automotive stylist. Loewy invited Goertz to his office, sent him to college to study formal design and later gave him a job in the Studebaker studio in Indiana...

In 1953 Goertz set up his own design consultancy and met Max Hoffman, BMW's leading importer into America. Hoffman knew of BMW's plans to build a sports car and suggested that Goertz should contact BMW in Munich. Discussions went well – particularly when Goertz's sketches were studied in comparison to Loof's – and Goertz was then engaged to design both the BMW 503 and the BMW 507, initially for the 1955 model year but extending in the case of the 507 into 1956.

We understand that 34 Series I BMW 507s were built in 1956 and early 1957. These vehicles featured 110-litre (29.1 US gallon) competition-style welded aluminium fuel tanks installed behind the rear seats. These large tanks limited both boot and passenger space, and left the cars' cabin space smelling of petrol when the hood was erected or the hardtop fitted. In consequence, Series II and later 507s had 66-litre (17.4 US gal) fuel tanks carried underneath the boot, shaped around a space to accommodate the spare tyre.

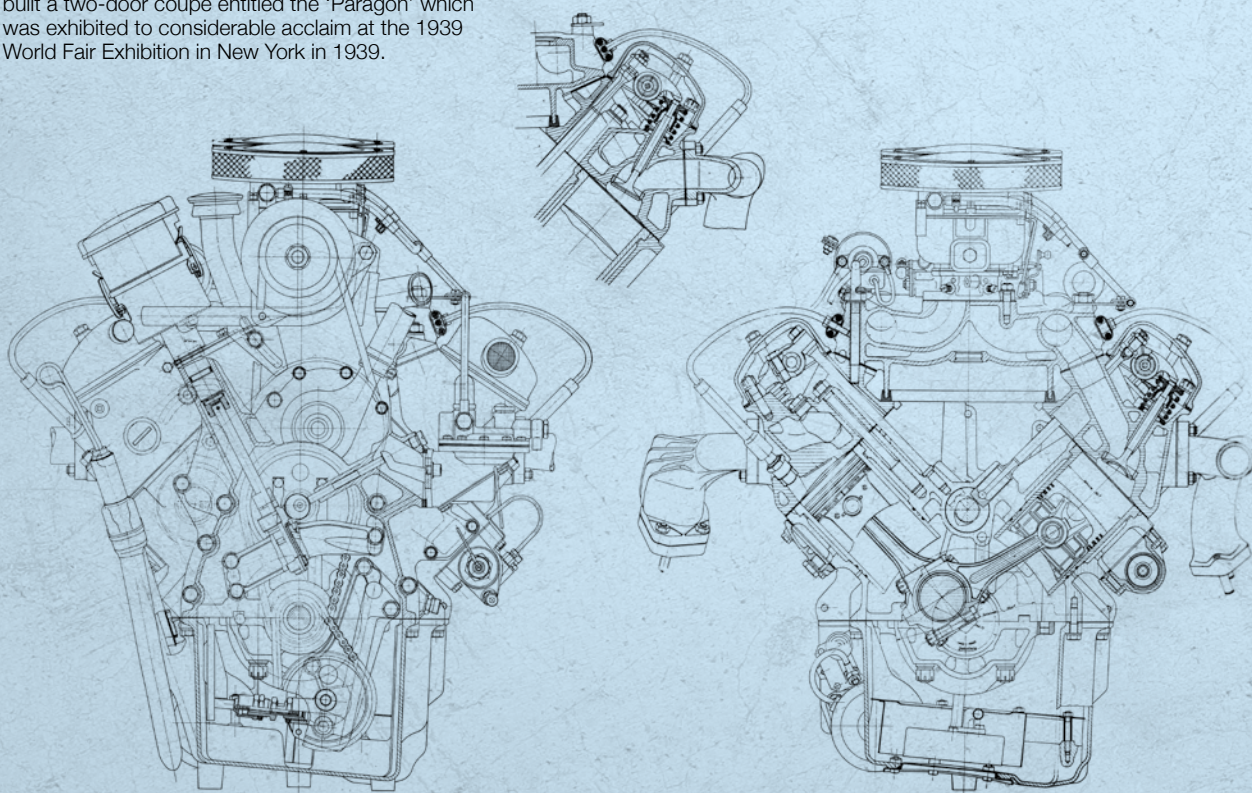

TECHNICALITIES

The 507 Coupe was based upon a shortened *Typ 503* chassis frame, providing a wheelbase length reduced from 2,835mm (111.6 inches) to 2,480mm (98 inches). The Coupe's overall length was 4,835 mm (190.4 inches), and overall height 1,257mm (49.5 in).

Kerb weight was a claimed 1,330 kilograms (2,930lbs). The exceptionally shapely and fluid bodywork was almost entirely panelled in hand-formed aluminium sheet, and every individual 507 Coupe issued from the factory as an individual, no two were precisely the same...

Eleven of the cars were sold with an optional hand-fabricated removable hardtop, and again - as befits bespoke hand-made tailoring - each hardtop fitted only the individual car for which it had been made.

Front suspension was by parallel double wishbones while the rear suspension featured a live axle. Springing was by torsion bars front and rear, and there was an anti-roll bar provided at the front while the live back axle was firmly located by a Panhard rod and a central, lateral A-arm to resist acceleration and braking forces.

Brakes - as standard - were Alfin drum type - 284.5mm (11.2 inches) in diameter, with optional power assistance. Late-model 507s were eventually fitted with British-made Girling disc brakes at the front. The John Surtees car as offered here actually features disc brakes all round, front and rear as explained in the main text.

The 507 Coupe's power unit was a BMW aluminium-alloy pushrod-operated overhead-valve V8 unit, displacing 3,168 cc (193.3 cubic inches). It breathed through two Zenith 32NDIX two-barrel carburettors, and featured a chain-driven oil pump, high-lift cams, a returned spark advance curve compared to the associated saloon models, polished combustion chambers, and a compression ratio of 7.8:1. Power output was claimed to be 150 metric horsepower (110 kW) DIN at 5,000rpm. This impressive-looking - and sounding - power unit was mated to a close-ratio four-speed manual transmission. The standard final-drive ratio was selected as 3.70:1, with gear-sets offering 3.42:1 and 3.90:1 optional.

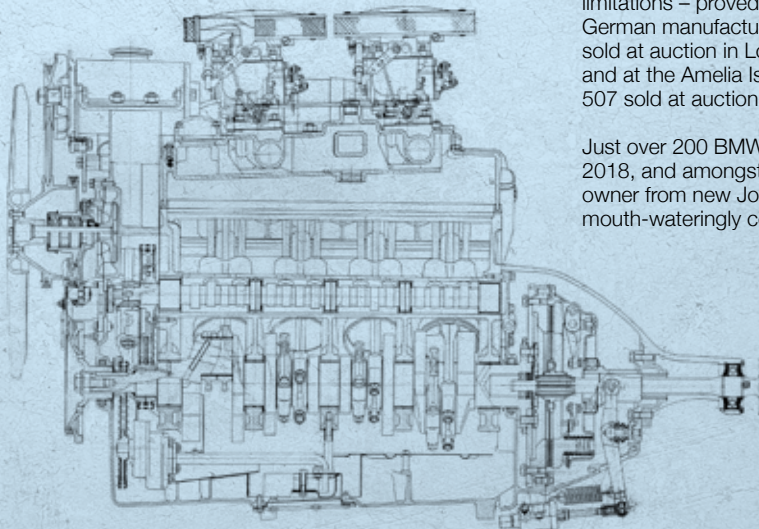

A contemporary road test of a BMW 507 with the standard 3.70:1 final drive appeared in the Swiss magazine *'Motor Revue'*, citing 0-100 km/h (0-62 mph) acceleration in 11.1 seconds and a top speed of 122mph... heady figures for 1956-57 - here indeed was a rocket ship for the public road...

The brand-new BMW 507 made its debut at the Waldorf-Astoria Hotel in New York in the summer of 1955 and production began in November 1956. Max Hoffman intended the 507 to sell for some US \$5,000, which he believed would support a Munich production run of 5,000 units a year. However, production costs of this svelte new German beauty ran away with the project, and the German market price inflated relentlessly - first to DM 26,500 and later 29,950) which punched the US market price initially to \$9,000 then \$10,500.

The 507 Spyder and Coupe's undoubtedly startling looks attracted such celebrity customers as Elvis Presley (who owned two), and Hollywood movie director John Derek, while in Germany pre-war Grand Prix racing Champion Hans Stuck and motor-cycling star Georg 'Schorsch' Meier became prominent owners.

Despite having been conceived to revive BMW's sporting image, and to drive brand-perception and sales volume forward, the 507 V8 failed to attract more than 10 per cent of the sales volumes enjoyed by its Stuttgart rival, the six cylinder Mercedes-Benz 300SL. Yet for many it was an infinitely better-looking, more glamorous, lighter handling - and rapid - alternative.

Their sales difficulties with the 507 instead took BMW to the edge of bankruptcy. In 1959 the Munich company's losses reached DM 15-million. The company lost money on every 507 built, and when production was abandoned late in 1959 only 252 individual 507s had been completed, plus two prototypes. Fortunately for the Bavarian company, an infusion of capital from Herbert Quandt and the launch of new, cheaper models (the BMW 700 and later the 'New Class' 1500) looking at a very different sector of the road car market, helped the company recover and indeed placed it upon the launching pad to legendary and in many ways world-leading success.

The BMW 507 - despite its contemporary commercial limitations - proved to be a landmark model for the German manufacturer. As early as 2007 one example sold at auction in London for £430,238 (US \$904,000) and at the Amelia Island *Concours* in March, 2014 a 507 sold at auction for US \$2.4 million.

Just over 200 BMW 507s are known to survive here in 2018, and amongst them all - we are confident - one-owner from new John Surtees example is the most mouth-wateringly covetable.

331

The ex-Team Lotus, Jim Clark/John Whitmore/Jack Sears

1965 FORD LOTUS CORTINA MKI COMPETITION SALOON

Registration no. JTW 498C

Chassis no. BA85E 424567S

- *Original works team car*
- *Well documented history*
- *Professionally restored in the 2000s*
- *Original competition modifications retained*





Ford's 1960s profile-raising competition programme included recruiting Lotus boss Colin Chapman to give the new Cortina a sporting makeover. Chapman's brief was to develop a Group 2 competition version; Lotus would then build the 1,000 cars required for homologation. Launched in 1963, the Lotus Cortina - Cortina Lotus in Ford parlance - featured the Elan's Ford-based, twin-overhead-camshaft, 1.6-litre engine in the two-door bodyshell. McPherson strut independent front suspension was retained, with revised spring and damper rates, while the rear leaf springs were replaced by coil-spring/damper units, axle location being achieved by trailing arms and an 'A' bracket.

The adoption of an alloy differential casing proved a mixed blessing, the lightweight component proving far less oil-tight than the original. Reversion to Ford's standard leaf-sprung axle cured the problem. Lotus Cortinas dominated saloon racing's 2-litre class, often challenging for outright honours. Works cars were driven by Jim Clark, Graham Hill, Peter Arundell and Jackie Ickx, while Sir John Whitmore, driving an Alan Mann-entered Lotus Cortina, was European Touring Car Champion in 1965. After the axle change, the hitherto fragile Lotus Cortina proved a highly capable rally car, works driver Bengt Soderstrom winning the Acropolis and RAC rallies in 1966.

The Lotus Cortina offered here is one of the original works racing saloons campaigned during the mid-1960s by legendary Formula 1 World Champion, Jim Clark, while touring car champions Sir John Whitmore and Jack Sears also competed in this same car. 'JTW 498C' was raced, together with 'JTW 496C' and 'JTW 497C', by the works-backed Team Lotus during 1965 and comes with its factory record card recording events entered, dates, drivers, engines fitted, failures and comments. During 1965, 'JTW 498C' was used in the British saloon car championship, being driven by Jack Sears at Goodwood and Snetterton (twice), Jim Clark at Silverstone and Brands Hatch, and John Whitmore at Oulton Park.

Throughout 1965 'JTW 498C' was owned by the Ford Motor Company, passing into the ownership of Lotus Cars Ltd in 1966 as recorded in the accompanying original old-style logbook. It is believed to have been used as road transport by Team Lotus Chief Mechanic, David Lazenby before being sold into the private ownership of Lotus Components employee, Thomas Kelly, in April 1967. Several succeeding owners are recorded in accompanying documentation compiled by one of them, Mr Richard Coombes, who owned the car in 1984. In 1997 the Lotus was sold to Trevor Barefoot, having been kept in storage for an extended period and with most, if not all, its original modifications still in place.





John Whitmore, Oulton Park, 1965



Pushing through the Goodwood chicane

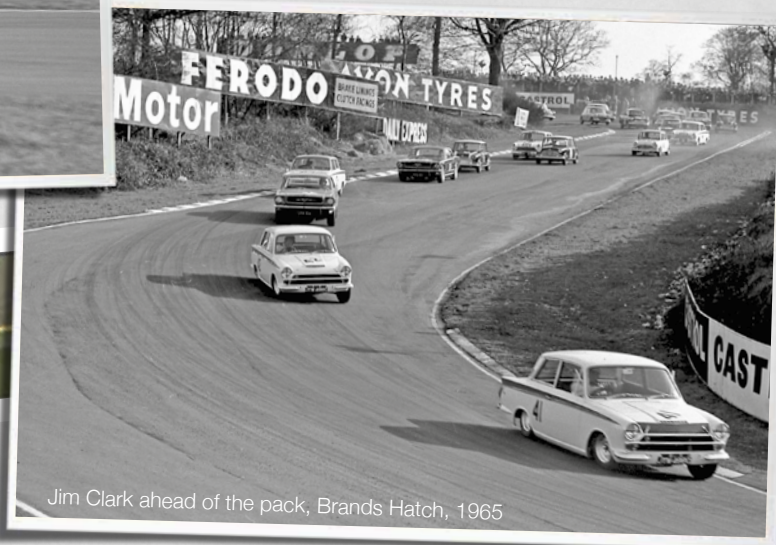

Jim Clark ahead of the pack, Brands Hatch, 1965

— TEAM LOTUS —

'JTW 498C' has since been restored, much of the work being carried out by one of this country's leading Lotus Cortina specialists, Exway Coachworks of Exmouth, Devon with many hundreds of man-hours spent. We are advised that the car underwent a total body restoration during 2003/2004, many panels being replaced and new seats fabricated, exactly replicating those originally fitted during its racing career. Suspension and steering modifications unique to this car have been retained and remain in place, while the engine underwent a total rebuild by recognised specialist Pat Thomas of Kelvedon Motors to bring it back to full race specification at a cost in excess of £14,000. Related bills may be found within the extensive history file, which also contains letters of authentication from the Lotus Cortina Register, a UK V5C Registration Certificate, current MoT, and the aforementioned logbook and race records.

Since its acquisition by the current vendor in 2007, 'JTW 498C' has been used sparingly, its outings being confined to demonstration runs up the hill at the Goodwood Festival of Speed in 2008, 2012, and 2013. A unique opportunity to acquire an historic racing saloon associated with three great motor racing champions, including the legendary Jim Clark.

£200,000 - 250,000
€230,000 - 290,000



332

The ex-Jaguar Demonstrator, 64th production

**1961 JAGUAR E-TYPE SERIES 1 'FLAT FLOOR'
EXTERNAL BONNET LOCK 3.8-LITRE ROADSTER**

Registration no. 655 MYC

Chassis no. 850064

- *One of the earliest surviving right-hand drive roadsters*
- *Delivered new in the UK*
- *Matching chassis, engine, and registration numbers*
- *Meticulously restored by XK Engineering with exacting attention to detail*
- *Concours condition*



Pictured (circled) outside Browns Lane in 1961 prior to dispatch. (image part of lot)



'Here we have one of the quietest and most flexible cars on the market, capable of whispering along in top gear at 10mph or leaping into its 150mph stride on the brief depression of a pedal. A practical touring car, this, with its wide doors and capacious luggage space, yet it has a sheer beauty of line which easily beats the Italians at their own particular game.'

There have been few better summaries of the Jaguar E-Type's manifest virtues than John Bolster's, penned for *Autosport* shortly after the car's debut in 1961. Introduced in 3.8-litre form, the E-Type caused a sensation when it appeared, with instantly classic lines and a 150mph (241km/h) top speed. The newcomer's design owed much to that of the racing D-Type: a monocoque tub forming the main structure, while a tubular spaceframe extended forwards to support the engine. The latter was the same 3.8-litre, triple-carburettor 'S' unit first offered as an option on the preceding XK150. An optimistic 265bhp was claimed, but whatever the installed horsepower, the E-Type's performance did not disappoint; firstly, because it weighed around 500lb (227kg) less than the XK150 and secondly because aerodynamicist Malcolm Sayer used experience gained with the D-Type to create one of the most elegant and efficient shapes ever to grace a motor car. Taller drivers though, could find the interior somewhat lacking in space, a criticism addressed by the introduction of foot wells (and other, more minor, modifications) early in 1962.

But of all the versions of Jaguar's long-lived and much-loved sports car, it is the very early 'flat floor' 3.8-litre cars built prior to February 1962 which, for many enthusiasts, remain the most desirable.

Dating from the first few weeks of production, this stunning example is one of the earliest surviving right-hand drive Jaguar E-Type roadsters (the chassis number sequence commenced at '850001') and was delivered via distributor Henlys to W Sparrow & Sons of Yeovil, Somerset. Chassis number '850064' was despatched by the works on 14th July 1961, was first registered '655 MYC' on 25th August, and used by Sparrow as a demonstrator. The car has features typical of early production models, including the flat floor and teardrop covers for the external bonnet locks.

Inspected by surveyor and valuer, A E Fogg BSC, LLB in December 1990 (copy included), it had been recently taxed for the first time in several years, having been off the road undergoing a total restoration. The vehicle had been extensively refurbished (by marque expert Martin Robey) and was found to be totally rust-free, having been professionally repainted in original Opalescent Silver Blue. All mechanical components had been overhauled, and the car ran very sweetly with good oil pressure and normal running temperature.



All running gear had been overhauled, the only discernible non-original feature being Koni shock absorbers (a period up-grade) and a later production-type radiator. The restoration was unfinished at the time of inspection and was finally completed circa 1992.

Re-inspected by Mr Fogg in March 2005, the car was found to be finished to a very good standard and to have been well maintained, having covered fewer than 8,000 miles in the intervening 14 years. In June 2005, the E-Type was offered for sale at Bonhams' Goodwood Festival of Speed auction (Lot 670), and later that same year passed into the ownership of a 'Mr Anthony', who kept it until 2017 (see email correspondence on file).

The current vendor purchased the E-Type in 2017, since when it has benefited from a 'last-nut-and-bolt' total restoration carried out by renowned marque specialists, XK Engineering at great expense, see bills on file. This painstaking rebuild was only completed in April 2018, and the car is presented in effectively 'brand new' concours condition. Reunited with its original registration mark '655 MYC', this beautiful E-Type comes with the optional works-specification hardtop (unrestored), Jaguar tool roll, restoration invoices, UK V5C registration document, and a Jaguar Daimler Heritage Trust Certificate confirming matching numbers.

£380,000 - 440,000
€430,000 - 500,000



333

1996 PORSCHE 911 TYPE 993 TURBO COUPÉ

Registration no. N259 MCL

Chassis no. WP0ZZZ99ZTS371925

- *Genuine UK-market model*
- *Circa 39,000 miles from new*
- *Fresh MoT*

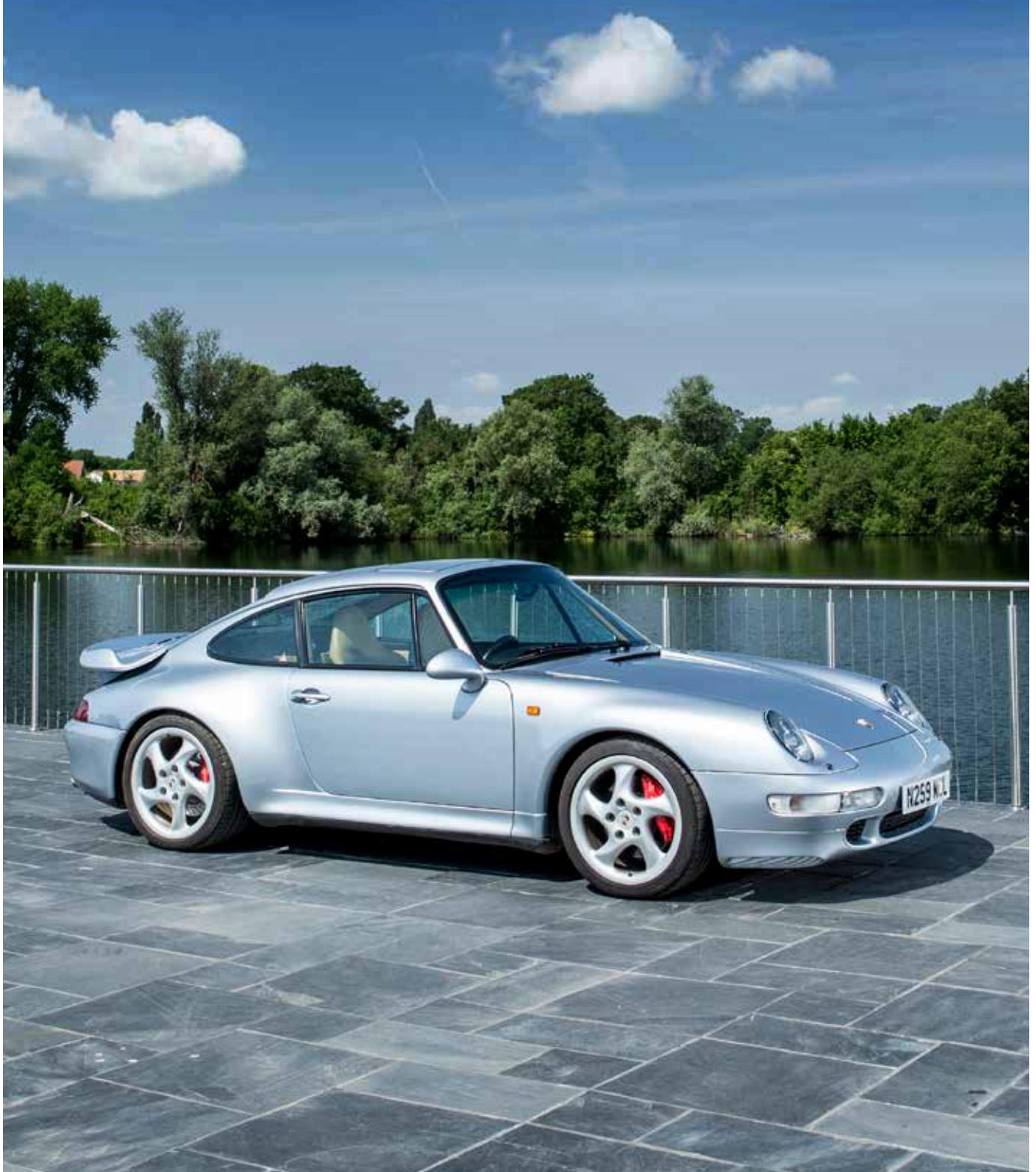



'I have never driven a car capable of going so fast with so little effort. It means you can enjoy the sort of performance that gives you 60mph from rest in under 4.5 seconds, or that will take you from 60mph to 120mph in fifth gear in around 12 seconds, without panic or fluster. You can relax and plan your moves calmly. Overtaking could hardly be easier.' – John Simister on the Porsche 911 Turbo, *Car* magazine, June 1995.

In 1993 Porsche introduced what is regarded by many as the most beautiful 911 of all: the Type 993. Over the years the 911 had received numerous aerodynamic and safety-inspired add-ons, diluting the purity of the original form; the Type 993's arrival marked a return to basic principles, being recognisably a 911 but one in which all functions had been harmoniously integrated in a truly outstanding example of modern automotive styling. The range offered remained pretty much as before, comprising two- and four-wheel drive models, the Turbo and Cabriolet convertible, all powered by the latest, 3.6-litre version of Porsche's perennial flat-six engine.

Top of the 911 range, as ever, was the legendary Turbo, in Type 993 guise featuring the new four-wheel-drive transmission. Equipped with twin KKK turbochargers, the engine developed a staggering 408bhp, which was transmitted to the road via a six-speed manual gearbox. The result was a top speed of 290km/h (180mph) and a 0-100km/h (62mph) time of under five seconds.

Equally impressive were the anti-lock brakes, Porsche claiming a figure of only 2.6 seconds to stop from 100km/h. And if that was still not enough, customers could specify the 'X-50' performance package - also known as the 'Powerkit' - that lifted maximum engine output to 430bhp.

Unfortunately, this Porsche 911 Turbo's service history has been mislaid; however, Bonhams has obtained a summary of its services from Porsche Colchester. This document lists 12 routine and other services between March 1996 and February 2003, with a further service in December 2016 making 13 in all. The car's accompanying Vehicle Information sheet reveals that it was built for the UK market and fitted with the following options: heated sports seats, recoil bumpers, top-tinted windscreen, sunroof, leather airbag steering wheel, and sun visors in leather. Finished in silver with tan leather interior, the car has covered circa 39,000 miles from new and is described by the vendor as in generally very good condition. Offered with a V5C document and fresh MoT.

£90,000 - 110,000
€100,000 - 120,000

For details of the charges payable in addition to the final Hammer Price of each Lot please refer to paragraphs 7 & 8 of the Notice to Bidders at the back of the catalogue.

334

Property of a deceased's estate

**1972 FERRARI DINO 246GT
BERLINETTA PROJECT**

Coachwork by Pininfarina/Scaglietti

Registration no. not UK registered

Chassis no. 05328

- *Original European-specification example*
- *Delivered new in Italy*
- *Stored for circa 35 years*
- *Replacement engine (rebuilt)*
- *Re-sprayed paintwork*





In the mid-1960s, Ferrari needed a production-based 2.0-litre engine for the new Formula 2 and conceived the mid-engined Dino to provide the necessary basis. The first of these 'junior' Ferraris – the 206GT – debuted at the Turin Motor Show in 1967. A compact, aluminium-bodied coupé of striking appearance, the Pininfarina-styled Dino – named after Enzo Ferrari's late son Alfredo Ferrari and intended as the first of a separate but related marque – was powered by a four-cam V6 engine, mounted transversely and driving through an in-unit five-speed transaxle. The motor's 180bhp was good enough to propel the lightweight, aerodynamically-efficient Dino to 142mph, and while there were few complaints about its performance, the high cost enforced by its aluminium construction hindered sales.

A 2.4-litre version on a longer wheelbase – the 246GT – replaced the Dino 206 in late 1969. The body was now steel and the cylinder block cast-iron rather than aluminium, but the bigger engine's increased power – 195bhp at 7,600rpm – was more than adequate compensation for the weight gain. Top speed increase slightly to within a whisker of 150mph. While not as fast in a straight line as its larger V12-engined stablemates, the nimble Dino was capable of showing almost anything a clean pair of heels over twisty going. Truly a driver's car par excellence.

Originally finished in Giallo Fly (yellow) with black vinyl interior, this left-hand drive, European-specification Dino 246GT was delivered new in Rome, Italy in December 1972 to the official Ferrari dealership, Carla Allegretti & Co. Its first owner was one Mario Coratti, a resident of Monte San Giovanni Campano in the Province of Frosinone, Italy. The Ferrari had two further owners in Frosinone: Sergio Perna and Vittorio di Giampietro, before being sold in 1976 to Giovanni Gagliardi, resident in Rome.

The Dino was acquired by the late owner in the early 1980s. Some time later, the car was fitted with a replacement engine, which had been rebuilt and dynamometer tested, and was in full working order when installed. In addition, the paintwork was re-sprayed. The car has sat in a Midlands lockup garage for the last 35-or-so years and will require a certain amount of re-commissioning before returning to the road. There is no registration document with this Lot, which comes with a Massini report and is sold strictly as viewed.

£100,000 - 130,000
€120,000 - 170,000

335

'2 VEV' - *The ex-Essex Racing Stable*

**1961-62 ASTON MARTIN 'MP209' DB4GT ZAGATO
GRAND TOURING TWO-SEAT COUPE**

Registration no. 2 VEV

Chassis no. DB4GT/0183/R



- One of the two legendary 'VEV' Zagatos campaigned by works-backed Essex Racing Stable
- Factory-prepared and raced in period 1961-62 as a quasi-works team car
- International period race history including Le Mans and Goodwood TT
- Iconic Anglo-Italian Berlinetta driven so spectacularly in 1961-1962 by double-Formula 1 World Champion and Indy '500' winning superstar Jim Clark
- Aston Martin's Ferrari 250 GTO
- Built upon the prototype for Aston Martin's forthcoming Project 214 chassis frame
- Single-family ownership since 1971 - some 47 years
- The most prominent and charismatic of only 19 Aston Martin DB4GT Zagatos
- In greater detail - the most prominent of the creme-de-la-creme batch of only three 'MP209' specification 'Super Lightweight' Zagatos constructed
- A worthy figurehead of any collection and a golden key to the world's finest premier events





2

1 (Main)
 New-born twin sisters - Le Mans 1961 -
 '1 VEV' and '2 VEV' in the Essex Racing Stable
 team's corner of the paddock.
 © Photo Brian Joscelyne

2
 In echelon before the Monthéry pits - the
 Essex Racing Stables' works-backed Aston
 Martin entries of '1 VEV' - No 15 - for
 Jim Clark/Innes Ireland - and '2 VEV'
 - No 16 - for Tony Maggs/Sir John Whitmore.
 © Photo Brian Joscelyne

3
 '2 VEV' is returned to the paddock at the
 Autodrome du Linas-Monthéry during the Paris
 1,000Kms race weekend in October, 1961.
 Co-driven by Tony Maggs/Sir John Whitmore.
 © Photo Brian Joscelyne





BONHAMS is delighted to offer this ultimate, individual Aston Martin Zagato to the car-collecting world, fresh from no fewer than 47 loving years in just one particularly long-term (and adoring) family ownership. This competition coupe – always known by its distinctive UK road-registration number ‘2 VEV’ - is simply the best-known and most charismatic of all Aston Martin DB4GT Zagatos.

But this ultimate Zagato variant, the 1962 ‘Manage Project 209’, was essentially a development prototype – sharing a near-identical new chassis structure to the DP214 works-run ‘Project car’ design then forthcoming for the Aston Martin factory team’s revival in 1963. While there were 19 Aston Martin DB4GT Zagato entities manufactured overall, only three of them were to this ultimate ‘MP 209’ specification – known internally at the Feltham factory as the ‘Super Lightweight’ or ‘GTSL’.

Of all those 19 Aston Martin DB4GT Zagato identities manufactured through 1960-62 – the renowned ‘British Berlinettas’ – ‘2 VEV’ is indeed the most well-known...especially for its contemporary appearances in the hands of one of the greatest – and truly most revered - racing drivers that the motor sporting world has ever seen

As new, ‘2 VEV’ as offered here was driven by legendary double-Formula 1 World Champion Driver – and Indianapolis 500-Miles classic winner - Jim Clark in the RAC Tourist Trophy at Goodwood and in the Paris 1,000 Kilometres at Montlhery. In Jimmy’s supremely talented hands this is the car which starred on that Tourist Trophy stage as both the most spectacular looking – and sounding – car on course. This was in part because the ‘MP209’ Zagato had not at that stage been fully developed and its handling demanded a driver of Jimmy Clark’s stupendous natural talents to extract its ultimate lap-time potential. This he did in spectacular, grandstand-pleasing style...until on lap 60 of the 100-lap, 1962 Goodwood TT, even the brilliantly gifted Scottish superstar’s precocious skills were not quite enough to keep ‘2 VEV’ in hand, immediately after having just left the pits on cold tyres.....

So here we offer perhaps the most famous – and certainly the most covetable – of the Aston Martin quasi-works team’s competition coupes from the early 1960s. The Aston Martin racing heritage from the 1920s forward was built largely by corinthian-minded sporting gentry with an enduring interest in motor racing, in fine high-performance sports and GT racing cars, and enjoying the disposable wealth to indulge their enthusiasm.

Such a heritage is entirely in keeping with the parallel story of the Goodwood Motor Circuit – very much ‘The Best of British’ – and we at BONHAMS are extremely proud of our founding status with Goodwood Motorsport, and the pioneering Festival of Speed. The circuit itself was the deceptively difficult and demanding stage upon which the great, world-class RAC Tourist Trophy races were run from 1958 to 1964, and it was right here – in the 1959 TT – that the quintessentially-British Aston Martin works team clinched the FIA Sports Car World Championship title.

That was, however, the last year of the official FIA Sports Car World Championship competition. From 1960 the International governing body shifted its endurance racing focus to the closed-cabin world of Grand Touring cars – including this magnificent Aston Martin DB4GT Zagato Coupe, ‘2 VEV’.

But through 1961-62 the marque’s involvement featured no formal works team participation. Instead, Aston Martin’s fortunes – and where many enthusiasts were concerned the honour of the British high-performance car industry – was upheld by a quasi-works private team. And that team was enthusiast entrant John Ogier’s ‘Essex Racing Stable’ operation, based originally within a stable block at his home in East Hanningfield, near Chelmsford in Essex.

The background to this was that David Brown’s Aston Martin factory had split its works team operation in 1959 to compete in both the sports car and Formula 1 World Championship race series, before – in 1960 it focused entirely upon the single-seater Grand Prix class – without conspicuous success for what had become its long-delayed and therefore outdated front-engined Formula 1 car design.

This shortcoming persuaded David Brown finally to withdraw from full-time works racing team participation for 1961-62. To fill the gap, he and his legendary racing manager John Wyer encouraged marque-enthusiast John Ogier to campaign one ex-works DBR1 sports-racing car, plus the 1960 'Lightweight' DB4GT Coupes' 17 TVX' and '18 TVX'. And in 1961 these twin DB4GTs were supplemented by a pair of brand-new Aston Martin DB4GT Zagato Coupes – enabling Ogier's Essex Racing Stable to field Feltham's latest and finest on the factory's behalf.

And it was right here at Goodwood – in the 1961 and 1962 TT races – that the Essex Racing Stable-entered Aston Martin Zagatos then provided a sensational sight as the spectacular-to-watch, glorious-to-hear, home-industry banner wavers defending British prestige against what was genuinely an invasion fleet of V12-engined Italian Ferrari 250 GT SWBs and later GTOs.

Back in 1940 Goodwood - as the Royal Air Force fighter aerodrome it then was - had been right in the forefront of the Battle of Britain. From its grass runways the contemporary best of British engineering had been the Spitfire and Hurricane fighter aircraft defending the democratic way of life. By 1961-62 in those RAC TT races, the best of British engineering was provided here at Goodwood by John Ogier's quasi-works team Aston Martin Zagatos, spearheaded by the 1962 iteration of '2 VEV' in its ultimate, virtual 'Project car' specification, the 'MP 209'.

The background to Ogier's DB4GT Zagato cars – so distinctively UK road registered as '1 VEV' and '2 VEV' from new in 1961 – was that these factory-prepared Aston Martins were first fielded by Ogier's Essex Racing Stable team in that year's Le Mans 24-Hour race - '1 VEV' to be co-driven by Jack Fairman/ Bernard Consten and '2 VEV' by highly-experienced Australian stars Lex Davison and Bib Stilwell. Sadly, both the brand-new cars simply overheated into retirement due to a preparation failure; the engine cylinder heads had not been torqued-down sufficiently after initial running of the freshly-built power units...





4



4
The great Jim Clark clips the apex whilst holding a perfectly balanced four wheel drift..... © GPL

5 (Main)
'2 VEV' being hurled through St Mary's corner during the 1961 Goodwood TT. Driven by Jim Clark the Aston Zagatos were always the most spectacular cars in the TT field. © GPL

6
Speedy tyre change and refuel please - '2 VEV' in the Goodwood TT pits 1961. © GPL



5

But the preceding failure of the twin British entered 'VEV' cars left devastated team owner John Ogier – who had just paid Aston Martin £8,762 for the two Zagatos (at 20 per cent discount) - absolutely furious with the factory. An ex-military man, Ogier was an immensely successful businessman and a perfectionist in all his endeavours – and he could not accept such embarrassing disappointment. Where both his cars had failed within the first 90-minutes at Le Mans, the sister French-entered DB4 GT Zagato of Jean Kerguen/'Franc' had run well for 23 hours before Lucas starter motor failure had ended its chances. Its works mechanic Des O'Dell had ensured he torqued-down the engine's cylinder-head studs after each run – someone had apparently thought that such pernickety attention was unnecessary....

But motor sport marches on, and at Aintree for the 1961 British Grand Prix meeting on July 15, Australian veteran Lex Davison drove '2 VEV' in the important 17-lap supporting GT race – and the combination won in spectacular style – catching and passing Jack Sears' Jaguar E-Type on the very last lap. Ogier's post-Le Mans anger was much mollified by this high-profile victory, second time out for '2 VEV'.

In the major Goodwood TT on August 19, his twin Zagatos were then entrusted to Formula 1 stars Roy Salvadori and Jim Clark – who was then the meteorically fast-developing future Team Lotus star. It was then that the two 'VEV's were cast as the muscle-bound Anglo-Italian underdogs, defending British honour against a horde of 3-litre V12 Ferrari 250 GT SWBs.

6





STEPHEN ARCHER – AN APPRECIATION OF THE MP209 ZAGATO

In the process of researching a book there is usually a golden nugget to be found. During research for the Palawan Zagato book 22 years ago, the emergence of the full 'MP209' Project Zagato story was that exciting nugget. Until then, no one had stopped to really look at the three cars to consider just how special they are under the skin. Certainly the difference in these cars from standard is profound.

"No two Zagatos are the same" goes the refrain but this is only true up to a point. Most of the cars have 'had a life' and had some restoration at various stages leading to individuality increasing with the passing of time. In truth, there are really only three 'standard' designs of DB4GT Zagato. The most obviously distinctive types are the MP209 cars but just how and why are they so distinctive?

In 1961 it was clear to Aston Martin that to take on Ferrari some weight would need to be removed from the standard Zagato. The design team under Ted Cutting set to work on creating a new chassis that ditched the platform design of the DB4GT and instead took its strength from box sections. The engine bay was devoid of any steel panel work and light aluminium paneling featured throughout the car where gaps needed filling such as the bulkheads and floor. Quick lift jacking points were standard.

The rear suspension had polished components and telescopic dampers from the outset. The front was also made of race prepared components and had an adjustable roll centre in a way that the DB4GT never could. This was a very track focused chassis and was super light. The thinking for racing bodies back in 1962 was that tails should be high to minimize lift and noses long and low to maximize smooth air penetration. Zagato were given the task of making these changes to the standard design.

The car featured a longer nose; smaller and lower headlight apertures; a wider and lower front grill with the sidelights mounted inside the grill. They also had prominent, large air scoops to feed the oil cooler and front brake ducts. The rear window was many degrees shallower in angle and the tail was higher and a little longer. Door windows were no longer lifting but were Perspex sliding. The interior was purposeful competition style with some Hardura trim but not much else. The original gearboxes had magnesium casings and they even tried a magnesium block but in the end settled for magnesium castings on the engine, which was enlarged to 3.8-litres. The exact same engine as in DP214.

To underline the intent of Aston Martin the three cars were supplied to decent teams. John Coombs in England, Jean Kerguen in France and John Ogier. The MP209 that went to Ogier was almost certainly destined for his hands from early in 1962 but it took the crash of the first 2 VEV for the transaction to be consummated.

It is hard to overstate how special, exciting and beautiful these three MP209 cars are. A combination of the exotic charm of Zagato's design with the pure racing intent from Aston Martin for these cars bestows upon them a unique status. Having driven 2 VEV and numerous Zagatos and GTs; this car stands out as noticeably light, sharp and of quick response. It feels more akin to DP214 than a standard Zagato. It has that poise and single-minded purpose with minimal compromise. It's a car that encourages the driver to push on a bit because it is designed for pace and distance.

It was designed and built to perform a task and its capability says a lot of the skill of the Aston Martin engineers.

I want one!

Stephen Archer
Aston Martin author and historian



WATCH VIDEO ►

<http://www.bonhams.com/video/26058/>



Critically, the very fast and powerful Zagatos demanded four tyre changes during the 3-Hour race, against the Ferraris' three. While Stirling Moss and Michael Parkes finished 1-2 for Ferrari, Roy Salvadori in '1 VEV' and Jim Clark in '2 VEV' came home 3rd and 4th – bettered, but only narrowly – while Ogier's year-older DB4GT '17 TVX' finished 5th driven by Clark's Team Lotus No 1, Innes Ireland...

Innes then drove '2 VEV' into 3rd place in the MolySlip Trophy race at Snetterton, after being delayed by a minor collision, while Tony Maggs/Sir John Whitmore took ninth place in the car in the 1961 Paris 1,000Kms at Montlhéry.

Into Spring, 1962, at the factory's request, Ogier then loaned '2 VEV' to the Belgian Equipe National Belge for Lucien Bianchi to drive in the 15-lap, 211km, Spa Grand Prix. The experienced Belgian was fantastically quick in the car during practice, started from pole and led from the start in the face of massed Ferrari opposition but he then crashed heavily at Les Combes corner, somersaulting over a barrier to fall upside-down into a roadside stone quarry.

While he assured his pit crew the damage wasn't too bad and that he thought the car "might be driveable" after the race, it was in fact adjudged a write-off. It had been fully insured and was actually replaced entirely in July 1962 by the factory with the brand-new 'MP209' specification 'Super Lightweight' '2 VEV' now offered here by Bonhams.

This replacement car's revised Zagato body shape offered improved aerodynamic performance. Its lightweight chassis was a completely redesigned box-section ladder frame. Only three such 'MP209' Zagatos would be built by Aston Martin, each one of them no less than an incredible 507lbs lighter than the standard production DB4GT, and 300lbs lighter than the standard Zagato...

Most significantly, '2 VEV's new 'MP209' chassis would prove to be prototype-work for what would emerge as the revived Aston Martin works team's Project 214 Coupe design for 1963. Much of Project 214's DNA can be traced to this trio of 1962 'MP209' super-lightweight Zagatos and consequently, John Ogier's 1962 '2 VEV' – as now offered here - was actually a far more advanced car than its 1961 predecessor.



7

Goodwood Motor Circuit, April 2018.
The Bonhams team and www.motorcarstudiosltd.com
from Philadelphia had great fun shooting the video for
2 VEV - perhaps none other than James Woods,
who duly performed driving duties.



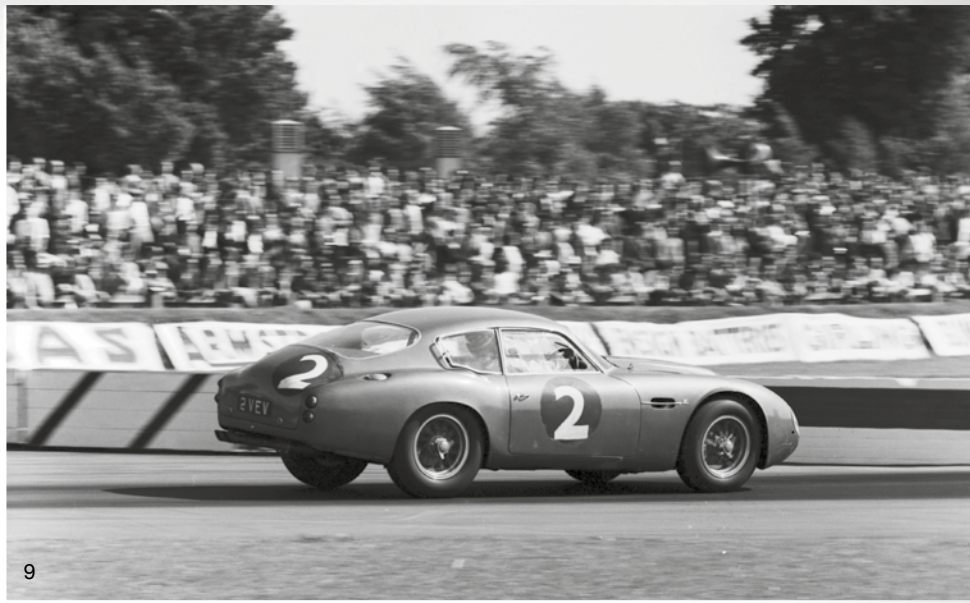

9

8 (Main)
And they're off.... Jim Clark, with an armful of opposite-lock and a cloud of tyre smoke, gets the jump on the Italian exotica and points 2 VEV in the general direction of Madgwick corner.

9
Later year, latter-day 'MP209'-specification '2 VEV' with Jimmy Clark once more giving his all during the 1962 Goodwood TT.
© Jarrots.com

10
Immortal car, legendary driver - '2 VEV' in its 1962 form is tip-toed into Woodcote Corner en route to a meeting with a Ferrari 250GTO...
© Jarrots.com

While Lucien Bianchi's Spa crash had occurred on May 20, 1962, it was as soon as July 15 that '2 VEV' in its fresh form made its racing debut driven for the Essex Racing Stable by South African works Cooper F1 star Tony Maggs in the World Championship-qualifying 300km Trophees d'Auvergne race at Clermont-Ferrand. He lost time through a cracked block causing water loss and overheating but was still able to finish seventh.

Ogier then entered both the old-style '1 VEV' and this very latest MP209 Super Lightweight '2 VEV' in the year's RAC Tourist Trophy race back at Goodwood on August 18, 1962.

Genius driver Jim Clark had just become fully established at the forefront of Grand Prix competition as Team Lotus No 1, and the year that far had seen him win both his first-ever World Championship-qualifying Grand Prix – the Belgian at Spa – and his second – the British Grand Prix, at Aintree. Now he was to handle '2 VEV' in a second consecutive RAC Tourist Trophy race back at Goodwood. To this day, his spectacular progress in this magnificent British Berlinetta remains the much-photographed stuff of motor racing legend...

After power-sliding broadside first from the startline echelon in the run-and-jump style getaway - by the 60th lap Jim Clark was running 6th overall, delayed by tyre-change stops for '2 VEV' which was eating its Dunlop rubber as its star driver drifted it spectacularly around the Sussex circuit. But, fresh from a tyre-change pit stop, Jimmy pitched the car into Madgwick Corner one more time, intent upon keep it upon the tight inside line as he had just glimpsed race leader John Surtees's plum-red Ferrari 250 GTO storming up behind.



8



10





11

However, even Jimmy's great skills could not then prevent '2 VEV' flicking broadside over the pronounced tight-line ridge at Madgwick Corner, and in an instant this Aston Martin had spun across Surtees's path, the cars colliding and both flurrying off into the left-side safety bank. Neither driver was hurt, and the Ferrari was worse damaged than '2 VEV' – but there both cars lay for fully 30 more laps until driver Robin Benson lost control of Chris Kerrison's passing Ferrari 250 GT SWB and it promptly spun off to crash into the long-abandoned cars, inflicting further damage, particularly upon the Ferrari which bore the brunt of the initial impact – while '2 VEV' escaped quite lightly.

In fact the Aston Martin was quickly repaired, and on October 21, 1962, in the Paris 1,000Kms at Montlhery, Clark ran fifth in '2 VEV' – featuring deafeningly amongst the leading group before a spin, which lost him six places. He then soared back into second position before handing over to co-driver John Whitmore only for the engine to hole a piston after two more brief laps.

Aston Martin then revived its in-house works team for 1963 with the further developed Project 214 and 215 Coupes – incorporating useful lessons learned with the rare trio of three MP209 Super Lightweight Zagatos as described here.

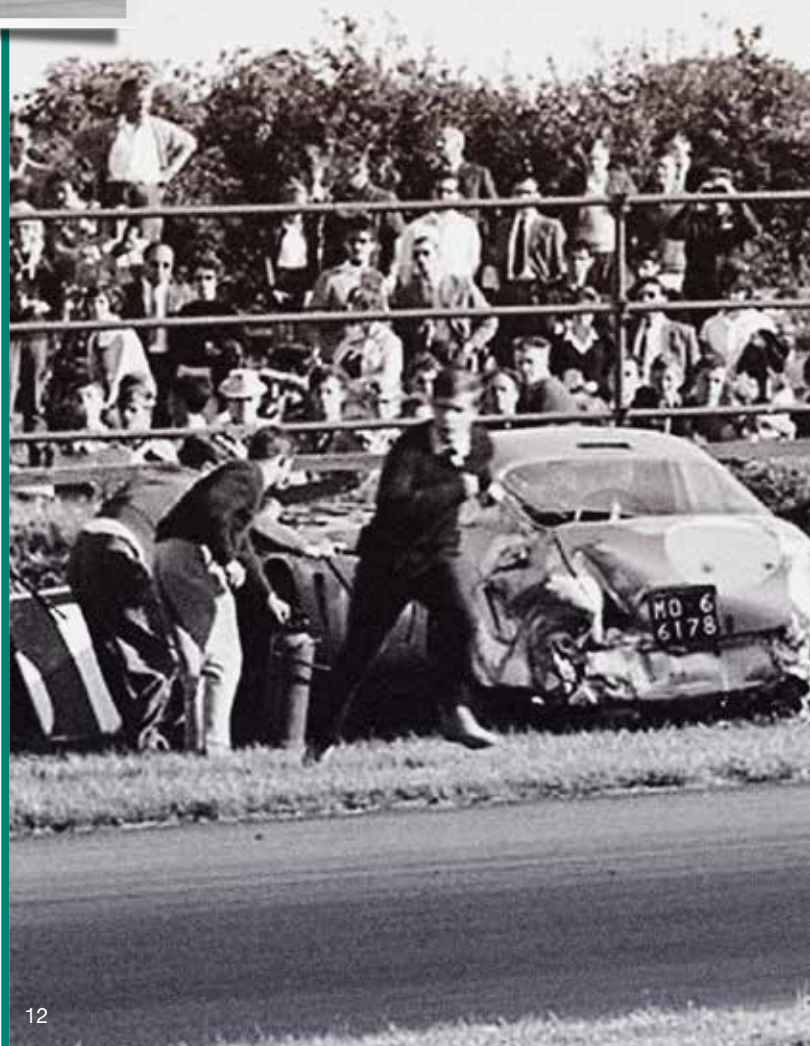

12

11

Jim Clark yet again at St Mary's - this time during the 1962 Goodwood TT in the 'MP209' specification '2 VEV'.
© GPL

12 (Main)

Best intentions: When Jim Clark tried to hold '2 VEV' in tight to allow leader John Surtees to pass unimpeded at Madgwick Corner - it all went terribly wrong. Robin Benson's Ferrari 250GT SWB crashed later at the same place, inflicting far worse damage upon the Ferrari than upon the Aston Martin.
© GPL





'2VEV' - ASTON MARTIN DB4GT ZAGATO



John Ogier eventually sold '2 VEV' in 1964 - its new owner Alexander Roch entering it for another Paris 1,000Kms race that year in which it was co-driven by Andrew Hedges/John Turner. Mr Roch recalls Andrew Hedges bringing the car into the pits at one point to complain of a smell of burning. Inspection found that the wider than normal outside rear tyre had been rubbing on the aluminium bodywork when loaded-up on Montlhéry's high banking, and extra clearance had to be "arranged" with the help of a hammer enabling him to continue. Gearbox failure finally sidelined the car.

It was subsequently sold to Hartley Whyte (of the Whyte & Mackay Whisky) family whose tenure lasted from 1965 to 1969 - when it was acquired by the enthusiastic historic racing owner/driver Nick Cussons.

He owned '2 VEV' for a little over two years, and campaigned the car regularly in UK club events. He fitted it with 15-inch diameter wheels instead of the original 16-inch in order to use wider tyres. The car proved very reliable, and Cussons achieved a number of wins at Silverstone, Oulton Park, in the AMOC's Wiscombe hill climb and at the 1970 750 MC's Six-Hour Relay Race. In June 1971 he returned '0183/R' to Aston Martin where much work was undertaken, including an engine rebuild before selling the car to prominent Club racer Roger St John Hart.

He was also another Aston Martin enthusiast and keen competitor and '2 VEV' was again extensively raced. In 1973 St John Hart also purchased another Zagato '0200/R' with engine serial '370/1288/01'.

Mr St John Hart sold '0200/R' in 1978 but retained the engine in order to install it in '0183/R' - '2 VEV'. The work was undertaken by renowned Aston Martin specialist Richard Williams. It seems that at some time in the late 1970s, engine '370/1288/01' suffered a major failure. He subsequently acquired the block from DB4GT '0122' from fellow Aston Martin racer John Goate in circa 1978 and that engine remains in the car to this day.

Roger St John Hart continued to use the car in club events until 1985, when he retired it from the racetrack, perhaps mindful of the car's now rising value. St John Hart passed away in 1989 and his widow Toni allowed '2 VEV' to return to the track in 1991, driven by its old keeper, Nick Cussons. In 1992, '2 VEV' actively competed in the FIA Historic Championship and - having contested all but one round - actually won the Championship title. The car was then kept in the Isle of Man and in 1993, whilst being driven by Cussons, was involved in a road accident.



The damage was focused upon the left-front corner and left-side bodywork but the opportunity was taken to have the Aston Martin factory specialists at Newport Pagnell not just repair '2 VEV' but actually to restore it with painstaking care and accuracy to its present – now long-maintained - concours condition.

Since the rebuild the car has not returned in anger to the track but has become a concours regular, including winning the Volz Trophy at the AMOC's summer concours in 1996 and being invited to the Pebble Beach concours in 1997, where it won the most significant British car of the show award.

The car is accompanied by four massive – and beautifully bound – documentation folders, including specific contemporary coverage of '2 VEV's first 30 years, lavishly illustrated by original photographic prints, full details – with invoices and receipts for service work carried out – including the mid-1990s post-accident restoration process – and myriad copies of magazine and specialist publication feature stories and articles published over the years featuring this ex-Jim Clark Aston Martin's intriguing story. Indeed, we have very seldom been able to offer such an important competition car with anything like as much documentary support being provided by the owner.







WALKER RACING TEAM 7

7

SHIPP ENDEAVOUR 8

8

BRUCE & BROTHERS LTD 9

9

10

11

EVEV



The car's original old-style buff UK road registration logbook chronicling the continuous history.



Perhaps most significantly, one folder includes a copy of the Aston Martin Owners' Club membership renewal by John Ogier, for 1964-65. Covering ownership of car 'DB4GT Zagato' – year '1962' – registration number '2 VEV' – and chassis number '0183/R' – he has written "Check for record. This replaced (underlined) the car written off by Bianchi at Spa in 1962 and is similar specification to the 2 'works prototypes'..." – absolutely confirming his knowledge of its very special 'MP 209' specification.

It is – in effect – the third of the three 1962 Aston Martin 'Project car prototypes' which preceded the works team's definitive Project cars of 1963. Add the Jim Clark history – plus Aston Martin's marque prestige, and '2 VEV' is plainly a massively charismatic competition Coupe indeed.

So here we offer an incredibly rare and important motor car that would provide any great collection with a truly enviable figurehead. This is one of only three very special MP209 'Super Lightweight' examples manufactured during this golden era by Britain's most significant GT car manufacturer – and the only quasi-works MP209. We rarely use the investment word, but '2 VEV' has not only been an integral and much loved family member for the past 47 years, but a fine investment too.

We commend this magnificent 'British Berlinetta' to the market.

Estimate upon request

Please note: Special bidder registration procedures apply to this Lot. If you intend to bid on this Lot you need to register your interest with Bonhams no less than 48 hours in advance of the Sale. Please also refer to the Guide for Buyers Page at the front of the catalogue.



For details of the charges payable in addition to the final Hammer Price of each Lot please refer to paragraphs 7 & 8 of the Notice to Bidders at the back of the catalogue.



© Photos Brian Joscelyne

JOHN OGIER - PRIVATEER, PATRIOT

John Lionel Eardley Ogier was Aston Martin's original customer for the 'VEV' brace of DB4GT Zagato cars. He was a pioneering businessman who was one of the immediate-postwar poultry farmers who saw the commercial potential of American-style broiler-chicken production, contributing to what became famous as the Buxted Chicken brand. With modern sensibilities that perhaps does not sit well with many people today, but in the 1950s providing affordable food to the nation was a primary concern.

John Ogier was an ex-military man, a tank section commander who had won the Military Cross for gallantry during the hotly-resisted Allied advance up the Adriatic coast of Italy. He rescued his own commander under fire and persisted in action despite being wounded. Upon recovery he was appointed Aide de Camp to Winston Churchill, no less, and upon his return to civilian life he became a captain of commerce.

His contemporary friends recall him as having been a fascinating man, fiercely intelligent, energetic, loyal, and generous. He was fiercely patriotic in a period when British industry was suffering a real crisis of confidence and one spin-off from his natural patriotism and support for British industry was his enthusiastic backing for Aston Martin.

He had been born in India, but was educated at St Edward's School, Oxford before becoming apprenticed to the Austin Motor Company, where he worked exclusively in the competitions department. He joined the Army when it became obvious war was imminent and he became a Dunkirk evacuee in 1940. He was then posted to The Queen's Own Hussars, of which Winston Churchill was Honorary Colonel, and he served with great distinction in North Africa, fighting at El Alamein, before the Italian campaign. In addition to his MC he would be further mentioned in despatches.

There were evident compensations. During leave at the Cairo Sailing Club he met his future wife, a South African M16 recruit named Wymond Paull. He was later so successful as Churchill's AdC that the Old Man wanted him to manage his Chartwell Estate - for £250 per annum. John Ogier, however, had higher ambitions...

In early 1946 borrowed £15,000 from his father and a friend to start his Essex-based chicken farming venture. It proved so successful the loans were paid off within two years.

He began club racing with a Jaguar XK120 bought in 1952. Snetterton in Norfolk became his home circuit. He met and admired John Tojeiro and became both a customer and a marque sponsor in the mid-to-late 1950s.

As a driver he was perhaps more bold than truly talented. In October 1957 he lost control of his Tojeiro-Jaguar at the Stapleford hill-climb in Essex, trackside straw bales becoming a launching ramp from which the 'Toj' somersaulted, high in the air, throwing out Ogier and inflicting serious injuries, including a badly broken leg.

He would not compete again as a driver, but his expanding business activities enabled him to acquire a pair of Formula 2 Coopers for 1958, when he entered them under the Essex Racing Stable team title for the young Sir John Whitmore and South African newcomer Tony Maggs. The cars were prepared in the stables of the family home at East Hanningfield, Essex, John and Wymond Ogier raising their four children there.

But in late 1959 David Brown announced he was withdrawing Aston Martin from full-time works racing activity, having just secured the FIA Sports Car World Championship title. John Ogier was dismayed, believing it was essential for Great Britain to have top team involvement in world-class endurance racing. He approached David Brown and John Wyer at Aston Martin, and for 1960-61 his Essex Racing Stable bought two DB4GTs '17 TVX' and '18 TVX') and subsequently Zagatos '1 VEV' and '2 VEV'.

When David Brown decided to revive his Aston Martin works team for 1963, the need for John Ogier's quasi-works operation evaporated. By that time he was living in Kent, and his other interests extended to car styling, backing British designer David Ogle and becoming Chairman of Ogle Design Ltd. The company produced the Ogle 1000 de luxe Mini, followed by the Reliant Scimitar GTE, both being very well received.

During this time, Ogier also headed the 'Movement for True Industrial Democracy', fostering worker participation and profit-sharing in industry while encouraging trades unions to commit to moderation in return.

But tragically, on 15 August 1977, John Ogier - aged 57 - lost his life whilst driving home in his Reliant Scimitar from the Hickstead Equestrian Three-Day Event. His 'Daily Telegraph' obituary reported "...he is mourned not only by his large and devoted family but by his many friends and admirers drawn from a lifetime of varied interests and enthusiasms... John Ogier was not only unfailingly generous with the gift of his own friendship but was uniquely able to use his personality to forge friendship amongst others". Here was a popular perfectionist, with a brimful life forever associated with the great Aston Martin marque.



2



3

1 Belgian Aston Martin driver Luicen Bianchi with John Ogier, MC, Aston Martin enthusiast and wealthy patron of the Essex Racing Stable.

2 '2 VEV' incognito at Montlhéry during the 1962 Paris 1,000Kms - drivers Jim Clark (dark sweater) and Sir John Whitmore to the right, British racing entrepreneur John Webb in BRDC blazer further right...

3 Paris 1,000Kms, 1962 - Montlhéry - Sir John Whitmore strolls round the nose of '2 VEV' - co-driver Jim Clark at rear of car with burly, bespectacled John Ogier...



'2 VEV' - ASTON MARTIN DB4GT ZAGATO



1984 MARCH 84G-CHEVROLET GROUP C/GTP SPORTS PROTOTYPE

Chassis no. 84G-05

- Delivered new to the USA
- In-period race history
- Full professional restoration in 2017
- Comprehensive spares package
- New FIA HTP just issued



Daytona 24-hours, 1985



In the pits, Watkins Glen, 1984

Although March's sports prototypes were overwhelmed by Porsche 962s in Group C racing in Europe, in Chevrolet V8-engined form they were popular choices for the IMSA GTP series in the USA, winning the IMSA titles in 1983 and 1984. The March 84G Chevrolet is, arguably, the best of the Adrian Newey-designed March GTP Sports Prototypes of its era. Only seven 84G models were built.

Chassis number '84G-05', fitted with a Chevrolet engine, was delivered new at the beginning of the 1984 season to John Kalagian in the USA. A well-known privateer, Kalagian raced the March in many events, including the Daytona 24 Hours and Sebring 12 Hours, until mid-1985 when he sold it back to the March factory having bought a new 85G model. During this period, Kalagian scored some excellent results with '84G-05' including a 2nd overall at the Watkins Glen 500 Kilometres (see table right).

1984

- 08/7: Watkins Glen 6 Hours: Kalagian/Lloyd, #15; 39th NR
- 29/7: Portland 3 Hours: Kalagian/Lloyd, #15; 7th
- 05/8: Sears Point 100 Miles: Kalagian, #15; 15th NR
- 26/8: Road America 500 Miles: Kalagian/Lloyd, #15; 21st NR
- 09/9: Pocono 500 Kilometres: Kalagian/Lloyd, #15; 23rd NR
- 16/9: Michigan 500 Kilometres: Kalagian/Lloyd, #15; 4th
- 30/9: Watkins Glen 500 Kilometres 2: Kalagian/Lloyd, #15; 2nd
- 26/9: Daytona Finale: Kalagian/Lloyd, #15; 26th NR

1985

- 02-03/2: Daytona 24 Hours: Kalagian/Lloyd/Grunnah, #15; 32nd NR
- 24/02: Miami GP 3 Hours: Kalagian/Lloyd, #15; 5th
- 23/03: Sebring 12 Hours: Kalagian/Lloyd/Grunnah, #15; 27th NR



'84G-05' was then acquired by another privateer, Bill McDill, and fitted with a Buick engine. McDill and Juckette competed in the Daytona 24 Hours and Sebring 12 Hours in 1988 before putting the car in storage. Still painted in its last-race-of-1988 livery, the March was offered for sale by Jim Torres in the early 2000s and was bought by a British enthusiast. The latter brought the car to the UK where a full restoration was carried out, including the fitting of an original-type Chevrolet engine. However, it was painted in the wrong livery (like the March that was raced by Emerson Fittipaldi at the Miami GP in 1985, a different chassis). '84G-05' ran in this form at the Le Mans Classic support race in 2008.

Subsequently, the March was acquired by a noted collector, who had it fully restored again in 2017 at Phil Stott Motorsport, the famous UK-based Group C specialists. The rebuild included fitting a brand new fuel injection system; a complete crack test; and installing a brand new custom-made fuel cell. Lastly, the car was repainted in its correct livery as used at the 1985 Daytona 24 Hours, when it carried competitor number '15'.

'84G-05' is now ready to race again. It comes with a comprehensive spares package that includes eight spare wheels, a refuelling rig, a set of body moulds, a spare set of bodywork, and various boxes of assorted engine, suspension, and exhaust parts. Another important factor for the future owner is that '84G-05' also comes with two large folders containing numerous period documents such as letters, race programmes, photographs, etc. New FIA HTP papers have just been issued.

This is a unique opportunity to acquire an affordable GTP Sports Prototype ready to be enjoyed at a variety of the most prestigious events; indeed, last year this March was invited to attend the exhibition of Adrian Newey cars at the Goodwood Festival of Speed. Possessing documented in-period race history, this fully restored March 84G is an opportunity not to be missed.

£180,000 - 230,000
€210,000 - 260,000

337

1967 ASTON MARTIN DB6 VANTAGE VOLANTE

Registration no. KDD 950E

Chassis no. DBVC/3618/R

- One of 29 DB6 Mkl Vantage Volantes
- Manual transmission
- Present ownership since 1989
- Un-restored and highly original
- 55,972 miles recorded





'On taking over the DB6 one is immediately astonished by its flexibility. In spite of multiple carburettor chokes, it will idle through traffic like a dowager's limousine and will accelerate on a high gear in a manner which is rare even among the biggest V8 power units.' - John Bolster on the DB6 Vantage, *Autosport*, 21st October 1966.

The culmination of Aston-Martin's long-running six-cylinder 'DB' line, the DB6 was launched at the Paris and London Motor Shows in 1965 and was recognisably related to the Touring-styled DB4 of 1958. The wheelbase was now 4" longer than before, resulting in an extensive restyle with more-raked windscreen, raised roofline and reshaped rear quarter windows. Although apparently a bigger car than its predecessors, the weight of the new model was in fact only fractionally increased. Opening front quarter lights made a reappearance but the major change was at the rear where a Kamm-style tail with spoiler marginally reduced aerodynamic drag.

The Tadek Marek-designed double-overhead-camshaft six-cylinder engine had been enlarged to 3,995cc for the preceding DB5 and remained unchanged. Power output on triple SU carburettors was 282bhp, rising to 325bhp in Vantage specification. Borg-Warner automatic transmission was offered alongside the standard ZF five-speed gearbox, and for the first time power-assisted steering was available.

After 37 Volante convertibles had been completed on the DB5 short-wheelbase chassis, the model adopted the longer DB6 chassis in October 1966. Distinguishable by its flared wheelarches and DBS wheels, the DB6 Mark 2 introduced in 1969 could be had with AE Brico electronic fuel injection. In total, 1,575 DB6 saloons were made between 1965 and 1970, plus 178 of the long-wheelbase Volante.



One of 140 DB6 Volantes Mark 1s made, and one of only 29 with the Vantage engine, '3618/R' was sold new via Plough Motors to Marwin (Anstey) Ltd of Anstey, Leicestershire and first registered as 'KDD 950E'. The accompanying copy guarantee form reveals that the DB6 was delivered finished in Olive with black trim, and that it left the factory equipped with the Vantage engine, ZF five-speed manual gearbox, chrome road wheels, 3-ear hubcaps, power operated aerial, detachable headrest in black, and a limited-slip differential with 3.73:1 final drive ratio.

Servicing is recorded up to early 1970 and there are two further owners listed: a Mr Dynes of Leicester Tyre & Battery Sales and Mr R H Williams of Caernarvonshire, North Wales. The car appears to have been in North Wales by April 1970. Three further owners are known to the AMOC: A R Pilkington of Kingsley, Cheshire (1977-1979); B R Gell (1980); and M M Wells, London (1981-1982).

The current vendor purchased 'KDD 950E' at a London auction in December 1989 (at 53,000 miles). The Aston remained in London with the owner and was regularly serviced by Ian Mason (in 1990, 1991, 1995, and 1998). The vendor then moved the car to his country house, and subsequently it was looked after by Portfield Sports Cars (2001) and then Harwoods (2003, 2004, 2007, 2008, 2010, and 2012). The owner then moved overseas and the Aston was sent to Classic Car Storage where it has been for the last four years. Maintenance during this period was entrusted to a general mechanic, as evidenced by numerous bills on file. The latter also contains numerous MoT certificates, the most recent of which was issued in April 2018.

'KDD 950E' is unusual in so far as it has never been restored (albeit a colour change) and retains its original interior trim, the latter nicely patinated. Now over 50 years old, this beautiful and rare Aston Martin convertible would benefit from cosmetic refurbishment to return to former glory and delight its fortunate next owner.

£450,000 - 550,000
€510,000 - 620,000



338

1970 FERRARI 365 GTB/4 'DAYTONA' BERLINETTA

Coachwork by Pininfarina

Registration no. EHN 326H

Chassis no. 13333

- *Delivered new to the UK*
- *Right-hand drive*
- *Matching numbers*
- *45,380 miles from new*
- *Known history from new*
- *Restored condition*
- *Ferrari Classiche certified*





'It's a hard muscled thoroughbred, the Daytona - easily the most awesome and yet disciplined road-going Ferrari in that firm's brilliant quarter century of existence. The Daytona isn't fast - it's blinding. It will eat up a quarter-mile of asphalt in 13.2 seconds at 110mph and scream out to 175mph - or it will slug through traffic at 1,500rpm with the Sunday manners of a FIAT. It is the perfect extension of its driver. You can cut and weave through shuffling traffic with the agility of a halfback, or lope down the freeway with the piece of mind that comes from knowing you can contend with anyone's incompetence. To say, after you've driven it, that the Daytona is desirable doesn't begin to sum up your feelings - you would sell your soul for it.' - *Car & Driver*, January 1970.

Every Ferrari is, to a greater or lesser extent, a 'landmark' car, but few of Maranello's road models have captured the imagination of Ferrari's like the 365 GTB/4. The ultimate expression of Ferrari's fabulous line of V12 front-engined sports cars, the 365 GTB/4 debuted at the Paris Salon in 1968, soon gaining the unofficial name 'Daytona' in honour of the sweeping 1, 2, 3 finish by the Ferrari 330P4 at that circuit in 1967. Pininfarina's Leonardo Fioravanti, later the famed Carrozzeria's director of research and development, was responsible for the influential shark-nosed styling, creating a package that restated the traditional 'long bonnet, small cabin, short tail' look in a manner suggesting muscular horsepower while retaining all the elegance associated with the Italian coachbuilder's work for Maranello.

One of Pininfarina's countless masterpieces, the influential shark-nosed body style featured an unusual full-width transparent Plexiglas panel covering the headlamps, though this was replaced by electrically-operated pop-up lights to meet US requirements soon after the start of production in the second half of 1969. Fioravanti later revealed that the Daytona was his favourite among the many Ferraris he designed.

Although the prototype had been styled and built by Pininfarina in Turin, manufacture of the production version was entrusted to Ferrari's subsidiary Scaglietti in Modena. The Daytona's all-alloy, four-cam, V12 engine displaced 4,390cc and produced its maximum output of 352bhp at 7,500rpm, with 318lb/ft of torque available at 5,500 revs. Dry-sump lubrication enabled it to be installed low in the oval-tube chassis, while shifting the gearbox to the rear in the form of a five-speed transaxle meant 50/50 weight distribution could be achieved. The all-independent wishbone and coil-spring suspension was a recent development, having originated in the preceding 275GTB. Unlike the contemporary 365GTC/4, the Daytona was not available with power steering, a feature then deemed inappropriate for a 'real' sports car. There was, however, servo assistance for the four-wheel ventilated disc brakes. Air conditioning was optional, but elsewhere the Daytona remained uncompromisingly focussed on delivering nothing less than superlative high performance.



At the time of its introduction in 1968 the Daytona was the most expensive production Ferrari ever and, with a top speed in excess of 170mph, was also the world's fastest production car. Deliveries commenced in the second half of 1969 and the Daytona would be manufactured for just four years; not until the arrival of the 456 GT in 1992 would Ferrari build anything like it again. Only 1,300 Berlinetta models and 121 Spyder convertibles had been made when production ceased in 1973. Of these, only some 400 were of the original Plexiglas type, and these early examples have become the most sought after.

One of only 149 Daytonas manufactured in right-hand drive configuration, this is a wonderful example of the most sought after 'Plexiglas' variant of the 365 GTB/4. Chassis number '13333' is a well-known car, being one of only 42 right-hand Plexiglas models made, and the only one of that type finished in the most attractive colour combination of Argento Auteil Metallizzato (silver) with Rosso (red) leather interior from new. It was built in April 1970 and supplied new by Maranello Concessionaires to the famous Ferrari collector, Sir Eric Miller, in May of that year.

The Daytona was kept by Sir Eric Miller for a few years before being offered for sale by David Clark Cars in Finchley with 24,000 miles recorded. It enjoyed two further owners in the early 1980s - a Mr R Penfold and a Mr C Emson - and was offered for sale in 1984 by Michael Fisher with 29,000 miles on the odometer.

The Ferrari then remained in long-term ownership in the UK before being bought by Hexagon Classics in mid-2007. It then spent a few years in Australia before returning to the UK in 2015.

An older restoration, still in superb condition, the Daytona displays a believed genuine 45,380 miles on the odometer; it features fully restored and correct Cromodora alloy wheels, has the correct wood-rim steering wheel, and no headrests. The car retains matching numbers and correct factory colours, and has been assessed and Classiche certified by the Ferrari factory. It also comes with history reports from Marcel Massini and Ed Callow.

There are never that many Plexiglas Daytonas for sale, and few of those will be UK right-drive examples like this car, as only 42 were made. Representing the iconic Daytona in its earliest and purest Plexiglas form, '13333' comes complete with tool kit, owner's book pack, current MoT, V5C document, and the all important Ferrari Classiche certification. The vendor has a set of Borrani wire wheels available via separate negotiation should the successful bidder require.

£580,000 - 640,000
€660,000 - 730,000



339

1936 AC 16/70HP MARCH SPECIAL SPORTS TOURER

Registration no. CLY 126

Chassis no. L370

- One of only 23 with 'Earl of March' coachwork
- Present ownership since 1995
- Totally restored in the late 1990s
- Maintained with no expense spared
- Extensively rallied



Financial difficulties saw AC taken over by the Hurlock brothers in 1930, and from then on the firm concentrated on sporting cars aimed at the discerning enthusiast. Existing stocks of spares were used at first but when these began to run out the brothers had no option but to make a fresh start. This they did using a bought-in chassis from Standard, into which went the Weller designed six and a conventional ENV gearbox. The marque's reputation for producing well engineered and equally well finished cars continued under the Hurlocks' ownership, enabling AC to prosper despite the higher asking prices that these exemplary standards necessitated.

An improved, under-slung chassis of 9' 7" wheelbase was adopted for AC's 1934 range, which was first displayed at the London Motor Show in October 1933. By 1935 a flat radiator with mesh grille had replaced the previous rounded type, only to be superseded for the following season by the classic slatted version. A synchromesh gearbox was standard by this time, while other noteworthy features included automatic chassis lubrication, built-in jacks, and Telecontrol shock absorbers, all of which were incorporated in the 16/60hp and 16/70hp models launched in 1936.

The combination of a generous wheelbase and low-slung chassis made it possible for the six-cylinder AC to accommodate sports-touring coachwork that was both stylish and comfortable.



Among the most elegant was the four-seater sports tourer designed by Freddy March, heir to the Duke of Richmond and Gordon, whose design team was responsible for some of the finest sporting coachwork of the period. It is believed that fewer than 600 of these standard 16hp cars were built before production ended in 1939, of which only 23 featured 'Earl of March' coachwork.

This rare sporting AC was first owned by one V H Holloway in 1936, and by the 1950s had passed into the ownership of Leslie Inwood, the AC Car Club's race secretary. In 1963/1964, the car was owned by Ian McKinnon who sold the car through Branscombe Garage, and subsequently by Tom Burnside, a motoring photographer from New York, USA. Sold at auction to a lady from Boston, USA, the AC was owned subsequently by Mark Gibbons, a resident of Boston, USA and Portugal. In 1995, the current vendor purchased the car, which he had shipped home to the UK from Portimao, Portugal.

The AC's restoration commenced the following year when the engine was rebuilt by Colin Dunn of Solent Vintage Engineering. Phil Whitaker then totally rebuilt the chassis and body over the course of 1998/1999, the interior being re-trimmed by specialist upholsterers J G Luck of Poole. By this time, in excess of £75,000 had been spent on the AC's restoration.

Jim Stokes Workshop looked after the AC's maintenance over the course of the next decade, carrying out various tasks including re-coring the radiator; fitting new splined hubs; overhauling the suspension, brakes, steering, etc, a further £15,000-or-so being spent. In 2008, Rod Briggs rebuilt the engine again around the original cylinder block (stitched by Surelock) at a cost of £25,000, which included an upgrade that increased maximum power to 89bhp, while the wheels were rebuilt in 2010. The only notified deviations from factory specification are the dashboard's leather trim and enamelling to the AC bonnet badge.

Since the initial restoration's completion some 19 years ago, 'CLY 126' has been rallied extensively by the enthusiast vendor. Events entered include the 'London to Lisbon Rally' (2000), 'Angoulême Amble' (2005), 'Pyrenean Challenge' (2006), 'Wonders of Burgundy' (2007), 'Unknown Italy' (2010) 'Wolseley Car Club 1000 Miles of Ireland' and various other tours of Brittany, France, and Belgium. On several of these events 'LC370' was voted 'the car they would most like to take home' by its fellow competitors. Described by the private vendor as in generally very good condition, this handsome AC represents a wonderful opportunity to acquire one of the most exclusive and sought after British sports cars of its era.

£90,000 - 120,000
€100,000 - 140,000

340

1929 BENTLEY SPEED SIX 'LE MANS REPLICA' TOURER

Registration no. GK 2472

Chassis no. SB2751

- *One of only 121 Speed Sixes on the SP2 short chassis*
- *Originally an H J Mulliner-bodied saloon*
- *Vanden Plas-style 'Le Mans Team Car' body*
- *Used sparingly in recent years*
- *Eligible for a wide variety of the most prestigious historic motoring events*





'It is extraordinarily difficult to explain in words or writing the exact fascination of a big, fast car of the type so ably represented by the big Bentley speed model.' *The Autocar* on the Bentley Speed Six, September 5th, 1930.

Although the 6½-Litre had been conceived as a touring car to compete with Rolls-Royce's New Phantom, in Speed Six form it proved admirably suited to competition. In 1929 Barnato/Birkin's Speed Six won the Le Mans 24 Hour Race ahead of a trio of 4½-Litre Bentleys, and Barnato/Kidston repeated the feat in the following year's Grand Prix d'Endurance at the Sarthe circuit ahead of similarly-mounted Clement/Watney. Small wonder then, that the fast yet refined 6½-Litre Speed Six was W O Bentley's favourite car.

Walter Owen Bentley had established Bentley Motors in 1919 in the North London suburb of Cricklewood, though deliveries did not begin until 1921. The first model, a 3-litre car, was powered by a four-cylinder, single overhead camshaft engine with four valves per cylinder.



'SB2751' on the Bentley stand at the 1929 Motor Show, with original H.J. Mulliner Sports Saloon coachwork fitted © Clare Hay

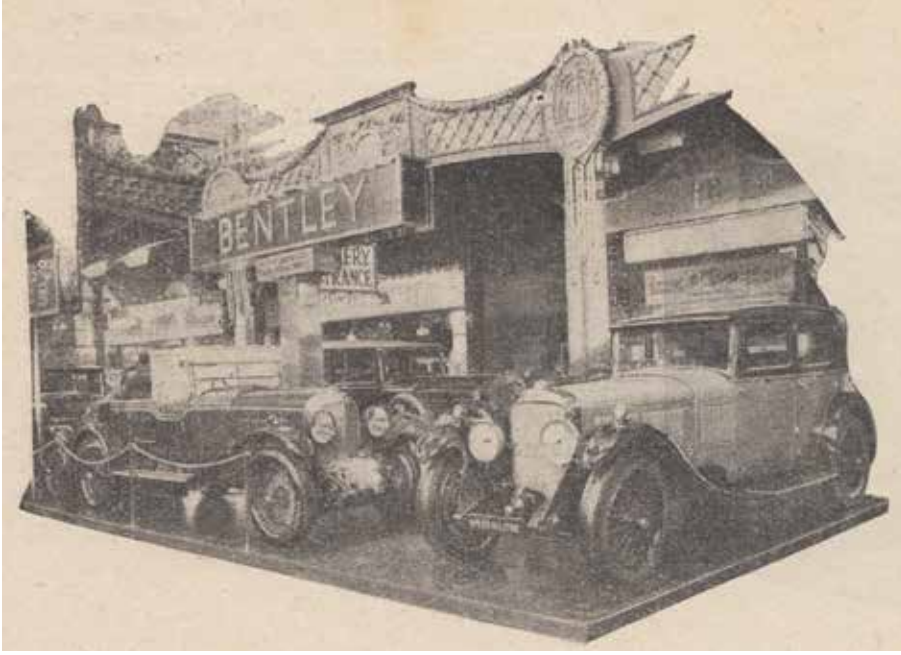

'SB2751' as originally bodied as a Sports Saloon by H.J. Mulliner, 1929 © LAT



It was a mechanical theme perpetuated in the greatly refined six-cylinder 6½-Litre model of 1926. The need for a larger car had resulted from Bentley's customers specifying bodies of a size not envisaged when the 3-Litre was conceived, a factor only partially addressed by the introduction of the Long Standard chassis in 1923. The 6½-Litre was produced for four years, during which time 544 chassis were completed, 182 of them to Speed Six specification.

According to Clare Hay's authoritative work, *Bentley: The Vintage Years*, this particular Speed Six, registration number 'GK 2472', is one of only 121 6½-Litre models erected on the short 'SP2' (11' 6") chassis. The car was originally bodied by H J Mulliner as a Weymann-type saloon and displayed on Bentley Motors' stand at the Olympia Motor Show in 1929. It was retailed via Jack Barclay and first owned by one W G Sykes of Edgerton, Huddersfield. Hay lists four further owners: G A Gibb (1935), H S Scott (1939), Ronald Loader (1948) and W Nicholson (1954) noting 'sold as chassis by Nicholson'.





By 1995, one M Woodcock owned the Bentley, which later that same year was acquired by renowned marque specialist, the late Stanley Mann. The Vanden Plas Team Car replica body was fitted by Mann circa 1996, while the engine, 'FW2603' is from 6½-Litre chassis number 'FW2619'. Manfred Oprée purchased 'GK 2472' in 1996, his 4½-Litre Bentley being taken in part exchange, while the rear spring height was corrected and a new camshaft fitted at time of delivery. In 1998, the current vendor acquired a half share in the Bentley, becoming its outright owner in 2011.

This Speed Six has been sparingly used over the last few years but is expected to be freshly serviced by the time of sale. Accompanying documentation consists of old-style FIA papers (dated 1996), a copy of the Bentley service record, a UK V5 registration document, and sundry invoices for minor works carried out over the years. A wonderful opportunity to own one of the most desirable of all 'W O' Bentleys, eligible and supremely suitable for a wide variety of the most prestigious historic motoring events.

£800,000 - 1,000,000
€910,000 - 1,100,000



341

1968 JENSEN FF MKI COUPÉ

Registration no. BTU 16F

Chassis no. 119/022

- One of only 193 Mk1 FFs made
- First owned by Sir Richard Seifert
- Automatic transmission
- Present ownership since March 2015
- Recent full overhaul by marque specialists Cropredy Bridge
- Substantial history file





Star of the 1966 London Motor Show, the Interceptor-based Jensen FF represented one of the first successful attempts to produce a four-wheel-drive passenger car. 'FF' stood for 'Ferguson Formula', a four-wheel drive system developed by the Harry Ferguson Research Company, which was also responsible for adapting the FF's Dunlop Maxaret anti-lock braking system for automotive use.

The FF debuted alongside the new Interceptor and both models used the same basic chassis, running gear, and 6,276cc Chrysler V8 engine inherited from the preceding C-V8. With 325bhp (SAE) and 425lb/ft of torque on tap, performance was more than adequate, The Motor recording a top speed of 140mph with 100mph arriving in 19 seconds. Leather upholstery, reclining front seats and walnut veneer were all standard features, while automatic transmission was the choice of almost all buyers (it was the only option for the FF). In October 1969 a significant number of improvements heralded the arrival of the 'MkII'.

The newcomer incorporated revised front suspension and Girling brakes (introduced on late MkIs) as well as a new front bumper and countless minor alterations. The main improvement though, was a completely redesigned interior featuring a new dashboard and seats. Mechanical changes to the FF kept abreast of those made to the Interceptor, but although the two models looked indistinguishable from a distance there were numerous subtle differences, the most obvious being the FF's twin side vents.

Priced at 30% above the Interceptor, itself not a cheap car, the FF was the privilege of a wealthy few, and when production ceased in 1972 only 302 had been made, 193 of which were to MkI specification like that offered here.

First registered on 5th February 1968, this Jensen FF had been ordered by Lieutenant Colonel Richard Seifert, the famous architect responsible for designing London's Centrepoint tower block. In 1987, the car was purchased at auction by newspaper magnate, Eddie Shah, and remained in his collection until 1990. Its next owner was an Aston Martin collector, and the FF has clearly benefited from such enthusiast ownership. The current vendor purchased the Jensen at a UK auction in March 2015 and immediately despatched it to marque specialists Cropredy Bridge Motors for a full overhaul at a cost of circa £20,000 (bills on file).

Finished in Crystal Blue with dark blue leather trim, the car benefits from a full-length Webasto sunroof and is described by the private vendor as in good condition throughout. Offered with a V5C document, MoT to June 2019, and a substantial history file, this early Jensen FF is ready to be used and enjoyed.

£80,000 - 120,000
£91,000 - 140,000

For details of the charges payable in addition to the final Hammer Price of each Lot please refer to paragraphs 7 & 8 of the Notice to Bidders at the back of the catalogue.

342

Fully restored and offered with Ferrari Classiche Certification

1960 FERRARI 250 GT COUPÉ

Coachwork by Pininfarina

Registration no. 662 YUN

Chassis no. 1567GT

- Delivered new to the USA
- Left-hand drive
- Landmark Ferrari model
- Repainted by Carrosserie Lecoq in 2013
- Engine fully rebuilt in 2014
- Ferrari Classiche certified



By the early 1960s, road car production had ceased to be a sideline for Ferrari and was seen as vitally important to the company's future stability. Thus the 250, Ferrari's first volume-produced model, can be seen as critically important, though production of the first of the line - the 250 Europa, built from 1953 to '54 - amounted to fewer than 20. Before the advent of the Europa, Ferrari had built road-going coupés and convertibles in small numbers, usually to special customer order using a sports-racing chassis as the basis. Ghia and Vignale of Turin, and Touring of Milan were responsible for bodying many of these but there was no attempt at standardisation for series production and no two cars were alike.

The introduction of the 250 Europa heralded a significant change in Ferrari's preferred coachbuilder; whereas previously Vignale had been the most popular carrozzeria among Maranello's customers, from now on Pinin Farina (later 'Pininfarina') would be Ferrari's number one choice, bodying no fewer than 48 out of the 53 Europa/Europa GTs built. Pinin Farina's experiments eventually crystallised in a new Ferrari 250 GT road car that was first displayed publicly at the Geneva Salon in March 1956. However, the Torinese carrozzeria was not yet in a position to cope with the increased workload, resulting in production being entrusted to Carrozzeria Boano after Pinin Farina had completed a handful of prototypes.



True series production began with the arrival of Pininfarina's 'notchback' Coupé on the 250 GT chassis, some 353 of which were built between 1958 and 1960 within the sequence '0841' to '2081'. However, the relatively small scale of production meant that cars could still be ordered with subtle variations according to customer choice, as well as enabling a handful of show cars and 'specials' to be constructed on the 250 GT chassis.

A number of important developments occurred during 250 GT production: the original 128C 3.0-litre engine being superseded by the twin-distributor 128D, which in turn was supplanted in 1960 by the outside-plug 128F engine which did away with its predecessor's Siamesed inlets in favour of six separate ports. On the chassis side, four-wheel disc brakes arrived late in 1959 and a four-speeds-plus-overdrive gearbox the following year, the former at last providing the 250 GT with stopping power to match its speed. More refined and practical than any previous road-going Ferrari, yet retaining the sporting heritage of its predecessors, the 250 GT is a landmark model of immense historical significance. Despite this, original survivors are relatively few, as many have been modified and converted into replicas of more exotic Ferraris such as the 250 GTO, Testarossa, etc.

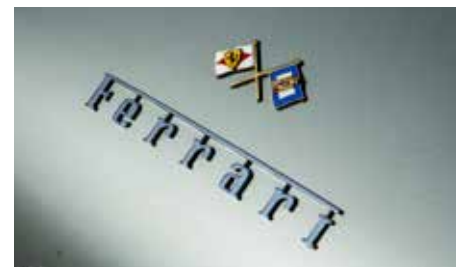



This example was despatched to the USA in November 1959. Finished in its original colour of Grigio Conchiglia, with tan leather interior, chassis number '1567' is the 19th of 147 Series IIs built. The car has benefited from considerable expenditure in recent years, with various works undertaken by Maranello Rosso of Madrid and Carrosserie Lecoq of Paris, the latter treating the Ferrari to a bare metal repaint in 2013 costing in excess of €18,000.

In 2014, the engine was completely overhauled by marque specialists Joe Macari Servicing Ltd of London. The motor was rebuilt around a new and correct replacement cylinder block, supplied by Ferrari, while the original cylinder heads, crankshaft, and connecting rods were retained. At the same time, the cylinder heads were modified to accept coil valve springs, replacing the original hairpin type, an arrangement adopted by Ferrari on the 128F version of Colombo's versatile V12. Other works carried out included sourcing a correct set of carburettors (from the USA) and fitting a correct set of Borrani wire wheels shod with new Pirelli Cinturato tyres. The all-important Ferrari Classiche certification was then obtained, the cost of all these works amounting to more than £120,000 (bills on file). A wonderful opportunity to acquire a fine example of this landmark, yet undervalued, Ferrari Gran Turismo that helped cement Maranello's fruitful relationship with Carrozzeria Pininfarina.

£550,000 - 650,000
€630,000 - 740,000



343

The ex-John Bridges/John Lepp

1968 CHEVRON B8 COUPÉ

Chassis no. DBE 52

- In-period race history
- BMW 2.0-litre engine
- Formerly part of Lord Drayson's collection
- One of the most competitive Chevron B8s
- Maintained by Blakeney Motorsport with no expense spared
- Current FIA HTP





Unlike the greater majority of Britain's racing car industry, which is located between London and the south midlands, Chevron hailed from Bolton in Lancashire. The company was founded by Manchester-born Derek Bennett, a talented engineer and successful racing driver in the Clubman's Formula category. Built for the latter, his first car was the 1,172cc Ford-powered Bennett Special, which was followed by a one-off Formula Junior, though that failed to match the success of the Clubman's car. Nevertheless, there was sufficient demand for the latter for Bennett to set up as a constructor in the mid-1960s.

Nowadays Chevron is best remembered for its highly successful small-capacity sports and GT cars and its Formula 2, Formula 3, and Formula 500 single-seaters. A Formula 1 car was on the stocks at the time of Bennett's tragic death in a hang-gliding accident in 1978, and although it was later completed, the company never progressed any further in motor racing's premier category. Following Bennett's death, the company was run by his sisters for a short while before passing into other hands.

Chevron's highly successful family of Gran Turismo cars had commenced in 1966 with the Chevron GT or B3, forerunner of the B8. Built around a multi-tubular spaceframe chassis and powered, usually, by either BMW or Ford-Cosworth four-cylinder engines, these early cars established the fledgling company as a force to be reckoned with in international sports car racing's 2-Litre class.

Bennett's cars soon gained a reputation for winning 'straight out of the box' (the first Chevron GT had done just that) and this was reflected in the immense success of the ubiquitous B8, with 44 finding customers between 1968 and 1970. Originally built for Group 4 competition, it remains a popular 'continuation' car today.



01, 02 & 03

John Bridges/John Lepp, BOAC 500, Brands Hatch, April 1968

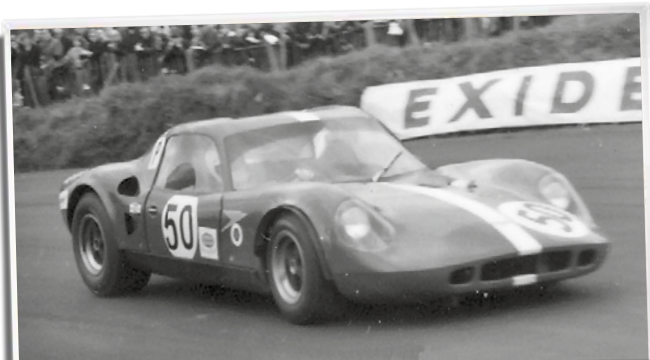

01

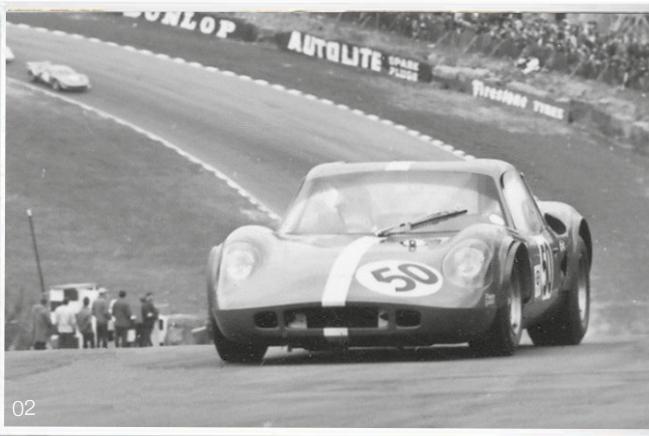

02

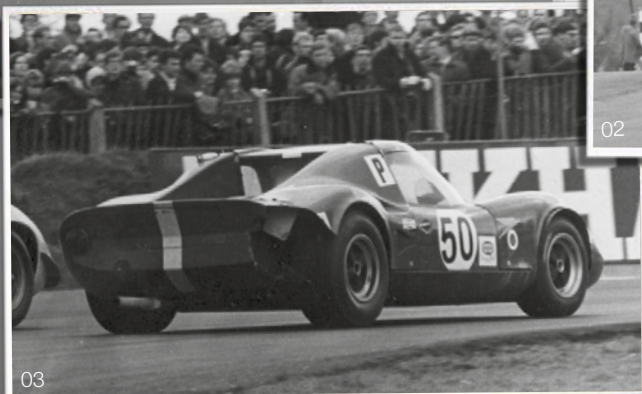

03

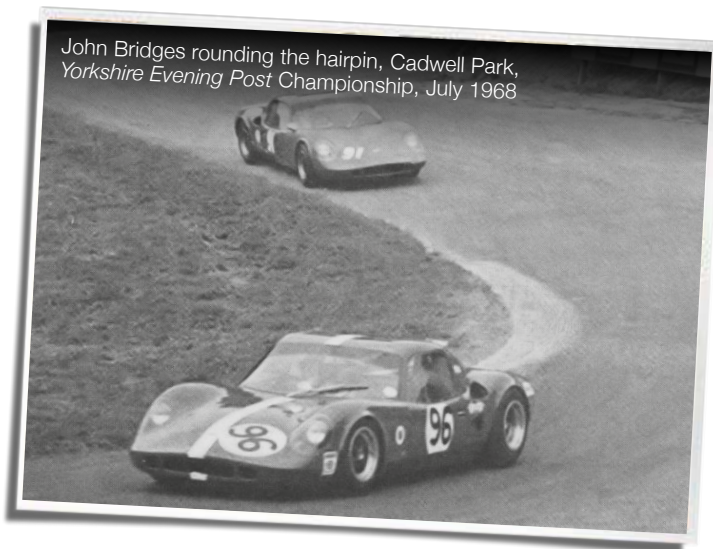

John Bridges rounding the hairpin, Cadwell Park, Yorkshire Evening Post Championship, July 1968

Pete Smith on the way to finishing 1st, Mallory Park, SKF GT Championship, May 1970

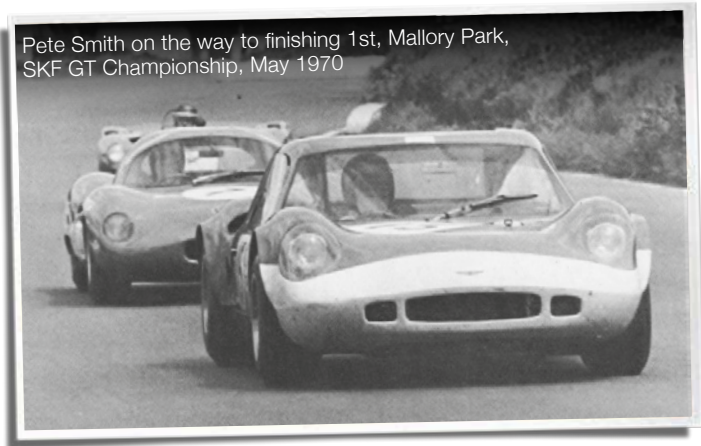

The Chevron B8 is widely regarded as not only among the most beautiful sports-racing cars ever produced, but also one of the best handling. The example offered here, chassis number 'DBE 52', was originally constructed for racing in Group 6 and fitted with a 1,600cc Ford-Cosworth FVA engine. One of the most successful in existence, it was delivered new to John Bridges and campaigned extensively throughout 1968 and 1969 by him and co-driver John Lepp, another noted Chevron exponent who had won the Motoring News GT Championship in 1967 at the wheel of a B3. They raced 'DBE 52' at numerous events and venues including the Spa 1000 Kilometres, Cadwell Park, Brands Hatch 6 Hours, and Paris 1000 Kilometres, and secured a famous overall victory at Oulton Park.

Later in 1969, the B8 was sold to Peter Smith, who continued adding to its already illustrious race history, securing a podium finish in the Martini Trophy at Silverstone in 1970. In a competition career spanning four seasons of international and British club racing, 'DBE 52' took part in 88 races, won 16 of them, and managed to finish on the podium 45 times. At some time, the Cosworth engine was removed, and for many years 'DBE 52' has had a 2.0-litre BMW engine installed.

For some nine years during the 2000s, 'DBE 52' formed part of Lord Drayson's famous collection, and while there was looked after by Martin Stretton. While in Lord Drayson's ownership, it has proved to be one of the most competitive Chevron B8s, racing successfully around the world in the hands of its owner and Stretton.

Since its acquisition by the current vendor, 'DBE 52' has competed at the Donington Festival (2015 and 2016), Silverstone Classic (2016), and VSCC Pomeroy Trophy (2017). The car has been fully race prepared by Blakeney Motorsport Ltd with no expense spared (bills on file). Recently repainted, it is fitted with a newly rebuilt Lester Owen engine (228bhp at 7,750rpm) and has a new gearbox, including internals. Other noteworthy features include a six-point roll cage; new Bilstein shock absorbers; new fire extinguishing system; rebuilt and crack tested suspension; fully silenced exhaust system (105db); and two sets of wheels. Fully race ready and a podium contender in the right hands, this historic Chevron B8 is offered with current FIA HTP papers (valid until 2026).

£250,000 - 300,000
€290,000 - 340,000

344 *

The ex-Jerry Leonard, present owner since 1995

**1955 AUSTIN-HEALEY 100S
SPORTS RACING TWO-SEATER**

Registration no. not registered in UK

Chassis no. AHS 3608

- *One of the original 50 customer competition cars*
- *Known period history*
- *Long-term current ownership*
- *Well known and respected by the Healey fraternity*
- *Mille Miglia retrospective entrant and eligible for multitude of historic events*





This handsomely presented example of the rare and highly desirable sports-racing Austin-Healey 100S is the 18th example of the total production of only fifty completed - plus an additional five works and special test cars - that were hand-made by the Donald Healey Motor Company at Warwick, England.

During the 1950s the most accessible, most appealing and in many cases the most successful club racing car available to any aspiring racing driver was the 100S. It offered more performance for the purchase price than almost any other sports car on the market, proving to be hugely successful in national and international road and track racing. That versatility is exemplified today, equally at home at events such as Le Mans Classic, Monaco Historique, Goodwood Revival, Monterey Historics, Mille Miglia Restrospective, Tour Auto and many more.

The 'S' stood for 'Sebring', in honour of the factory entered and 100-based Special Test Car's success with Lance Macklin and George Huntoon at the 1954 Sebring 12-Hours. The car astounded more thoroughbred opposition finishing 3rd overall and 1st in class, pretty much sandwiched between two sports-racing Lancia D24s. The further developed Works prepared competition model thus being called the 100S.

Chassis 'AHS 3608' was delivered new from the British factory to BMC Distribution of San Francisco, California. The American distributor initially ordered two such cars, later adding four more, and this particular example was one of those six shipped to the Bay city.

We understand this particular example was probably bought off the showroom floor for street use as one of its first owners replaced its original plexiglass windscreen with a regular folding screen from the sister 100 model. It subsequently found its way to Ohio where it found its métier, becoming an active racing machine on the circuits of the USA. After a long life as a club racing car within the USA it was eventually sold by Healey aficionado Bill Wood in 1986 to the like-minded Jerry Leonard.

This particularly active 100S was subsequently the first to be restored by Fourintune, the respected US-based marque specialist restoration company. The car was then shown at the AHCA conclave held in Oklahoma in 1988, alongside Fred Hunter's familiar red-liveried 100S. It won the Concours held there, and Carroll Shelby was the guest of honour who sat in this car while relating typical tales of derring-do about his own racing experiences with a 100S in such events as the mighty 1954 Carrera PanAmericana through Mexico.



Concours honours continued with '3608' winning the Chicago Historic Races Concours at Elkhart Lake, the Vintage Sports Car Show competition at the Brooks Stevens Museum, and also judged Best of Show at the AHCA HealeyFest IV event.

The restoration work completed upon this car was reported in detail in two publications - *'Carrozzeria 9'* and the *Pacific Centre's Austin-Healey* magazine. This car was featured on the front cover of the February, 1988, issue of the Healey magazine - while a complete account of the car's restoration by specialist Tom Kovacs of Fourintune followed in the April and May issues of that year.

The wonderfully well detailed account of the car's restoration tells how the chassis and bodies for these fine cars were produced in batches of ten by the Jensen works in West Bromwich, England, alongside all the standard Healey 100 model. Each batch was then shipped to the Healey Motor Company's Warwick works where the uprated and competition derived drive-train would be installed and final assembly completed.

Hand finishing was very much the order of the day, and each batch of 100S cars was likely to emerge with its own particular characteristics. When the restorers investigated 'AHS 3608' now offered here they found that it "...did not appear to have been taken apart..." and also that "...The gearbox, engine, chassis, trim and registration panel all matched the original records. More unusually, the engine and rear fenders had never been removed. Behind the gas tank we found an original piece of armacord and under the roll-bar flange we found a scrap of the original interior vinyl. Once again luck was with us..."

The car had sustained some front-end damage, the front surround having been replaced as had the original aluminium front fenders - in their case by steel BN2 fender panels. The description of this rare Healey's restoration goes on to explain how it was fitted from new with a plastic rimmed 'banjo' steering wheel, the chassis is to factory specification with lightweight-alloy, in places drilled, to save further weight"



The Austin-Healey 100 model itself was produced by Austin-Healey from 1953 until 1956 and was based upon Austin A90 Atlantic mechanicals, hugely enlivened by ingenious fine-tuning and adoption of the striking Healey sports car body design. A single Healey '100' had been displayed at the 1952 London Motor Show which hugely impressed Austin managing director Leonard Lord, who was seeking a replacement for the unsuccessful A90. Body styling was by Gerry Coker, chassis design by Barry Bilbie. To minimise overall vehicle height the rear axle was underslung, the chassis frame passing beneath the rear axle assembly.

The '100' was named by Healey for the car's ability to reach 100 mph (160 km/h), while the lighter competition derived aluminium-bodied '100S' model offered a very respectable 132 bhp at 4,700 rpm – over 30% more than the standard engine's output. Weight was minimised and performance enhanced by replacement of the engine's standard cast-iron cylinder head by a bespoke Weslake-designed eight-port aluminium component, further tweaks to the standard block, and larger carburettors.

Dunlop disc brakes were used all-round, the 100S becoming the world's first production car to feature them both front and rear. To further lighten the vehicle, bumpers and convertible top were eliminated, the grille reduced in size, and the standard windscreen made of plastic - overall saving some 200lbs (91 kg). The majority of 100Ss were the classic Old-English White over Lobelia Blue like 'AHS 3068' offered here.

The car is offered from the private collection of a prominent Swiss Austin-Healey enthusiast who acquired it from the widow of leading American Austin-Healey Club personality Jerry Leonard in 1995. The car's engine was completely rebuilt in 1998 by respected marque specialist Denis Welch, and it has featured in a number of historic events including the 2006 Mille Miglia Retro. The owner – a member of the Swiss-based Scuderia Cento S Club – has favoured rallies, tours and hill climbs to Historic circuit racing and we recommend the closest consideration of this lovely '100S', which is highly regarded by the immensely well-respected marque and model authority Joe Jarick...

Please note this Lot is subject to the reduced import tax of 5% should it remain in the EU.
£580,000 - 640,000
€660,000 - 730,000

345

**1961 JAGUAR E-TYPE SERIES I 'FLAT FLOOR'
3.8-LITRE ROADSTER**

Registration no. 863 FAY

Chassis no. 850227

- *One of the earliest surviving right-hand drive roadsters*
- *Delivered new in the UK*
- *Matching chassis, engine, and registration numbers*
- *An older restoration*





Its gorgeous appearance notwithstanding, taller drivers could find Jaguar E-Type's interior somewhat lacking in space, a criticism addressed by the introduction of foot wells (and other, more minor modifications) early in 1962. But of all the versions of Jaguar's long-lived and much-loved sports car, it is the very early 'flat floor' 3.8-litre cars built prior to February 1962 which, for many enthusiasts, remain the most desirable.

Dating from the first few weeks of production, this stunning example is one of the earliest surviving right-hand drive Jaguar E-Type roadsters (the chassis number sequence commenced at '850001') and was sold via Henlys Limited, London to first owner Miss E Roberts of London W2. Chassis number '850227' was despatched from the works on 14th October 1961 and was originally finished in Opalescent Dark Green with Suede Green interior trim and French Grey soft-top.

By March 2010, the E-Type was registered in Monaco in the ownership of Mr Peter J Bentley, who drove the car regularly to keep it in good running condition. Email correspondence on file confirms that '863 FAY' is the original registration number, and Mr Bentley goes on to say that the E-Type had been rebuilt to concours winning standard with several show wins in the UK, including the Midlands JDC Concours (for originality). In his estimation, the car was 'an older restoration with a great patina and a lived in feel but still in great condition'.

Further email correspondence reveals that '850227' had been purchased as a restoration project in the late 1970s and restored by Classic Cars of Coventry in 1980/1981, its colour scheme being changed to the present red/black in the process. This E-Type has also been displayed on the JDC's stand at the NEC Classic Car Show, appeared on BBC Television's *Top Gear* programme, and been featured in *Supercar Classics* magazine (Autumn 1985 edition). On *Top Gear*, the E-Type was driven at Jaguar's Brown's Lane works by the company's former Technical Director and Vice Chairman, William Heynes CBE.

Representing a wonderful opportunity to own the most desirable of all E-Type models, '863 FAY' comes with the optional works-specification hardtop, sundry restoration invoices, UK V5C registration document, and a Jaguar Daimler Heritage Trust Certificate confirming matching numbers.
£160,000 - 200,000
€180,000 - 230,000

346

One owner and 430 miles from new

2012 MCLAREN MP4-12C COUPÉ

Registration no. LA12 WAU

Chassis no. SBM11AAB6CW000830

- Left-hand drive
- 200mph-plus performance
- Full McLaren service history
- Freshly serviced by McLaren Ascot



Having astonished the world with its debut supercar of 1992 - the iconic, Le Mans-winning F1 - McLaren re-established itself at the head of the exclusive '200mph' club with the MP4-12C. Publicly unveiled in September 2009, the mid-engined MP4-12C commenced manufacture at McLaren's new state-of-the-art factory at Woking in mid-2011, just after production of the Mercedes-Benz SLR McLaren model had ceased. Its stylist was Frank Stephenson, who had been recruited from Alfa Romeo Centro Stile following spells with Ferrari and FIAT.

Like its F1 and SLR predecessors, the MP4-12C used a carbon-fibre 'MonoCell' body tub, albeit one that now took considerably less time to produce thanks to advances in composites manufacturing technology. This time the occupants' two seats were arranged conventionally side by side, unlike the F1's unusual three-abreast layout, which placed the driver in the centre, though the use of dihedral doors maintained a familial link with the F1.

BMW and Mercedes-Benz respectively had supplied engines for the F1 and SLR, but for the MP4-12C, McLaren decided to develop its own. The rights to an Indy Car V8 racing engine were acquired from Tom Walkinshaw Racing, and with assistance of Ricardo this was transformed into a 3.8-litre twin-turbocharged unit suitable for a road car. Manufactured by Ricardo at its Shoreham-by-Sea factory, the M838T engine produced 592bhp initially (more following upgrades) with 80% of its maximum torque available as low as 2,000 revs. Power was transmitted via a dual-clutch 'seamless shift' seven-speed semi-automatic gearbox - technology developed in Formula 1 - that permitted pre-selection of the next gear. Another Formula 1 spin-off was 'brake steer' technology, which applies the inside rear wheel's brake during hard cornering to counter the effects of understeer.

All modern supercars are designed with racetrack performance as a priority, but with the MP4-12C McLaren pulled off the difficult trick of endowing it with a ride quality approaching that of a luxury saloon. As Autocar observed: 'The 12C's suspension is remarkable for its ability to absorb bumps and maintain an eerie freedom from pitch and roll, regardless of whether you're on a motorway or a mountain pass.'



To reach the outer limits of the McLaren 12C's ability you'll need a circuit.' And a circuit would certainly be needed to exploit its manufacturer's claimed top speed of 207mph (333km/h), though it is worth mentioning that *Sport Auto* magazine achieved an indicated 346km/h (215mph) in 'their' car...

The original coupé was followed by the inevitable spider convertible, various higher-specification limited edition versions, and a GT3 category racer before production ceased at the end of 2013, by which time the car's name had been shorted to just '12C'.

In 2012 the McLaren MP4-12C was voted 'Best Supercar' and overall 'Car of the Year' at the Middle East Motor Awards, so it is not surprising that many found delighted owners in that part of the world, the example offered here being one such.

Left-hand drive chassis number '830' was delivered new to the GCC (Gulf Co-operation Council) region and is evocatively finished in McLaren Orange, just like the company's early Formula 1 and CanAm cars. Its specification includes the sport exhaust; electrically adjustable and heated seats; parking sensors; tyre pressure monitoring; lithium-ion battery charger; fire extinguisher; car cover; ashtray; and McLaren branded floor mat set. In addition, this car also has the optional upgrades of the carbon fibre interior; lightweight forged wheels; Stealth Pack (blackened finish to the exhaust and air brake); and the important IRIS upgrade to the Meridian infotainment system.

Possessing full McLaren service history, this MP4-12C has covered only some 430 miles and is presented in effectively 'as new' condition. It will have been freshly serviced by McLaren Ascot prior to sale, and is offered with a UK V5C Registration Certificate and all books/tools.

Please be advised that due to the limited number of kilometers recorded on the odometer, this Lot may incur a VAT liability upon registration in any EU country other than the UK.

£100,000 - 150,000

€110,000 - 170,000

347

One Owner and 38 miles from new

2014 MCLAREN P1 COUPÉ

Registration no. LJ15 ROH

Chassis no. SBM12ABB9EW000061

- Petrol/electric hybrid hypercar
- Left-hand drive
- 200mph-plus performance
- Full McLaren service history
- Freshly serviced by McLaren Ascot







Nowadays, in these increasingly environmentally-conscious times, even supercar manufacturers are expected to make at least a cursory nod in the direction of better fuel economy and reduced emissions; hence the arrival of 'hybrid' technology in this previously exclusively fossil-fuels-only sector of the market. This has had the effect of endowing the modern supercar with some 'green' credentials, while at the same time bringing with it a welcome performance boost in the shape of an additional (electric) motor.

McLaren's first offering in this expanding category was the P1, a limited-edition plug-in hybrid coupé that was first shown to the public in 2012 at the Paris Motor Show. Like its conventionally-powered 12C predecessor, the mid-engined P1 used a carbon-fibre combined body tub and roof structure - 'MonoCage' in factory parlance - while retaining the marque's signature dihedral doors that had been a featured of its first road-going supercar: the F1.

A development of the 12C's, the P1's hydro-pneumatic suspension achieved even greater control of the car's roll and ride height. Weight saving had been a major consideration in developing the P1, so there was little in the predominantly carbon fibre cabin that need not have been there.

According to *Autocar* magazine, the seats 'proved particularly comfortable for our testers, all of whom could find an excellent driving position. Customers can choose their preferred seat height at the factory, and the steering wheel (only ever fitted to the left of the cabin) is widely adjustable – manually, of course, like the seat runner, to reduce weight.'

BMW and Mercedes-Benz respectively had supplied engines for the F1 and SLR, but for the 12C, McLaren decided to develop its own. The rights to an Indy Car V8 racing engine were acquired from Tom Walkinshaw Racing, and with assistance of Ricardo this was transformed into a 3.8-litre twin-turbocharged unit suitable for a road car. Manufactured by Ricardo at its Shoreham-by-Sea factory, it was a modified and strengthened development of this M838T engine that was used for the P1, delivering its maximum power output of 727bhp and 531lb/ft of torque via a seven-speed dual-clutch automatic gearbox. Add to that the 176bhp and 192lb/ft of the in-house-developed electric motor, and the P1 had no less than 903bhp and a whopping 723lb/ft of torque at its disposal. 'Maintaining good driveability, given this level of specific output (and this engine... is remarkably docile), is one of McLaren's greatest achievements with this car,' declared *Autocar*.



A high-density lithium-ion battery pack powered the electric motor, which could be left to deploy automatically or selected by the driver, who thus had the options of using the petrol engine on its own, the electric motor on its own, or the two in combination. The battery could be charged by the engine or from the mains, with full charge achieved in two hours.

As one would expect from a manufacturer that has been a mainstay of Formula 1 for the last 50 years, McLaren endowed the P1 with a number of competition-derived high technologies in the form of IPAS (Instant Power Assist System), DRS (Drag Reduction System), and KERS (Kinetic Energy Recovery System). Tested by Autocar, the P1 accelerated to 60mph in 2.8 seconds on its way to a top speed (electronically limited) of 217mph (350km/h), with the standing mile dismissed in 18.2 seconds.

Power reached the ground via bespoke Pirelli P-Zero Corsa tyres, while the carbon-ceramic brakes were claimed to stop the P1 from 186mph (300km/h) in an eyeball-popping 6.6 seconds. And if you wanted anything quicker, only the Bugatti Veyron Super Sport (30 cars built) could deliver.

McLaren unveiled the production version of the P1 at the 2013 Geneva Motor Show, announcing that only 375 of these exclusive hypercars would be built. By the end of the year, the entire production run had sold out. The UK base price was £866,000, though as most customers chose to enhance their car's specification courtesy of McLaren Special Operations' extensive options catalogue, few would have been delivered for less than the equivalent of £1 million.



Chassis number '61' was delivered new to the GCC (Gulf Co-operation Council) region and is finished in striking Volcano Orange livery with numerous carbon fibre embellishments both inside and out. Its specification includes full Alcantara seats; parking sensors; tyre pressure monitoring; fire extinguisher; car cover; ashtray; McLaren branded floor mat set; lightweight forged wheels; Stealth Pack and badge set; and a Meridian surround sound infotainment system.

Possessing full McLaren service history, this gorgeous, rare, and highly desirable P1 has covered only some 38 miles and is presented in effectively 'as new' condition. It will have been freshly serviced by McLaren Ascot prior to sale and is offered with a UK V5C Registration Certificate and all books/tools.

Please be advised that due to the limited number of kilometers recorded on the odometer, this Lot may incur a VAT liability upon registration in any EU country other than the UK.

£1,300,000 - 1,700,000

€1,500,000 - 1,900,000



348

The last 'Super Sport' built

2012 BUGATTI VEYRON SUPER SPORT

Registration no. to be advised

Chassis no. VF9SG252X4M795031

- One owner
- Circa 550 kilometres from new
- Always serviced by Bugatti
- Serviced prior to sale
- Immaculate 'as new' condition
- Unique opportunity

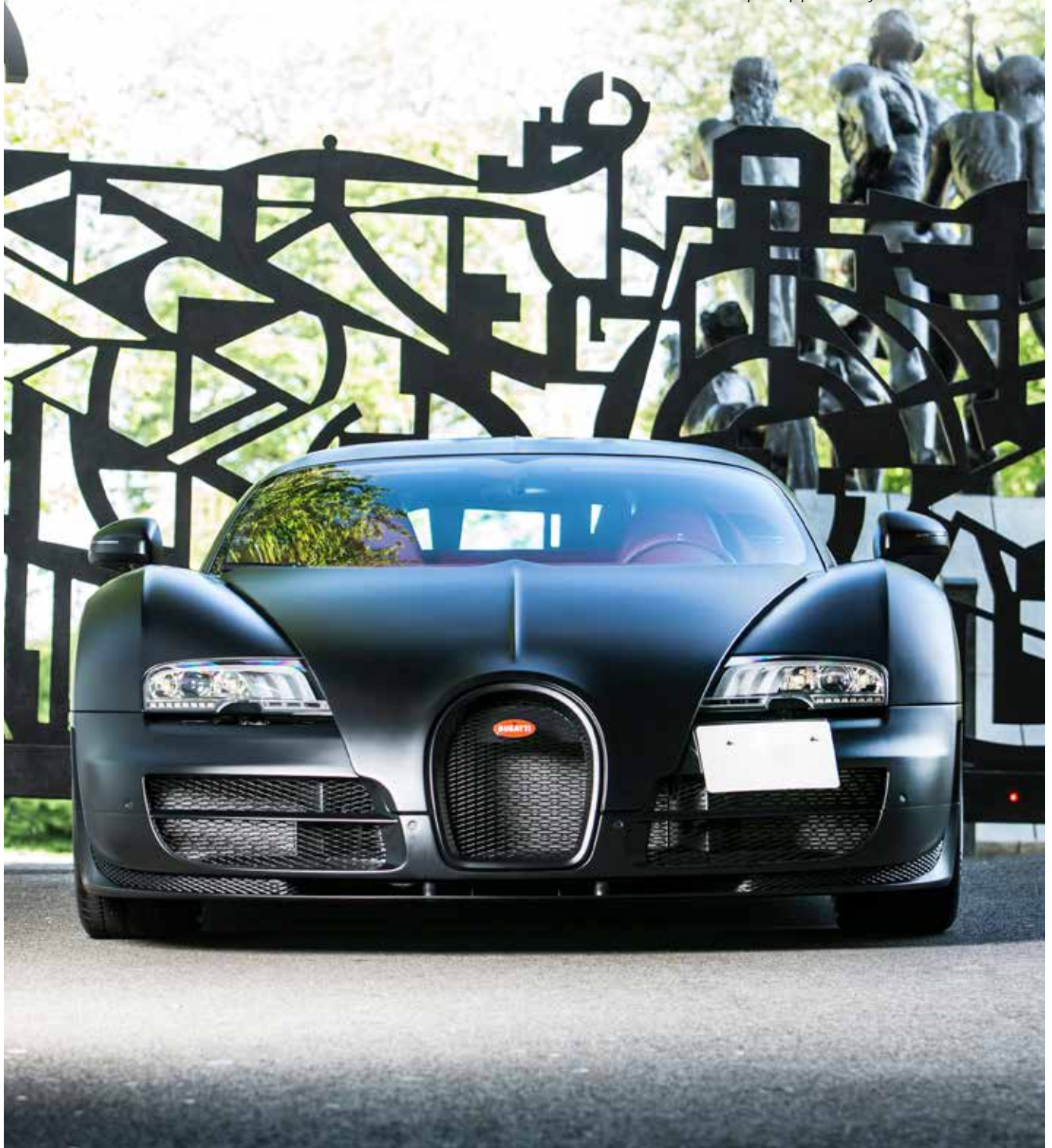



'The Bugatti Veyron has recalibrated that which can be achieved by the motor car.' – *Autocar*.

To say that the Bugatti Veyron caused a sensation when it arrived in 2005 would be a gross understatement; for here was a car that didn't just rewrite the supercar rule book so much as tear it up and start afresh. All the more remarkable was the fact that the Veyron was the dream of one man: Ferdinand Piech, CEO of the Volkswagen Group, which had acquired the Bugatti brand in 1998. Piech's ambition was to create a car that had 1,000 horsepower at its disposal, could exceed 400km/h (250mph), and cost €1 million. Turning Piech's dream into a reality would prove to be an immensely difficult undertaking, even for a company with Volkswagen's technological resources, and the result would not see the light of day for another seven years.

Designed by Italdesign boss Giorgetto Giugiaro, the first concept car – the EB118 – was displayed at the Paris Auto Show in 1998, featuring permanent four-wheel drive and a Volkswagen-designed W18 engine. A handful of variations on the theme were displayed at international motor shows over the course of the next few years before the concept finally crystallised in 2000 in the form of the Veyron EB 16.4. The latter was styled in house at VW by Hartmut Warkuß and featured an engine with 16 cylinders and four turbochargers – hence the '16.4' designation. It was named after Bugatti development engineer and racing driver, Pierre Veyron, who together with co-driver Jean-Pierre Wimille, had won the 1939 Le Mans 24-Hour race for the French manufacturer.

But this was far from the end of the development process, and it would take another five years and an extensive shake-up of the project's management and engineering teams before production could begin, by which time an incredible 95% of components had been either changed or redesigned.

Effectively two narrow-angle 4.0-litre V8 engines sharing a common crankcase, the 8.0-litre W16 – just – met Piech's requirements, producing a maximum output of 1,001PS (987bhp) and 922ft/lb of torque, figures that would embarrass a current Formula 1 car. With a kerb weight of 1,888kg (4,162lb) the Veyron had a staggering power-to-weight ratio of 523bhp per ton.

Tasked with transmitting this formidable force to the ground was a permanent four-wheel-drive, dual-clutch transmission system incorporating a seven-speed paddle-shift semi-automatic gearbox, the latter built by the British company, Ricardo, while to accommodate the Veyron's phenomenal top speed Michelin designed special run-flat PAX tyres. Piech had specified a maximum velocity of 250mph and the Veyron did not disappoint, with more than one tester – *Top Gear*'s James May included – exceeding the target by a few miles per hour. At €1,225,000 (£1,065,000) the Veyron base price as also exceeded Piech's target comfortably.





To maintain stability at such high speeds, the Veyron has a few aerodynamic tricks up its sleeve, a hydraulic system lowering the car at around 140mph, at which speed the rear wing deploys, increasing downforce. But if the Veyron driver wishes to exceed 213mph (343km/h), he or she needs to select Top Speed Mode (from rest) before joining what is a very exclusive club indeed.

Jeremy Clarkson, reviewing the Veyron for *The Times*: 'In a drag race you could let the McLaren (F1) get to 120mph before setting off in the Veyron. And you'd still get to 200mph first. The Bugatti is way, way faster than anything else the roads have seen.' Yet despite its breathtaking performance, the Veyron contrived to be surprisingly docile at 'sensible' speeds. 'Bugatti says the Veyron is as easy to drive as a Bentley, and they're not exaggerating,' declared *Autocar*. 'Immediately you notice how smoothly weighted the steering is, and how calm the ride is.'

In a market sector many of whose protagonists can only be described a 'hard core', the Veyron contrived to be a remarkably civilised conveyance. 'When you climb aboard the Bugatti Veyron there are no particular physical contortions required of you by the world's fastest car, as there are in so many so-called supercars,' observed *Autocar* describing 'the most exquisite car cabin on earth.' The latter was found to be more than generously spacious for a two-seat mid-engined car, while in terms of interior equipment there was virtually no limit to what the, necessarily

wealthy, Veyron customer could specify. Restricted rearward visibility is a frequent bugbear of mid-engined supercars, a problem the Veyron dealt with by means of a reversing camera.

In 2009, an open version of the Veyron – the Grand Sport – was announced, featuring a removable roof panel and 'emergency' soft-top. The following year Bugatti released the ultimate Veyron - the Super Sport - which came with 1,200bhp, 1,100ft/lb of torque, and revised aerodynamics. Only 30 were made, the very last of these truly fabulous cars being that offered here. An open version - the Grand Sport Vitesse - was introduced in 2012.

The SSC Ultimate Aero had taken the Veyron's title of 'World's Fastest Car' in 2007, but the Super Sport would soon put the upstart American manufacturer in its place. The redoubtable James May achieved a top speed of 259.49mph (417.61km/h) on 4th July 2010, and later that same day Bugatti test driver Pierre Henri Raphanel set a new mean best mark of 267.856mph (431.072km/h) at Volkswagen's test track near Wolfsburg in Germany. This had been achieved by deactivating the Super Sport's electronic limiter, which restricts top speed to 'only' 258mph (415km/h), causing some to question the figure's validity. Eventually, the Guinness Book of Records decided that the mark should stand. By the time Veyron production ceased in 2015, Bugatti had built only 450 of these quite extraordinary cars.



Car number '7.031', the historic Bugatti offered here is the very last Veyron Super Sport built and features kick-plates engraved with legend: 'THE LAST SUPER SPORT'. Finished in striking matt black with contrasting red leather interior, the Veyron has had only one owner and has covered circa 550 kilometres from new; always maintained by Bugatti, it will have been serviced prior to sale and is presented in effectively 'as new' condition. Offered with a signed Bugatti Certificate, Configuration Form, and all books and tools, car number '7.031' represents a unique opportunity for the discerning collector to own part of the Veyron legend.

Please be advised that due to the limited number of kilometers recorded on the odometer, this Lot may incur a VAT liability upon registration in any EU country other than the UK.

**£1,700,000 - 1,800,000
€1,900,000 - 2,100,000**





349 Ω N

One owner and 300kms from new

**2011 ASTON MARTIN ONE-77
Q-SERIES COUPÉ**

Registration no. to be advised

Chassis no. SCFGFXXX9BGS17728

- One of 77 built
- The sixth of only seven Q-Series Special Editions
- Left-hand drive
- 'As new' condition
- Freshly serviced prior to sale







'The One-77, a sports car of unparalleled beauty with subtle aggression and performance developed in 2008 and 2009 with the goal of eclipsing any previous Aston Martin road car. The most exclusive Aston Martin of the 'Gaydon era', One-77 was limited to 77 unique examples.' - Aston Martin.

In keeping with its tradition of producing limited edition, hand crafted exotica for the wealthy aficionado, best exemplified by the DB4 GT Zagato of the 1960s, Aston Martin previewed its proposed One-77 'hypercar' at the 2008 Paris Motor Show. 'Previewed' though, is something of an overstatement, as the car remained part shrouded by a grey pinstripe fabric cover, with only the front right corner on view. To see the full picture, the world had to wait until the Geneva Motor Show the following March when the Aston Martin stand featured a metallic blue mock-up alongside a rolling chassis complete with its entire power train.

The finished One-77 made its official debut in April 2009 at the Concorso d'Eleganza Ville d'Este, held on the shores of Lake Como in Italy, winning the 'Award for Concept Cars and Prototypes'.

Designed by Marek Reichman, it was the fastest and most powerful Aston Martin ever built, with a top speed of 220mph, and also the most expensive, carrying a price tag of £1,150,000. The company invited customers to put down a deposit of £200,000 and had no trouble selling all 77 cars, production of which was completed in 2012.

Hailed by its maker as 'possibly the world's most desirable automotive art form', the One-77 with its long bonnet and short tail was every inch the classically proportioned Gran Turismo, combining muscular pugnacity and feline grace in equal measure. A two-seater closed coupé, the One-77 featured advanced technology in the form of an immensely rigid and lightweight carbon fibre monocoque chassis, which carried a seamless body traditionally handcrafted in aluminium. Made from a single sheet of aluminium, each front wing was said to take one craftsman three weeks to produce. Evo magazine succinctly summed it up as 'a masterclass on blending low-tech aluminium forming skills with high-tech carbon fibre technology, and it's shockingly beautiful, making it eye-wateringly desirable.' Other state-of-the-art features included bi-xenon headlamps with integrated LED side lights and direction indicators, LED rear lamps (fog and reverse), carbon fibre front splitters, carbon fibre rear diffuser, and active aerodynamics with deployable spoiler.



Providing the horsepower needed to breach the magic 200mph barrier was a stretched (to 7.3 litres) version of Aston Martin's existing 48-valve V12 engine. Extensively reworked by Cosworth Engineering, it produced 750bhp and 553lb/ft of torque, and was the world's most powerful normally aspirated road-car engine at the time of the One-77's introduction. Cosworth's extensive re-engineering included fitting dry-sump lubrication, which enabled the V12 to be carried 100mm lower in the One-77's chassis than in that of the DB9.

Like the V8 in the One-77's Vantage sister car, the V12 engine was mounted towards the centre of the chassis, well aft of the front axle line in the interests of optimum weight distribution, to which end the six-speed automatic/manual transmission was located at the rear in the form of an integrated transaxle. Power was transmitted to the limited-slip differential by a carbon fibre prop shaft encased in a magnesium alloy torque tube, reaching the road surface via 20" forged alloy wheels - 7-spoke or 10-spoke - shod with Pirelli P Zero Corsa tyres. Unusually for a road car, the One-77's all-independent suspension featured pushrod actuation of the adjustable mono-tube dampers, a system more commonly found in modern competition cars. There were double wishbones at all four corners: the front incorporating anti-dive geometry, and the rear anti-squat and anti-lift. The suspension was also electrically adjustable for both ride height and rate change.

The rack and pinion was power assisted, delivering 3.0 turns lock-to-lock, while the steering column was adjustable for both tilt and reach. Braking was supplied by carbon ceramic discs all round, gripped by six-piston callipers at the front, four-piston callipers at the rear. Dynamic Stability Control (DSC), Anti-lock Braking System (ABS), Electronic Brakeforce Distribution (EBD), Emergency Brake Assist (EBA), and traction control were all incorporated in the interests of controllability and safety.

Releasing the driver's door, which swings out and arcs upwards, the One-77's fortunate owner would be confronted by a leather-trimmed sports steering wheel, electrically adjustable lightweight memory seats, and dual-stage driver/passenger front airbags. Other interior features included automatic temperature control, a trip computer, and touch-sensitive map-reading LED lights. Powerfold exterior memory mirrors came as standard, while front/rear parking cameras were an option. Hypercars though, as their name suggests, are all about performance, and in developing the One-77 Aston Martin ensured that it would be able to stand comparison with the very best of this exalted category.





Perhaps tongue-in-cheek, Aston claimed that the car's top speed was '220.007mph', referencing the company's long-standing association with the 'James Bond' movie franchise, while the dash to 100mph (161km/h) was accomplished in around 6.9 seconds, placing the One-77 on a par with rivals such as the Ferrari Enzo and Koenigsegg CCX. Towards the end of production, Aston Martin announced a special 'Q-Series' version, which took its name from the 'Q by Aston Martin' personalisation programme. Only seven were built, the principal difference between them and the 'ordinary' One-77 being a choice of four special paint/trim combinations.

It had been Aston Martin's intention that no car would be offered for assessment by the motoring press, no doubt in the interests of preserving the One-77's mystique; nevertheless, BBC's *Top Gear* got to try one in Dubai, and *Evo* magazine drove a privately owned example at the Millbrook Proving Ground in Bedfordshire and on the roads of North Wales. *Evo*'s Harry Metcalfe found that controlling the One-77's 750 horsepower on the challenging - and wet - roads of Snowdonia required all of his concentration: 'But boy, does that make this Aston exciting. There's nothing like a car that can spin its wheels in a straight line at beyond motorway speeds to grab your attention.'

Ordered directly from the Aston Martin factory and delivered new to the GCC (Gulf Co-operation Council) region, this One-77 is number '28' of the 77 produced and one of the seven Q-Series cars. The Aston is finished in Morning Frost White with Kestrel Tan interior, while options include the 10-spoke wheels, red brake callipers, Warm Charcoal seatbelts, and a Bang & Olufsen Beosound audio system. Offered with copies of the original manufacturer's Certificate of Origin and sales invoice, the car has covered a mere 300 kilometres since delivery and is presented in effectively 'as new' condition, having been serviced by the factory prior to sale.

Including Aston Martin's development team, a handful of journalists, the original owners and - perhaps - their family and close friends, probably fewer 200 people have ever experienced what it is like to drive a One-77. Chassis number '28' represents possibly once-in-a-lifetime opportunity to join this most select group of individuals.

Please note if the car remains within the EU, VAT at 20% will be added to the hammer price and buyer's premium.

£1,650,000 - 1,800,000

€1,900,000 - 2,100,000

END OF COLLECTION

350 * N

The ex-Henry Adamson,

1928 BUGATTI TYPE 40 GRAND SPORT

Registration no. MW 5884 (see text)

Chassis no. 40796

- *Original UK delivery*
- *Fresh restoration*
- *Exhibited at the Pebble Beach
Concours d'Elegance 2016*
- *Well-documented example*
- *Mille Miglia eligible*



Michael Burns with '40796' at Prescott, 1949





This Bugatti is a rare British supplied example of the sporting and beautifully proportioned Grand Sport, Bugatti's clever 'crossover' factory body that echoed the lines of their hugely successful Grand Prix cars but provided a more commodious four-seater cabin. It was still a spartan design with single access door and compact rear seats and a guise which would prove to be extremely popular, being chosen by a number of clients on cars from the production period encompassing the Type 38 through to the Type 43.

An immaculately restored car, it returns to the UK, for the first time since the War, after a long sojourn in America. The Bugatti order book states that precisely 89 years and one day ago on 12th July 1929, chassis 40796 went to British agent Colonel Sorel, completing an order made in May that year. The car is understood to be one of few of its model that came to the UK, and accordingly historians believe those for this market featured a slight modification for this market in the form of a 'two bow' top mechanism and the option of 'side-curtain' panels to enclose the passengers – presumably necessary for our climate!

Within a few months, Sorel had secured a buyer for the car and it was registered to a G.S. White of Hardenhuish, close to Chippenham, under the Wiltshire number MW 5884, as researched by the current owner from council records. Subsequent ownership is understood to have included a B.J.F. Malcolmson of Sunningdale and London's St. James, followed by a Mr. Kiss, Mr. Vaughan, N. Williams and then R. Godfrey. In the immediate post-war years the car is known to have been active in UK circles, as it is pictured as the 'Clerk of the Course' car at the famed Prescott Hill Climb on 12th June 1949, piloted by a Michael Burns.

Shortly after this it would come through the renowned garage of Jack Lemon Burton, where it would no doubt have rubbed shoulders with numerous of its kind, including its successor in nomenclature, if not in stature, the Type 41 Royale.

By 1958 the car was still here in England, when it was found by an American on his travels, Victor Lane of Chicago at Halfway Garages on Bath Road in Reading. Mr. Lane was extremely fastidious in documenting his ownership and as recounted in a well detailed history file that continues from this point, he states that as bought the Type 40 had been uprated to Type 40A specifications and had recently received an engine rebuild at the hands of Jack Lemon Burton's famed garage in London.



In sales particulars in the 1970s, Lane states that 'Shortly after buying the car, I took it to the Bugatti works in Molsheim.' 'I was greeted enthusiastically and taken for a harrowing road test at once by the shop foreman!' His vivid recollections are carefully noted, and the fact that the foreman gave the car a clean bill of health, with the exception of its starter motor drive, which they quickly fixed for him. By this point it had lost its original steering wheel and he notes 'Francois Seyfried, a company manager, presented me, also without charge, with a brand-new steering wheel'. During this excursion, he learned that the 40A conversion was quite commonplace for the works or national agents to have carried out in period and believed that therefore it had been in this form since the early 1930s.

It is theorised that its numbered crankcase, which is from car 40121, was changed either when the car was updated or during the Lemon Burton rebuild, which is assumed more likely, since a number of these cars passed through that garage and there appears to be a period of crossover of the two cars there.

Between 1959 and 1960, Mr. Lane moved from Chicago to Lincoln, Nebraska and during this period he commenced a restoration of the aesthetically tired, but mechanically sound car. Over the course of his custody for the next 20 years, his use must have been modest as by the time he offered the car for sale in 1978, he notes only 'one or two thousand' miles to have been covered. By then, his career had moved him to work in New York City, and he was resident in Katonah, New York. The buyer in 1978, was one Henry Adamson of Lake Forest, Illinois, a cousin of the famed pioneering collector D. Cameron Peck.

At this point Mr. Adamson began to restore the car, and in his notes on the rebuild, he enthusiastically details his intentions, of repainting, reupholstering etc. As can sometimes happen, decades would elapse before it was completed, and the process became a partnership with the current owner. Working with the now aging Mr. Adamson, the owner vociferously researched the Bugatti to ensure that it was restored in exacting detail. With the goal of a consistent restored presentation, its original interior and roof were replaced, the chassis and body repainted in Bugatti Blue livery and the mechanical aspect carefully worked through and put back to stock Type 40 specifications with a new cylinder block.

Virtually anything that was removed from the car was retained and remaining with it still are the majority of the original leather, seat bases, crankshaft, water pump, the latter mechanical pieces are all stamped with assembly number '23' being believed to be consistent with the engine it was delivered new with, as well as the original floorboards and side screens. (The majority of this accompanies the car today).

Also, on file are a detailed set of photographs, taken during the early days of its restoration/dismantling, all supporting its authenticity and originality. It should be noted that its body number '75' can be found in various locations on the coachwork.

After nearly 40 years the car passed from Henry Adamson into the present owner's hands. On arrival with this Bugattiste, the rebuild was completed in 2016, just in time to be shown at the Pebble Beach Concours d'Elegance, there it completed the Thursday tour, and was displayed on the hallowed 18th Fairway, where it garnered much admiration and the delight of those that had know the car for years that it was finally returned to former glory. Following this, the Type 40 was also used and displayed at the Bugatti gathering at the Greenwich Concours d'Elegance in 2017, winning its class.

Having completed and achieved the journey, but with the car still 'running in' and only modestly used, the owner has elected to pass the car on to another enthusiast to enjoy, and owing its roots chose to bring to the UK for its sale. Here, exquisitely presented this rare British Bugatti is offered for sale nearly 90 years after it left Colonel Sorel's books.

With a fascinating, documented history, the Type 40 offers entry to the esteemed Bugatti Clubs around the world, as well as being on the list of eligibility for numerous other events, including the Mille Miglia.

£300,000 - 350,000

€340,000 - 400,000

Please note that although still wearing cast plates for 'MW 5884', this number is not currently on the DVLA system and would need to be applied for.



351

The ex-Team Lotus, Alan Mann Racing,
Paul Hawkins/Jackie Ickx/Frank Gardner

1967 FORD LOTUS CORTINA MKII COMPETITION SALOON

Registration no. CTC 24E
Chassis no. BA91GD12811

- Original works team car
- Purchased directly from Henry Mann
- Well documented history
- Cosworth BDA engine
- Original competition modifications retained



Paul Hawkins on his way to 4th overall at the Silverstone
Martini International Meet, 1967 © Peter Darley



Frank Gardner pushing through the chicane, Thruxton, 1968





Launched at the 1966 Earls Court Motor Show, the '2nd Generation' Cortina continued the successful collaboration between Ford and Lotus in the form of the Lotus Cortina MkII. But whereas the original had been built by Lotus at Hethel, the new car would be made at Ford's Dagenham works. The mechanical specification continued much as before, though servo-assisted brakes, wider wheels, and the 109bhp Special Equipment engine were now standardised together with the Corsair 2000E gearbox. Available, unlike the MkI, in a full range of colours, the MkII was given an improved interior for 1968, the model name changing to 'Twin Cam' at the same time. A total of 4,032 cars had been made by the time production ceased in September 1970, by which time the Escort Twin Cam and its derivatives had become Ford's frontline competition saloon. As a result, the MkII Lotus Cortina's competition career as a works entry was confined mainly to the 1967 season, the Escort Twin Cam having gained full homologation by May 1968.

Formerly part of Ford's press fleet, 'CTC 24E' is an original Team Lotus car, built at Cheshunt for the 1967 BRSCC Group 5 Saloon Car Championship and powered by a Cosworth-Ford FVA engine. It was raced during the 1967 season by Paul Hawkins and Jacky Ickx, the best results being 1st-in-class finishes at the Silverstone Martini International meeting in May and at Brands Hatch in August.

'CTC 24E' was subsequently acquired by Alan Mann Racing from Brian Robinson, a privateer racer who also owned the sister-car 'CTC 14E' that had been raced by Graham Hill. In fact, Robinson had acquired five Lotus Cortinas directly from Team Lotus: three MkIs and two MkIIs.

Once in Mann's possession, newly engineered chassis/body strengthening and suspension modifications (designed for the Escort Twin-Cam) were incorporated. Designed by Len Bailey and Alan Mann, these chassis and suspension upgrades proved highly successful and are retained in the car today.

Newly prepared, 'CTC 24E' was raced extensively during 1968 in both the European Touring Car Championship and the British Saloon Car Championship by Frank Gardner, whose best results were an overall win at Aspern, Austria and a 1st-in-class finish at Thruxton. The original Ford-owned Cosworth FVA engine was removed in period, and the car was later fitted with a Lotus Twin-Cam and a Ford V6 over the intervening years when it was used in hill climbs and sprints by various private owners. Installed during the last restoration, the current engine is a 1.6-litre Cosworth BDA producing around 200bhp. A five-speed Hewland gearbox, Salisbury limited-slip differential, and a single-piece prop-shaft complete the current drive train specification.

Purchased directly from Henry Mann by the last owner, 'CTC 24E' retains its original 1967 Team Lotus bodyshell modified in period by Alan Mann Racing and retaining AMR's all-important chassis, suspension, and body modifications. An extremely well known and important Lotus Cortina MkII competition saloon, it comes with a history file containing restoration invoices, current MoT, a V5C Registration Certificate, and the original green logbook recording the Ford Motor Company Limited of Warley, Essex as first owners.

£100,000 - 150,000
€110,000 - 170,000

*The ex-Scuderia Ferrari, ex-Richard-Shuttleworth
1935 Donington Grand Prix-winning*

1932-34 ALFA ROMEO TIPO B MONOPOSTO GRAND PRIX RACING SINGLE-SEATER/ROAD-GOING TWO-SEATER

Registration no. MPH 374
Chassis no. '50007' (see text)

Among the myriad great names of British motor racing history, that of Richard Ormonde Shuttleworth is equally well known today within both historic aviation and international motor racing circles. This is thanks largely to the Shuttleworth Collection of historic aircraft, with its motor vehicles as a subsidiary feature, which commemorates this great enthusiast and sportsman, more than 75 years after his death flying with the Royal Air Force in 1940.

Having learned the motor racing ropes most notably in a Bugatti Type 51, Richard Shuttleworth purchased this particular Alfa Romeo *Tipo B Monoposto* for the 1935 racing season, directly from the *Scuderia Ferrari* quasi-works team at Modena, Italy.

Leading Alfa Romeo authority Simon Moore validates this wonderful car most unequivocally in his definitive book, *'The Magnificent Monopostos'*, listing its racing appearances in Richard Shuttleworth's hands as follows:

- One of the most important designs in Grand Prix racing history
- Purchased from the Scuderia Ferrari by Richard Shuttleworth
- Converted to a road car in the 1940s
- The ultimate pre-War road car
- Present ownership for circa 30 years
- Worthy of a place in the finest car collection

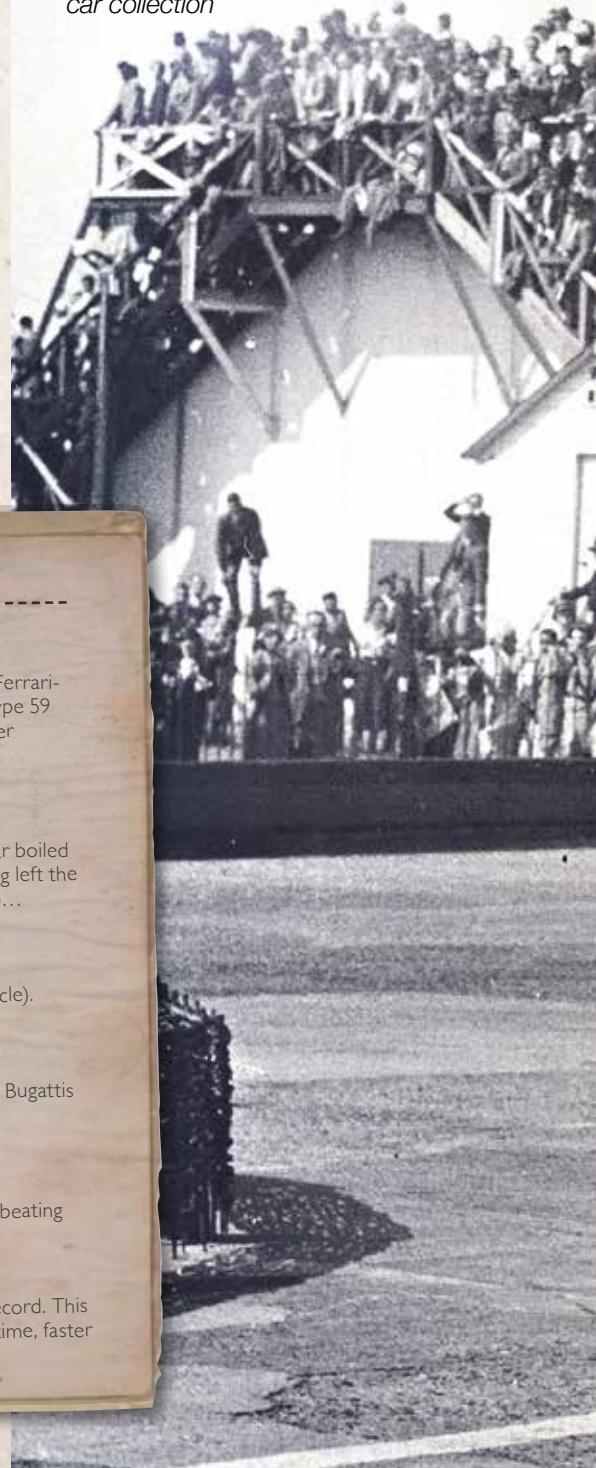

1935 Richard Shuttleworth's Racing appearances

Date

Venue Result

March 16

Brooklands Mountain Handicap, Brooklands
Retired.

April 13

Donington Park, Donington
First in a handicap race. Retired from a second race.

April 22

Brooklands Mountain Circuit, Brooklands
First in Heat. Retired from Final

May 6

Brooklands International Trophy, Brooklands
Fourth

May 18

Shelsley Walsh hill-climb
First in class

May 31

Mannin Moar race, Douglas, Isle of Man
Retired with transmission trouble after leading the first 13 laps of scheduled 50.

July 21

Dieppe Grand Prix, France
Finished Fourth behind the two Scuderia Ferrari-entered sister cars and Wimille's works Type 59 Bugatti, ahead of Farina's 3.4 litre 6-cylinder Maserati 6C-34.

August 13

Nice Grand Prix, France
Retired 11 laps from the finish after the car boiled dry due to Shuttleworth's mechanic having left the radiator cap unclipped at the final pit stop...

September 4

Brighton Speed Trials, Brighton
Fastest car (though beaten by a motor-cycle).

October 5

The Donington Grand Prix, Donington
First, ahead of the two ex-works Type 59 Bugattis of Lord Howe and Charlie Martin.

October 19

Mountain Championship, Brooklands
Won the Mountain Championship, again beating Charlie Martin's Type 59 Bugatti.

November 17

Brooklands The Mountain Circuit lap record. This stood as the 2-3 litre class record for all time, faster than various Maseratis.

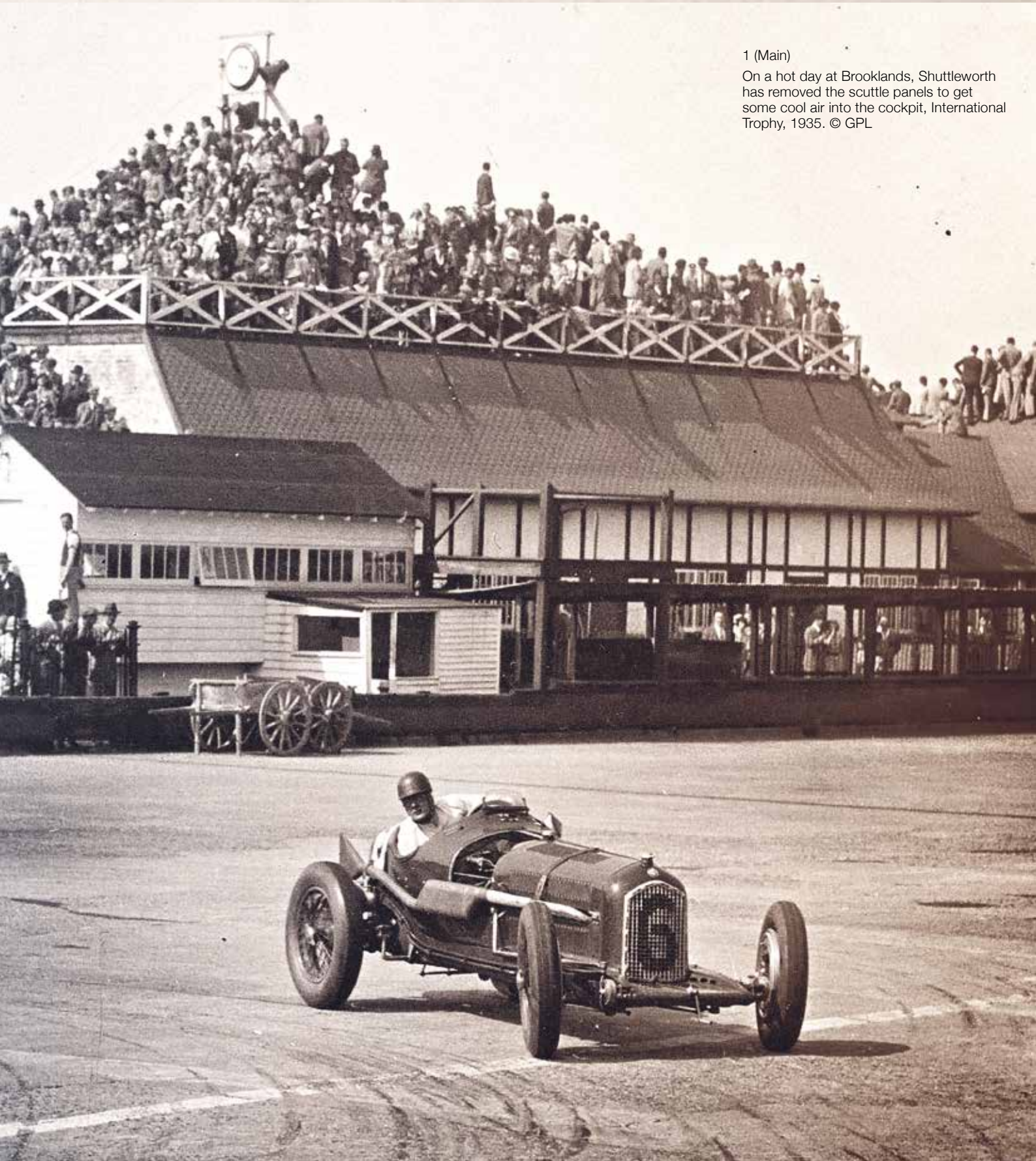

1 (Main)

On a hot day at Brooklands, Shuttleworth has removed the scuttle panels to get some cool air into the cockpit, International Trophy, 1935. © GPL



2 (Main)
Shuttleworth leading top Continental drivers
'Raph' and Rene Dreyfus in their *Tipo Bs*,
Dieppe Grand Prix, 1935.
© Spitzley Zagari Archive

3
Charles Brackenbury behind the wheel shortly
after '5007' was converted to 2-seater form,
1940s. © LAT

4, 5 & 6
'5007' as photographed by
'Motor Sport', 1940s. © LAT

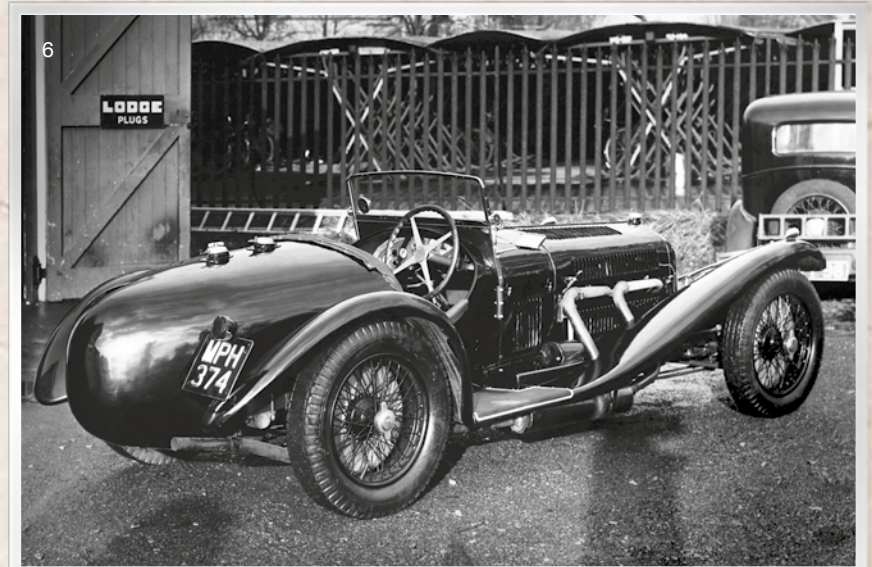
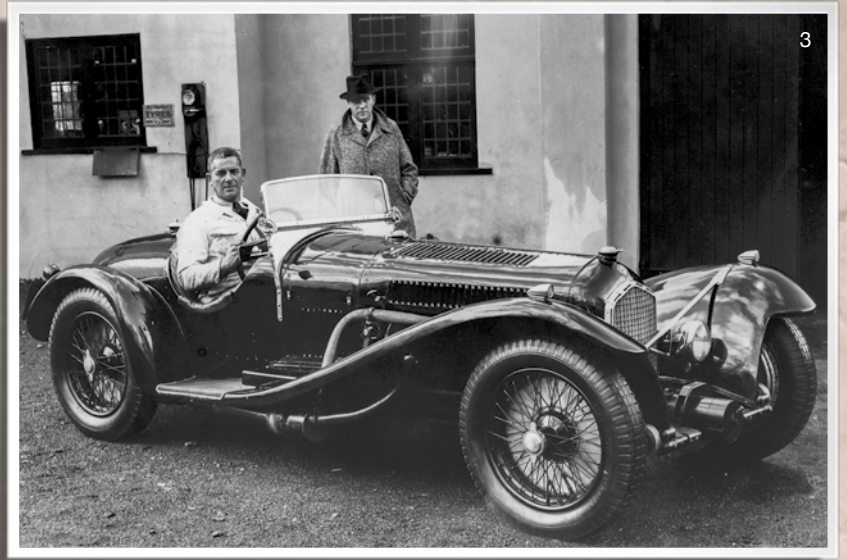

It is also worth emphasising that Shuttleworth's Mountain Circuit lap record with the car was set in the face of ferocious opposition from all the other *Tipo B* Alfas competing at Brooklands up to its closure in 1939, including such very fine drivers as Charlie Martin and Chris Staniland in well prepared cars.

But Richard Shuttleworth's great road racing victory in the inaugural Donington Grand Prix would become this particular *Tipo B* Monoposto's most enduring achievement.

Derby & District Motor Club Secretary Fred Craner had been the practical-minded, no-nonsense promoter and organiser of racing at the Donington Park racing circuit on England's Derbyshire/Leicestershire border. He had long been unhappy with the kind of short-distance races commonly sanctioned by the extremely conservative Royal Automobile Club, and wanted to run a full Grand Prix-distance race such as those common in Continental Europe. His inaugural Donington Grand Prix followed at the picturesque Park, and following his experience of such "serious" road racing at Dieppe and Nice in France, Richard Shuttleworth was among the British amateur gentleman drivers immensely keen to take part. Here was a challenge into which they could really sink their teeth.

'Mad Jack' Shuttleworth - as he was nicknamed after having crashed into the pits at the Isle of Man - certainly made the most of his opportunity in this Alfa Romeo *Monoposto*. He started the 300-mile race facing such "Continental cracks" as Frenchman Raymond Sommer in a sister Alfa *Tipo B* and 'Nino' Farina in a works-backed Maserati V8-R1. Farina led until a Maserati driveshaft failed, and Sommer then took over until a stop to replace his British-regulation bonnet strap (not required in Continental racing, as Sommer heatedly protested), after which he suffered a terminal drive-shaft failure.

British owner-driver Charlie Martin in his ex-works Bugatti Type 59 then inherited the lead, only to try too hard to hold off Shuttleworth despite fading brakes and slide off the road, leaving victory to 'Mad Jack' in his spectacularly-driven Alfa Romeo, which had also spent some time exploring the grass verges of the park rather than staying strictly upon the asphalt.

The contemporary report in *'Motor Sport'* magazine declared: "At last the ambition of the Donington organisers has been achieved, and a 300 mile race run under Grand Prix rules (has been) run off on England's only road-circuit. It was a most successful affair from every angle except that of the weather, for which Mr Craner and his staff of helpers could hardly be blamed. Even the wet roads were not without their uses, as they prevented higher speeds being attained, so that there were no less than nine out of fifteen cars still running at the finish.





THE ALFA ROMEO TIPO B MONOPOSTO'S PLACE IN GRAND PRIX HISTORY

It can justifiably be claimed that there is no more significant Grand Prix car in the history of international road racing at the highest level than the Alfa Romeo *Tipo B Monoposto*.

While, apart from within American speedway racing from 1923, there were very few preceding racing car designs featuring a centreline driving position and single seat for unaccompanied driver, plus exposed wheels unprotected by mudguards or wings – it was the *Tipo B* in its debut season of 1932 that became the first successful centre-seat monoposto Grand Prix car.

The classical Italian design thereby established the classical form of the Grand Prix car, and latterly the Formula 1 racing car, which has come down to us today – not merely within the premier class but also within minor Formulae upon which the world's budding racing drivers have cut their teeth and have learned their craft.

Alfa Romeo technical director, Vittorio Jano, first produced a centreline single-seater for Grand Prix racing with his *Tipo A Monoposto* design of 1931. But that model proved a demanding beast, powered as it was by two parallel 6C-1750 6-cylinder inline engines, each one driving via a separate gearbox to a single rear wheel via an individual propeller shaft. The cars won the *Coppa Acerbo* road race at Pescara, but that was a long way from establishing Grand Prix domination, as Jano's smaller, lighter, more svelte – and single-engined – *Tipo B* replacement would achieve come 1932.

New regulations dropped the old insistence upon two-seat-wide bodywork for Grand Prix racing cars, and Jano was free to perfect his *Tipo B* as a true *Monoposto*, initially built as narrow as could be within the constraint of accommodating a full-size grown man and all normal mechanical assemblies within its chassis and body panelling. Jano developed a full-house Grand Prix racing version of his already very-successful, straight-8, twin-overhead-camshaft supercharged 8C-2300 engine. He retained the 65mm bore size of the 2300 unit but stretched the stroke dimension from 88mm to 100mm for a swept volume of 2,654cc. With around 10.6lbs per square inch boost, Alfa Romeo claimed 215bhp at 5,600rpm.

This engine drove via a gearbox mounted in unit with the engine, while the output end of the gearbox carried a differential mechanism from which a vee-drive splayed rearwards to an individual bevel box driving each rear wheel. The two rear hubs were linked by a lightweight axle tube, and the vee-drive system minimised unsprung weight and removed the tendency a live-axle with centreline crown wheel-and-pinion has of lifting the inside rear-wheel while cornering under power.

This improved tyre adhesion and traction, and proved most effective in service. The left-side bevel-drive housing on the *Tipo B* offered here bears the stamped inscription '*Nurburg*' denoting what was once the installed gear ratio.

The *Tipo B Monoposto* cars were manufactured originally by Alfa Romeo at Portello, Milan, in two batches in 1932-33, each of six individual cars, while the *Scuderia Ferrari* in Modena in combination with Portello produced one extra car – ostensibly the individual now offered here – from available parts, making 13 in all. Engine size was enlarged progressively to 2.9-litres for 1934, and to 3,165cc or 3.2-litres.

When new in 1932, the original slimline *Tipo B Monoposto* weighed only 700kg – 1,543lbs – and Tazio Nuvolari promptly won the Italian and French Grand Prix races, plus the *Coppa Principe di Piemonte*, the *Coppa Acerbo* and *Coppa Ciano* races, while works Alfa Romeo teammate Rudi Caracciola won both the German and Monza Autodrome GPs. When the Alfa Romeo company was taken into Government administration in 1933, and was forced to abandon direct involvement with racing, *Scuderia Ferrari* was entrusted with the *Tipo B* armoury. The cars promptly won no fewer than six of seven major races that late-season as Luigi Fagioli drove to victory in the *Coppa Acerbo*, and Italian and Comminges GPs, and Louis Chiron in the Marseilles, Masaryk and Spanish GPs, while Count Carlo Felice Trossi won the frontline Susa-Monteceneri mountain climb.

Into 1934 the *Tipo B Monoposto* cars were up-rated for the new 750 kilogramme – 1,650lbs – maximum-weight Grand Prix formula, one of whose subsidiary requirements was for minimum 85cm – 33.5-inch – wide bodywork at the cockpit. This is the form in which '5007/50007' is now offered here.

Into the *Tipo B Monoposto* cars' final frontline season of 1935, at least another 16 victories were achieved by the cars – mostly at secondary level – although Count Antonio Brivio won the Targa Florio, Carlo Pintacuda/Marchese Della Stufa won the Mille Miglia in a *Biposto* conversion of a *Tipo B*, and Tazio Nuvolari most famously defeated the massively-capable new German teams of Auto Union and Mercedes-Benz in their own national Grand Prix at the Nürburgring.

Indeed, over four tumultuous frontline racing seasons, *Alfa Romeo's Tipo B* had established itself as the standard-setting design to beat – fully justifying the reverent respect which the surviving cars have commanded amongst enthusiasts ever since.

"Foreign cars and drivers always add to the interest of a race over here, and for once all three whose names appeared on the programme did actually take part in the race. Farina was at the wheel of a 4.5 Maserati, the new V8-cylinder car, his partner Rovere had brought a 6-cylinder 3.7-litre car, the one which Nuvolari drove last year, while Raymond Sommer, twice victor of Le Mans, was seen on the 3-litre Alfa-Romeo which he drove so successfully at Comminges..."

The report continued "It was a splendid sight to see in England...the Union Jack was raised, and the exhaust notes of the cars mounted to a culminating pitch, followed by a headlong rush for the first corner at Old Starkey's. Farina got there a car's length ahead, with Shuttleworth and Sommer jostling for second position... Farina's Maserati in a single lap gained eighty yards on Sommer, while Shuttleworth on the green Alfa was some fifty yards to the rear. Shuttleworth found the French-owned Alfa a little too quick for him, and lost ground each lap."

Shuttleworth's great friend and rival Charlie Martin rushed into contention in his Bugatti Type 59: "Martin took fourth place, but a few laps later braked heavily when in hot pursuit of Shuttleworth, and spun right round at Starkey's Corner. On the thirty-fourth lap Shuttleworth came roaring down to Starkey's Corner in company with ' Bira ' on the ERA.

He found, that the latter, whose car bore the legend ' Siam ' in large letters, had no intention of giving way, and had no option but to charge straight on to the grass, just pulling up in time to avoid hitting the bank. He came into the pits two laps later to enter a protest, but the only result of this was that he lost third place to Charlie Martin on the 3.3 Bugatti.

"Farina was reported as having stopped near McLean's Corner with a broken half-shaft in the back-axle...Sommer moved into the lead, and at 50 laps C. E. C. Martin (3.3-litre Bugatti) was second, 1 minute 40 seconds behind, and Lord Howe on a similar car was only 10 seconds in the rear. Shuttleworth who was fourth was within four lengths of being lapped by Sommer, but now decided the time had come to make a stand..."

"The two Alfas were perfectly matched and after a time the English driver widened the gap to forty yards. This contest was ended by Shuttleworth having a terrific skid at the hairpin corner shooting up the bank, and Sommer was past before he got back on to the road.

"On his fifty-ninth lap Sommer came into the pits, and besides refuelling changed all eight plugs, possibly as a result of his duel with Shuttleworth. This stop cost him over 3 minutes and so Martin passed into the lead, having completed 60 laps at a speed of 66.04 m.p.h. Lord Howe then came in and Shuttleworth jumped up into second place.





"Sommer set off again with renewed speed and at the sixty-fifth lap had pulled up to second place. Shuttleworth refuelled and adjusted his brakes all in the record time of 1 minute 10 seconds, but his stop pulled him back to fourth. Just as Sommer looked like catching Martin, his bonnet strap broke and he was flagged into the pits to remove it, and again four laps later to fit another one in its place. These delays so infuriated Sommer (bonnet straps are not compulsory on the Continent) that he lost all restraint and started to overdrive the Alfa Romeo, and on the seventieth lap came slowly into the pits — another broken halfshaft. Sommer kicked the offending bonnet strap and left the course.

"This left Martin in the lead, while Everitt (Gino Rovere's Maserati) now lay second. (But) with a hundred laps completed the order was Martin, Shuttleworth, Lord Howe and Everitt. Martin was due to call at his pit for a small quantity of fuel and at lap 104 a mechanic hung out a board marked 'In'. Next lap the car pulled in and eight gallons of fuel was dumped in, in a twinkling.

"A win for the Bugatti seemed a foregone conclusion but next time round No. 2 failed to appear...he had gone off the road at McLean's Corner and was unable to re-start. Officials came to his rescue and gave him a push, but with only ten laps to go it was obviously impossible to catch Shuttleworth or Howe.

"Lord Howe made great efforts to catch Shuttleworth, whose brakes were not functioning too well, but the Alfa, managed to get home with less than a minute to spare. It was a splendid finish after three hundred miles of fine driving..."

As the British and European race season had ended, a select group of British racing regulars then shipped their cars to contest the 1936 South African Grand Prix at East London. The 12-mile Prince George Circuit lay some five miles south west of the Indian Ocean port city. Racing driver T. P. Cholmondeley-Tapper recalled: "The race over eighteen laps was to be a handicap event, apart from the orthodox racing cars to be driven by Wimille and our party, which now included Richard Shuttleworth who had arrived by Imperial Airways and was to drive his new Monoposto Alfa Romeo, the entries consisted of hotted-up production cars, many of them American models..."

Bugatti star driver Jean-Pierre Wimille's Type 59 started on scratch. Tapper continued: "As I completed my first lap and came in view of the starting straight, I saw Shuttleworth in his new *Monoposto* Alfa Romeo and Wimille with the Bugatti works entry beginning the race, and they were the only cars I saw for some time, for with the long circuit and wide diversity in the performance of entries, it was a lonely race..."



5
Donington Park was somewhat rustic in 1935! Shuttleworth powers through Coppice Farmyard. © GPL

6 (Main)
Shuttleworth leading the Mannin Moar, Douglas, Isle of Man, clearly a warm day again since scuttle panels have been removed, 1935. © LAT

7
Shuttleworth shields his mechanic from the rain, as final checks are made to the car, Donington Grand Prix, 1935. © LAT





8
Shuttleworth dicing hard with Earl Howe in his Type 59 Bugatti - two of the greatest classical Grand Prix cars together, Donington, 1935. © LAT

9 (Main)
On his way to winning the Donington Grand Prix 'Mad Jack' Shuttleworth explored the limits of the track and beyond, here followed by a rather more circumspect Charlie Martin, 1935. © LAT

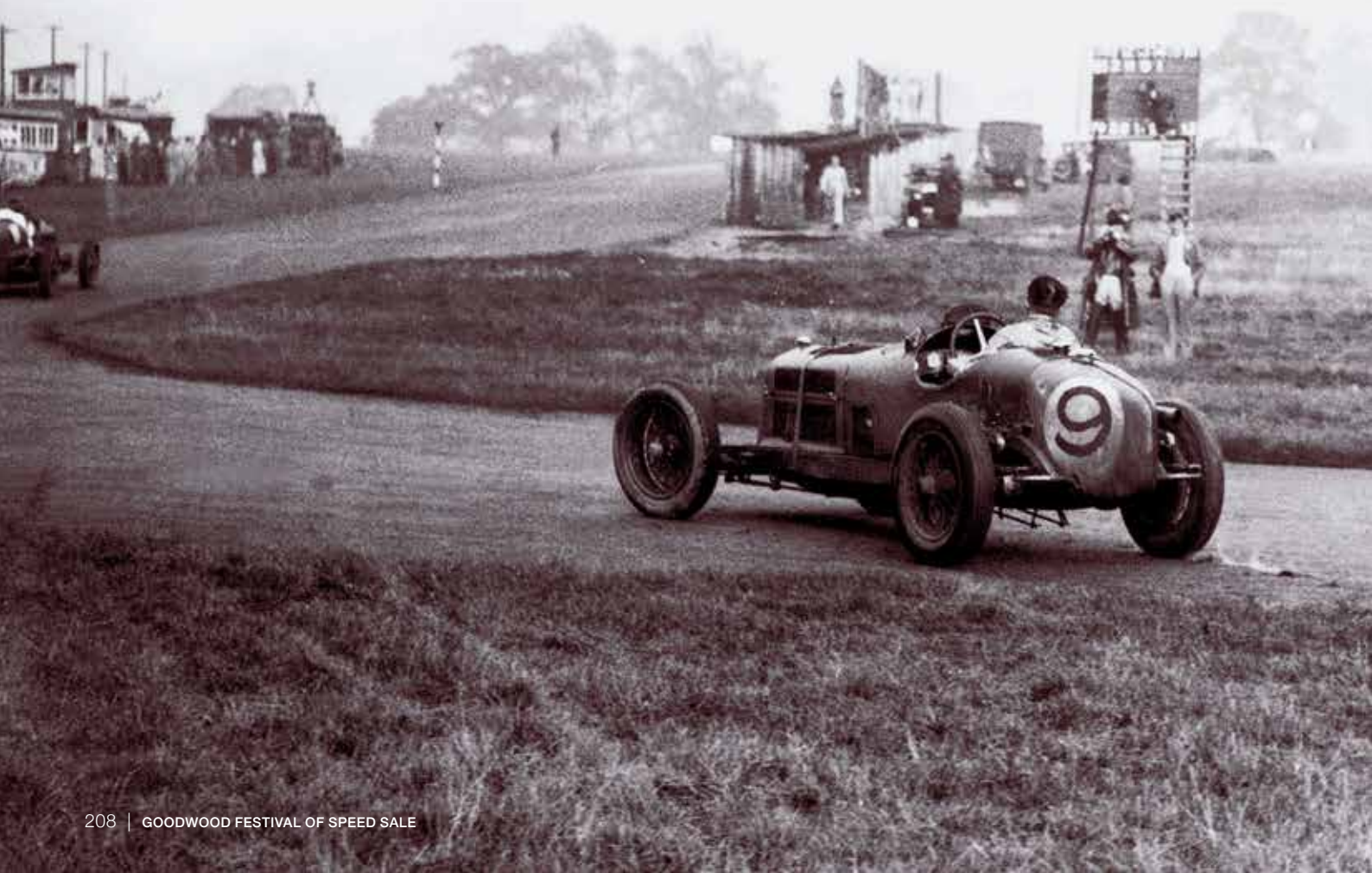

10

Shuttleworth winning the Donington Grand Prix after a hard fought and breathless 300 miles of racing, 1935.
© LAT

10

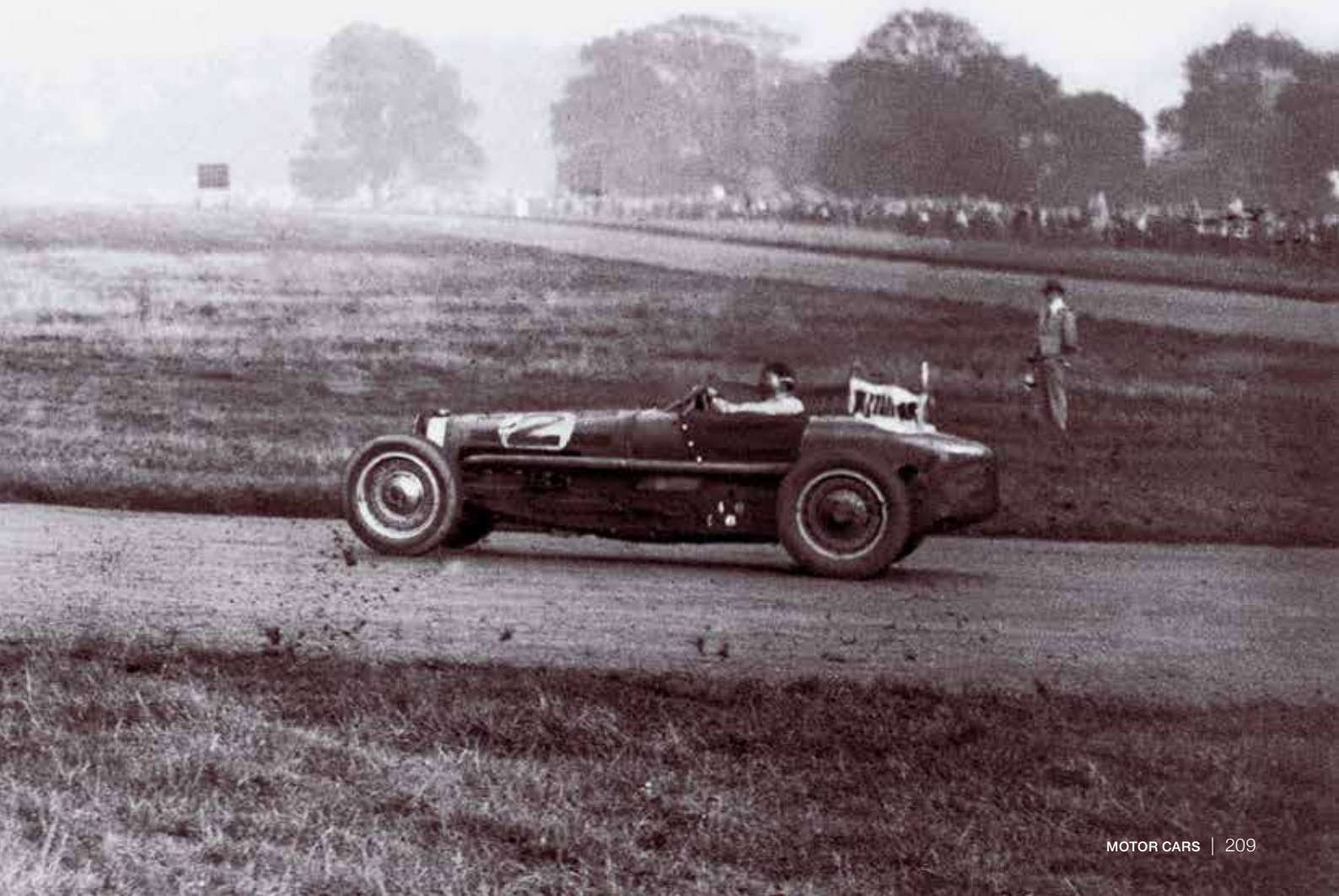

However, when travelling at high speed on the coastal section, a gale-strength crosswind gusting off the Ocean and blasting through a gap in the flanking vegetation caused Shuttleworth to lose control of his *Monoposto*, which dashed into the roadside scrub, tripped, and somersaulted, throwing him out to sustain serious head and leg injuries...

Tapper again: "Several days later when he regained consciousness, Shuttleworth told me that he vividly remembered being thrown high into the air and having a long, long way to fall before hitting the ground...". Tapper and fellow British racing driver Arthur Dobson contacted South Africa's leading head-injury specialist, 700 miles away in Johannesburg, "...who chartered an aircraft for himself, his assistants and equipment, and we waited anxiously for the early evening when he was due to arrive (but) engine trouble had forced their plane down some miles north of East London and that he had completed the journey by car. He accompanied me straight away to the hospital, and was successful in bringing Shuttleworth round for the first time since his crash..."

After many months' recovery, Richard Shuttleworth had his crash-damaged *Monoposto* returned from South Africa to the *Scuderia Ferrari* workshops in Modena where he had it rebuilt during the winter of 1938-39.

Some new or low-usage spare parts replaced damaged components, and the car has come down to us today with its frame stamped in the correct rear-end location with the *Scuderia Ferrari* vehicle number '49'. It is possible that the team mechanics used an immediately available spare chassis in the repair, or the structure surviving within the car today may well in fact have been the original dating from 1934 and straightened-out.

While first-series *Tipo B* cars were identified by four-digit chassis numbers, second-series cars had five-digit serials applied. Simon Moore explores the car's early provenance like this in his wonderful book, *The Magnificent Monopostos* — writing: "In early 1935, Richard Shuttleworth appeared with a *Tipo B*, painted green. Since it must have been a first series car...I have covered the car here" — as chassis serial '5007' although "...the car has a plate giving '50007' as the chassis number today.

"The car (when acquired by Shuttleworth) had the later 1934-style body (with blowers covered) and twin oil lines..." — and Simon suspects that "...it is possible that this was the car built up by Guidotti in early 1934 from parts at Alfa Romeo and fitted with a streamlined body for AVUS" — the speedway-style AVUS-Rennen race in Berlin, Germany in which the Italian team would confront the newly-introduced state-backed teams from Auto Union and Mercedes-Benz.



11
 '5007' as illustrated in the programme for the 1936 South African Grand Prix
 © Frank Hoal Collection

12
 The 1936 South African Grand Prix would end in a heavy crash for Richard Shuttleworth, his linen wind-cap providing little protection as the Alfa Romeo pitch-poled off circuit at very high speed. The car would be rebuilt by the Scuderia Ferrari in 1938-39.
 © Frank Hoal Collection



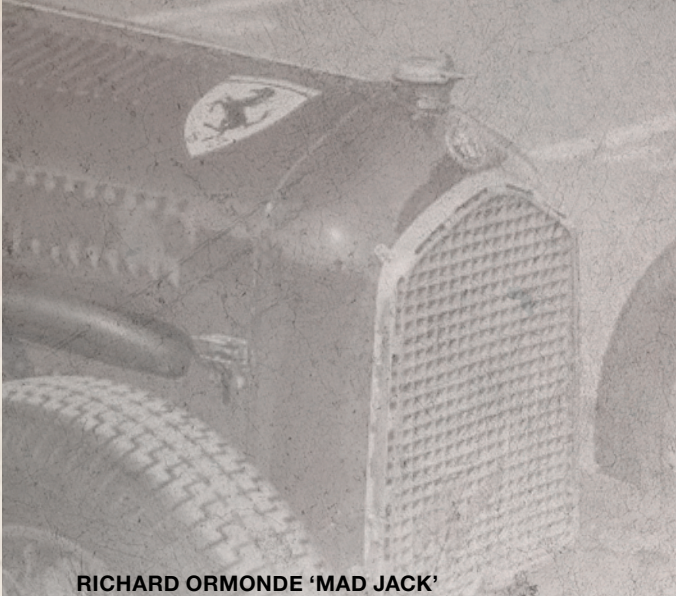

**RICHARD ORMONDE 'MAD JACK'
SHUTTLEWORTH 1909-1940**

The winner of the inaugural Donington Grand Prix in the Alfa Romeo *Tipo B* Monoposto now offered here was born on July 16, 1909, at the Old Warden country estate in Bedfordshire. Old Warden Manor House was built in 1872, and the Shuttleworth family wealth came from the long-established firm of Clayton & Shuttleworth, agricultural engineers and steam-wagon makers based at the Stamp End Works in Lincoln.

Richard Shuttleworth was an only child, and when he had been born his father - Colonel Frank Shuttleworth - was already in his sixties. The Colonel - who in his time had been a British Army career officer, a daring steeplechase jockey, horse breeder and industrialist - died when Richard was just four years old. Upon his 23rd birthday, the boy inherited a considerable fortune that he promptly deployed to indulge his triple passions for motor racing, aviation, and historic engineering.

A keen and capable horseman, Richard Shuttleworth was one of the first great enthusiasts to appreciate early horseless carriage motor vehicles. He bought his first veteran car, an 1898 Panhard Levassor, which had previously competed in the Paris-Amsterdam city-to-city race, and drove it enthusiastically in the London-to-Brighton Run. He also bought his first aircraft, the De Havilland DH60X Moth (registered 'G-EBWD'), and both car and aeroplane are still preserved today within the enduring Shuttleworth Collection that commemorates his name.

Educated at Eton, and after service as an officer in the British Army, the young man concentrated upon running his family's Old Warden Park estate, while his newly-released wealth also allowed him to indulge his growing passions for flying and motor racing.

He raced a Bugatti Type 51 at Brooklands for the first time in 1932, finishing third in the Mountain Championship and winning the Hereford Lightning Long Handicap. He was a popular and competitive driver and his often lurid cornering style earned him the, albeit somewhat exaggerated, nickname 'Mad Jack'.



Richard Shuttleworth became a regular upon the British road-racing scene, often flying himself to events in his DH Moth or in one or other of his two Desoutter monoplanes. He was particularly active in the Alfa Romeo *Tipo B* Monoposto, which he bought for the 1935 season direct from the *Scuderia Ferrari* quasi-works team in Modena, Italy, and he achieved his greatest success in this car by winning the first full-distance 'British Grand Prix' race of the period, the 1935 Donington Grand Prix at Donington Park in Derbyshire.

He then shipped the winning car south for a Christmas-tide trip to compete in the International South African Grand Prix at East London, overlooking the Indian Ocean. However, he lost control of this very fast Alfa Romeo while near maximum speed along the seaside straight. Shuttleworth did not return to England until April that year, some four months after the accident, and he would not race again.

Richard Shuttleworth was a fit and rugged young man, and he recovered impressively well, concentrating his interest upon aeronautics and upon what - even in the late 1930s - were historic aircraft. He assiduously hunted out abandoned early aeroplanes, and had them restored to pristine flying condition.

When World War 2 erupted in September 1939, Richard Ormonde Shuttleworth quickly joined the Royal Air Force and was posted to RAF Benson. In the early hours of 2nd August 1940, he had just taken off on a cross-country training exercise in a Fairey Battle single-engined bomber when it crashed into a hill at nearby Ewelme, Oxfordshire, and he was killed.

His widowed mother, Dorothy, kept the Shuttleworth Collection alive in his memory. Despite his early and untimely death, the legacy of Shuttleworth's passion and enthusiasm for restoring marvellous old vehicles and aircraft to their former glory, to be enjoyed by later generations, lives on today at Old Warden - and within the fabric of his Donington Grand Prix-winning Alfa Romeo.

The *Scuderia Ferrari*'s new star driver – Algerian Guy Moll – dashing defeated the Auto Unions and won the AVUS race in that Pallavicino-bodied streamlined *Tipo B*, which may have come down to us as the car offered right here: ex-*Scuderia Ferrari*, ex-Richard Shuttleworth. The possibility is that the Pallavicino-bodied chassis was reworked with standard 1934 750kg Formula Grand Prix bodywork, and was then the car driven by Guy Moll when he crashed during that year's Coppa Acerbo road race at Pescara. The damaged car would then have been rebuilt for sale to one of the several importunate would-be customers queuing up at the *Scuderia Ferrari*'s front door in Modena, eager to buy... in this case, the wealthy, enthusiastic and capable young Englishman, Richard Shuttleworth.

Simon Moore: "The AVUS streamliner was seemingly rebuilt with a 'normal' body and used during the rest of the season – and 'normal' by mid-1934 would have meant a wide body, twin oil line, second series type. It..." – referring to the car as purchased by Shuttleworth – "...was also rumoured to have been rebuilt from the car wrecked by Guy Moll at the Coppa Acerbo" (at Pescara, in poor Moll's fatal accident), which was fitted with a second-series body – which is not inconsistent with it (also being the AVUS car rebodied..."

But Simon Moore emphasises: "...we will never know for certain". He also assessed the car's numerical identity as stamped into the metal today, as follows: "Despite the uncertainty about the original chassis number of this car, it has a long and continuous history and is a lovely *Tipo B*. Since it must have been a first series car – numbers 5001 to 5006 ... – I have covered the car here as chassis serial '5007'. He continued "That assumption as to the number may be incorrect and the car has a plate giving 50007 as the chassis number today – incorrectly". Moore goes on to speculate that the car was re-numbered 50007 either as an in-period customs dodge for bringing it in and out of the UK for the *Scuderia Ferrari* post-accident rebuild, since 50007 was already in the UK having been imported with duty paid by Lemon Burton in 1938. Or possibly because the mechanics that rebuilt it at *Scuderia Ferrari* did not understand the first series numbering system, thought the plate on the car saying 5007 was erroneous and fitted a new one with what they believed to be its correct number.

The frame also has a five-digit number (52002) stamped at the front... which would also indicate a second series frame, although most of the mechanical parts are stamped with first series *Scuderia Ferrari* numbers..."





This rebuilt *Tipo B* was not used again by Richard Shuttleworth before the outbreak of World War 2 and his accidental death while flying in the RAF in 1940. His mother finally sold the car post-war to Geoffrey Barnard, perhaps via Brooklands star Charles Brackenbury. In the late 1940s it was converted in British specialist Vic Derrington's Kingston-upon-Thames workshop into a two-seat sports car for high-performance road use, as Scuderia Ferrari had done with a *Tipo B* pre-war to dominate the Mille Miglia. Geoffrey Barnard then used it on the road for several years with the two-seater body fitted, and it featured in several magazine road tests and comments columns.

Bill Boddy of *'Motor Sport'* magazine was one who experienced the great car, commenting: "As impressive as its urge was its docility, running at 1,200 rpm in top gear, being snatch-free and not seeming to foul the sparking plugs of the straight-eight engine. Another surprise - we were on Pool petrol and ignition advance and retard is automatic, yet no under-bonnet distress signals were evident. This one-time Monoposto is perfectly gentlemanly in English built-up areas!".

He concluded: "...without closely approaching peak rpm, something like 118-120mph should show up. Whoever acquires this 'P3' will have a road car in a category shared by only about half-a-dozen others, all of them built pre-war, cars of which the appeal is as much bound up with perfection of character as with the stupendous performance they possess. Moreover, this Alfa Romeo is an historic car, for with it Shuttleworth gained many successes, including the 1935 Donington GP.. It must be the only road-equipped P3 in the country, although in 1935 such a car was driven to victory in the Mille Miglia by Pintacuda and Della Stufa, at 71.3 m.p.h. 'MPH 374', for that is how the Alfa is registered" - and is indeed still handily UK road-registered today in 2018 - "... should pass as a sports car at club speed events.

"It should be a very effective car, either for speed events or the sheer exhilaration of driving it on the road. Who, I wonder, will buy it". As, indeed, we wonder still...

The car's surviving logbook for the registration number 'MPH 374' records that on 28th August 1953, this *Tipo B*'s ownership passed to the great British enthusiast and renowned car connoisseur, Dennis de Ferranti. Ferranti subsequently had it offered for sale by Jack Bartlett in August 1959 in association with Erwin Goldschmidt in the USA, who advertised it in the August 1959 edition of *'Road & Track'* magazine.

Another great classic-car connoisseur, the leading American *'Alfista'* Henry Wessels of Paolo, outside Philadelphia, purchased the car, painted it black, and would retain it for many years. Later repainted red, the Alfa was subsequently converted back into single-seater Grand Prix configuration for the 1980s, and it was then used widely in historic racing by both Henry Wessels himself and British *'Alfista'*, Christopher Mann.



© Tony Baker/Classic & Sportscar





1
Caption

1
Caption



14

15

13 (main)

The current owner behind the wheel,
Goodwood Revival, 2017.
© Jim Houlgrave

14

Rounding the Loews Hairpin, Grand Prix
Historique de Monaco.
© Jim Houlgrave

15

Through the Swimming Pool Complex,
Grand Prix Historique de Monaco.
© Jim Houlgrave

After spending a period in the ownership of Jeffrey Pattinson, it passed into the current vendor's hands as long ago as 1988, and for the past quarter-century it has shared garage space with such other wonderful cars as a Ferrari Dino 246 Grand Prix, Williams-Cosworth FW06, 300S Maserati, and a McLaren F1 amongst others. During this long period it has been very widely campaigned at international and national historic level, always painstakingly race-prepared and tended by respected veteran specialist engineer, George Fowles.

Today the car is offered not only in its historic Grand Prix pure-bred single-seater *Tipo B* Monoposto form, but is accompanied by the alternative 1940s-built two-seater body, enabling conversion of the car into a road-useable – and friendly – *Biposto* for which the car's retained UK road registration of 'MPH 374' would enable legal touring and rallying. So very much of the essence of classic car enjoyment and general high-performance motoring, plus the competitive lure of top-end historic Grand Prix car racing, is embodied within '5007'/'50007'. George Fowles advises that conversion from Grand Prix single-seater to road-going *Biposto* (two-seat) configuration should be easily achievable within two or three working days. We can in fact think of few direct parallels amongst the many hundreds of great classic machines that Bonhams has handled over so many years. In addition to the two-seater body, the car comes with FIA HTP papers and a UK V5 registration document.

We recommend this ex-Scuderia Ferrari, ex-Richard Ormonde Shuttleworth Alfa Romeo *Tipo B* as worthy of the keenest consideration by the most discerning of connoisseur collectors, and also the most enthusiastic of great car user/drivers...

£4,500,000 - 5,000,000
€5,100,000 - 5,700,000

Please note: Special bidder registration procedures apply to this Lot. If you intend to bid on this Lot you need to register your interest with Bonhams no less than 48 hours in advance of the Sale. Please also refer to the Guide for Buyers Page at the front of the catalogue.

353

**1926 BENTLEY 3-LITRE
SPEED MODEL SPORTS TOURER**

Coachwork by Vanden Plas

Body no. 1292

Chassis no. DE1220

Engine no. DE1225 (see text)

- *Original Red Label Speed Model Bentley*
- *Superb condition after comprehensive restoration*
- *Well-documented car, with interesting well documented history back to day one*
- *Many period photographs included in the extensive history file.*
- *Rare, surviving original-bodied Vanden Plas car*
- *Dr. Clare Hay report on file*





The genre of the sporting Vintage Bentley dates from the earliest days of Walter Owen Bentley's founding of the firm that bore his name and the partnership of his chassis and coachwork which was provided by local coachbuilder Vanden Plas. Between them they created a style that remained with the company throughout its first era of production: that of a compact sports car with lightweight open four seater touring bodywork. It was in this same guise that virtually all of the famed Le Mans campaigns were undertaken. Even when the 4-cylinder cars were usurped by their 6-cylinder models, the most sporting examples were still built in this guise. The legend of the 'Bentley Boys', Tim Birkin and their Le Mans successes, created the spirit and character of the brand that perpetuates today, particularly since its reinvigoration from the early 2000s. It is for this reason that the iconic Bentley 3-Litre Speed Model with Vanden Plas coachwork is such an important part of the Bentley story.

The story begins with early success in the 1922 Isle of Man Tourist Trophy, where Bentleys finished second, fourth, and fifth and took the Team Prize, which led to the introduction of the 3-Litre TT Replica (later known as the Speed Model) on the existing 9' 9½" wheelbase, short standard chassis.

Identified by the Red Label on its radiator, the Speed Model differed by having twin SU 'sloper' carburetors, a higher compression ratio, different camshaft, and the close-ratio A-type gearbox, the latter being standard equipment prior to 1927 when the C-type gearbox was adopted. These engine changes increased maximum power from the standard 70 to 80bhp and raised the top speed to an impressive 90mph. Other enhancements included the larger (11-gallon) fuel tank and (usually) Andre Hartford shock absorbers.

The 3-Litre was by far the most popular model of Vintage Bentley production, with some 1613 chassis built, however of those only a third were the short chassis Speed models. By the very nature of their racing association the privateers that bought these cars in the Roaring Twenties were keen to push these cars to their limits. A cursory glance through a few of the period service records show many returns to the factory following accident damage, making the actual survival statistics for all 3-Litres less than half of the original production. When it comes to the Vanden Plas 3-Litres, the actual number of surviving examples of what is undeniably the iconic Vintage Bentley look is rather modest, and they rarely appear for sale.



Cannes, 25 March 1927



Oulton Park, 1960



Sammy Davis behind the wheel of 'DE1220' Oulton Park



Bonhams is proud to offer one of these much coveted original Vanden Plas bodied Sports Touring 'Speed' Models. This jewel-like 3-Litre Sports model has an illustrious and well-known history having remained in the UK for much of its life and being prized since the early days of the car hobby. The extensive file with the car, comprising three full leather-bound volumes, charts photos of the car from the 1920s onwards.

DE1220 left the works in September 1926, destined for its first owner Eric Loder, and was accordingly registered with him in London, with the now distinctive plate 'YR 509'. When new, it was finished in silver over maroon paintwork and in this form can be seen as one of a group of cars in a photo in the *Autocar* on the seafront in Cannes in the South of France. By the mid-1930s however it had been repainted green, a colour scheme it retains today. It survived the 1930s and war era without issue, such that by the early '50s it was already well known in the Bentley Drivers Club circles, by now owned by noted enthusiast Philip Mann.

In his hands the car is likely to have received its first restoration and in testament to that rebuild, when exhibited at the 1956 Bentley Drivers Club Concours in Kensington Gardens – then one of the premier events of its kind in the world – it was awarded First in Class honours! It was also raced at Silverstone, and other events during this period, and there are many contemporary pictures on file showing the car in action.

It is thought that during this part of its career it may have had damage to the engine, as the upper half of the crankcase, while re-numbered correctly with the original number, does date from an earlier engine, and must have been replaced. Around this time, the car was also driven by much loved racer Mike Hawthorn in a Cavalcade of British Cars at Le Mans, and it features pictorially in the Hawthorn book "Golden Boy". In the 1960s, another popular racer, and hero of the Bentley Le Mans story S.C.H. 'Sammy' Davis would drive the Bentley at Oulton Park.



At this point, the car migrated to the USA where it remained with two long term owners, again active in the BDC, until the mid-1980s. Its original registration number was returned to the car on the arrival back in Britain and it would continue a lower key, but well maintained and managed life back home. At some point in this journey, perhaps for fashion and to cover its aging lightweight alloy coachwork, the metal tub was covered with fabric. The present owner, a passionate enthusiast for the 'Best of British' cars, acquired the '3' in 2010. Recognising its rarity as one of few original-bodied examples that have survived their 90+ years he commissioned a full restoration of the car.

The car was rebuilt from the ground up. Its engine was checked over carefully and found to need little attention, having previously been rebuilt with a new Phoenix crankshaft and rods. The cosmetics and bodywork were by now somewhat tired and in need of a thorough and careful refurbishment. This work was carried out to the highest possible standards, the later fabric and old skins removed from the wood frame, and the wood repaired where necessary.

The entire car was repainted in Brewster Green using traditional and correct nitro-cellulose paint, echoing the works Napier Green racers. The leather upholstery was completely retrimmed and chosen to match the coachwork, while all brightwork was exquisitely re-plated in contrasting nickel, and the imposing high-quality Carl Zeiss headlights, which had been on the car from the 1950s, were retained.

The result is simply stunning, it has taken a car that is rare by definition and placed it in a condition which very few of these cars have been treated to. In 2018, the Bentley has been freshly serviced by R.C. Moss and, adding to its extensive file, the car has received a report by Dr. Clare Hay.

£380,000 - 420,000
€430,000 - 480,000

354

*The ex-Works, Derek Hurlock, John Gott, Ken Rudd, Paul Fletcher, Bob Staples,
Tulip Rally class winning, Goodwood race winning*

1954 AC ACE ROADSTER

Registration no. UPJ 75

Chassis no. AEO1

- *The first AC-built Ace,*
- *Tap-Root of the Ace/Cobra dynasty*
- *In-period international Works Rally Car*
- *Much raced in period including multiple Goodwood wins*
- *Offered for sale for the first time in 50 years*
- *Present ownership since 1969*



'AE01' as unveiled at the 1953 Motor Show © National Motor Museum



'AE01' in the paddock, Goodwood, 1954 © Ferret Fotographic



'Of them all, the Ace was the truest sports car: it could be used for daily commuting or for high-speed long-distance touring, but it could also be driven to a race meeting, campaigned with distinction, and driven home again - even if that race was the Le Mans 24 Hours.' - *AC Heritage*, Simon Taylor & Peter Burn.

An influential and widely imitated design, the AC Ace (and its Cobra derivative) could trace its origins back to a one-off sports-racer built by chassis engineer John Tojeiro for Cliff Davis in 1952. The success of Davis' Tojeiro sports-racer prompted AC Cars to acquire the rights to the design, which was put into production in 1954 as the Ace. The Davis car's pretty Ferrari 166-inspired barchetta bodywork was retained, as was Tojeiro's twin-tube ladder frame chassis and Cooper-influenced all-independent suspension, but the power unit was AC's own, 2.0-litre, long-stroke six.

Designed by AC co-founder John Weller, this overhead-camshaft engine had originated in 1919. Nevertheless, in tuned form the Ace enjoyed great success in production sports car racing. Only 223 cars were delivered with the 2.0-litre AC engine compared with 463 Bristol-engined cars and a further 37 Ford-powered examples. Also crucially it is only the AC engined version such as this car which is eligible for the Mille Miglia.

The historic car offered here, chassis number 'AE 01', is the first Ace built by AC Cars and is believed to be that displayed in chassis form at the Earls Court Motor Show in October 1953 beside the Tojeiro-built prototype. The first Ace was road tested by *Motor* magazine (1st December 1954 edition, copy on file) and also for a national newspaper by future Formula 1 World Champion, Mike Hawthorn, who described it as 'beefy'. He also amusingly referred to the acceleration as 'like a rent owing tenant'!

Bob Staples, Goodwood, March 1959 © LAT



'AE01' blasting up a pass in the hands of Hazel Dunham, Alpine Rally, 1954



Registered 'UPJ 75', 'AE 01' was soon cutting its teeth in competition, commencing on 29th May 1954 at Silverstone with AC's Managing Director, Derek Hurlock, at the wheel. Hazel Dunham then drove the car at Goodwood, and in the Alpine Rally in July, with Hurlock back behind the wheel for the London Rally in September. He next drove 'AE 01' in the 1955 RAC Rally (held in March). In April, John Gott took over for the Tulip Rally, finishing 1st in class and 11th overall, and defeating no fewer than ten arch-rival Triumph TR2s in the process. At the time John Gott (who went onto lead the BMC works rally team), used to write detailed reports in *Autosport*, in which there is reference to his run in the Tulip in AE 01. Copies are on file.

There were a few more competitive outings for 'AE 01' whilst retained by AC Cars in various hands including those of famed Ace driver and tuner Ken Rudd, before the car was sold to Paul Fletcher, whose first event, at Goodwood on 10th June 1958, resulted in a win. Fletcher enjoyed considerable success with 'AE 01', adding another win and a 2nd place at Goodwood, and a 3rd place finish at Mallory Park before the season's end.

The Ace was then sold to Bob Staples who would become one of the stars of the thriving national production 'marque' sportscar racing scene with it. Staples first race with his new acquisition was at the Boxing Day meeting at Brands Hatch on 26th December 1958. Staples had commenced racing in 1957 with a tuned Ford Consul, graduating to a brace of Triumph TR2s and then a Lotus Eleven before purchasing the Ace.

In a memoir on file, Bob recalls: 'The AC is used daily for work and has proved successful in racing with a second place and fastest lap in the large sports car class at Brands Hatch on Boxing Day behind a Bristol-engined Frazer Nash.

'In this event I was very pleased to share the front row of the grid with Colin Chapman, Mike Costin and Jim Clark in their Lotus Elites. This was followed by a class win by over 10 seconds at Brands Hatch on March 1st...' At the BARC's Goodwood meeting on 14th March he was excluded from the results following a spin while in 2nd place, but had the satisfaction of lapping faster than any AC had before at the Sussex circuit.

Also on file are copies of correspondence between Bob Staples and AC Cars relating to his racing activities with 'AE 01' and their assistance with them. This most comprehensive history file also contains copies of Staples' racing notes showing lap times, tyre pressures, weather conditions, results achieved during the 1958/59 seasons, etc; numerous copies of race reports describing the car's successes; and a copy of the 1960 Whit Monday Goodwood programme cover showing 'AE 01' leading the field in the March 1959 event. By this time, AC-engined Aces were considered un-competitive, but Staples' car was very successful and as fast as many of the Bristol-engined versions. In a letter on file he says: 'The car went like the proverbial bomb, and I could give most AC Bristols a run for their money'.



John Gott and 'AE01' start the gruelling but for them triumphant Tulip Rally, 1955



Motor Sport magazine featured Staples' Ace on the cover of its April 1959 edition (copy on file) and towards the end of that year he advertised it for sale in *Autosport's* December edition, describing it as fitted with 'every possible speed and suspension modification'. One of its subsequent owners advertised the Ace for sale in November 1968, the last time that it has been offered on the open market; it was purchased by the current vendor early in 1969 and has been a much-loved family member ever since. Fifty years ago, the then 14-year-old Ace was just another old sports car (the term 'collectors car' had yet to be invented) and despite its historical significance was used for all manner of everyday duties: transporting children, carrying shopping, travelling to work in summer, etc. In fact, the owner very nearly didn't buy the Ace because it was 'an early one', and when the seller mentioned it had been raced and rallied that was almost enough for him to walk away!

When purchased, the AC clearly needed some work, so the first rebuild took place around 1970/1971. Everything was stripped out, the paintwork taken back to bare alloy, and the car re-sprayed. A new wiring loom was installed and various new components purchased, while the engine was rebuilt with new pistons, liners, valves, etc. Most of the chromium brightwork was re-plated and new shock absorbers fitted, as was a new stainless steel exhaust system. The chromework, amazingly, is still almost as good as new, and the shock absorbers

and stainless exhaust are also still on the car. Apart from its periodic rebuilds, 'AE 01' has been used regularly and fairly continuously in the 49 years of the vendor's ownership. While other cars came and went, the Ace survived.

Between 1994 and 1999, a complete 'last nut and bolt' body-off restoration was undertaken, including a professional interior re-trim. The Ace was stripped to bare metal, the body was taken off the chassis, poor areas of aluminium were cut out and replaced, and the body was carefully replaced. The chassis was stripped, re-painted, and all necessary parts, bushes etc replaced. It was then re-sprayed in cellulose after many of the inner body panels had been replaced, while at the same time, the engine was rebuilt and all components either renewed or refurbished (details on file).

Subsequent works have included suspension bushing (2001); engine work with new pistons and liners (2003); leaf springs reset and re-tempered, radiator refurbished (2010); engine fully rebuilt by AC specialist Rod Briggs, carburettors and distributor fully refurbished (2013); new Michelin X tyres and new windscreen glass fitted (2015); new battery fitted, cylinder head tested and work done following No.1 cylinder leak (2017). In addition, in 2017 the correct wood-rim steering wheel was repaired and fitted having been off the car for at least 30 years.

'AE01' Ken Rudd Prescott Hill Climb, 1955 © Ferret Photographic



'AE01' on the 1955 RAC Rally driven by Derek Hurlock



As the first proper (AC-built) Ace, and with substantial international rallying and UK circuit racing history, all in the 1950s, it is inevitable that 'AE 01' should incorporate a number of departures from the original standard specification. The most obvious of these modifications is the addition of bonnet and side vents. The former can be seen in photographs from as early as 1955. The side vents were added sometime before June 1958 when the car commenced its major circuit-racing career (see Goodwood photograph of Paul Fletcher). The inner wheelarch panels are rounded, unlike the normal standard 'square cut' variety. Also, a quick-release panel within the main panel is fitted to allow better access to the front suspension. The rear of the car was modified to a shorter boot and rectangular rear light cluster, as per 'later' cars. It is not clear when or why the boot modification was carried out, but a rear-view photograph from *Autosport* in May 1959 shows the short boot with a single rear light unit, while in the 16th October 1959 edition the Ace is shown with the rectangular lights.

The chassis plate shows that engine number 'UMB 2058H' was installed originally. It is believed for racing purposes an updated engine, 'CL 2235' was fitted (equating to late 1955/early 1956) which in turn was modified to 'CLB' specification (see letter on file from AC Cars). When bought in 1969, the engine had a special camshaft with an exaggerated profile, which regularly broke valve springs so was replaced. There is evidence on file of similar problems experienced by Bob Staples when racing.

The suspension's transverse spring arrangement is quite different, in that the original mounting points in the centre of the main carriers have been removed, and new mountings further out on the carriers installed. This is often referred to as a 'Cooper Spring' arrangement. The overall effect is to give shorter spring travel, making the suspension stiffer. It is likely this was carried out for the circuit race programme (ie in the late 1950s).

The car was fitted with front disc brakes during its competition period. These, of course, became an option and then standard on the Ace from 1957. The wire wheels are 56-spoke type, as fitted from 1957 also. They too would have been part of the competition upgrades.

The full width curved screen is a one-off; it is not a Cobra or normal Ace curved windscreen. The screen is wider and shallower, and the side arms are fabricated specifically to give a much more angled mounting than the standard straight arms.

This was no doubt done to improve the aerodynamics for circuit racing. It is interesting to see that of the many racing photographs, some show this screen fitted while many others show a racing-type fly screen. This is accounted for by the differing regulations for the production sports car events entered.



Staples leading Robesom and Wilks, Brands Hatch, 1958

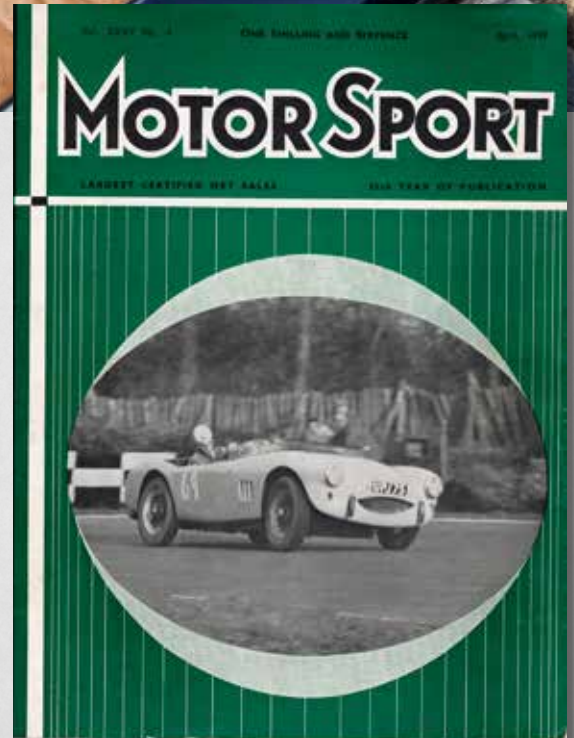

'AE01' as featured on the front cover of *Motor Sport*, April, 1959

Paul Fletcher and 'AE01' on there way to another win at Goodwood, 1958 © Ferret Fotografic



355

First owned by Piero Taruffi

1954 LANCIA APPIA SALOON

Registration no. not UK registered

Chassis no. 5894

- Series I model
- Right-hand drive
- FIAT twin-cam engine
- Single family ownership for over 30 years
- Extensively campaigned in historic events





Styled like its Aurelia B10 big brother, Lancia's new small car - the Appia - was premiered at the Turin Motor Show in 1953. The Lancia tradition of innovation in automotive technology was exemplified by the Appia's ultra-compact engine: a narrow-angle (10 degrees), 1,089cc V4 whose inclined overhead-valves were set in hemispherical combustion chambers and operated by twin, block-mounted camshafts. The unitary chassis construction adopted on the pre-war Aprilia was continued, as was Lancia's traditional sliding-pillar independent front suspension. Body styling was similar to that of the bigger Aurelia, and Series I cars featured aluminium doors, wings, and bumpers. In a tradition inaugurated by the pre-war Augusta, the front doors were hinged forwards, the rears aft, and there was no central pillar.

A Series I model, this Appia saloon is of right-hand drive configuration like the majority of Lancias manufactured up to the mid-1960s. Its first owner was Piero Taruffi, the Italian racing driver whose Formula 1 career included works drives for Alfa Romeo, Ferrari, Mercedes-Benz, Maserati, and Vanwall. A former motorcycle champion and holder of various speed records on both two and four wheels, Taruffi was also an accomplished sports car driver. In 1957 he won the last ever Mille Miglia while driving for Ferrari, and retired from racing immediately after this tragic event, which had claimed the life of Alfonso de Portago.

First registered as 'RA 20851' in Ravenna, the Appia appears to have changed hands by 1956 when it was entered in that year's Rally Lido di Venezia driven by Sergio Lipizer. The Lancia also competed in the Rally Sestriere in 1957. It is currently fitted with a FIAT twin-cam engine, though when this conversion was done is not known.

By 1978 the Appia was in the ownership the Scianna family of Padua, there being bills on file addressed to Dr Rosario Scianna (1978) and Dr Francesco Scianna (1994) together with an ACI registration document (issued December 2011) in the name of Emma Scianna. While in the Sciannas' possession the Appia has competed in the Targa Florio (1986), Vernasca Silver Flag (2006 and 2015), Grand Tour of Sicily 'Targa Florio' (2009), and Mille Miglia (2010). Copies of the car's original Italian libretto, various press cuttings, and the aforementioned bills may be found in the car's extensive history file (inspection recommended).

£70,000 - 80,000
€80,000 - 91,000

356

2008 Geneva Motor show concept

2007 ASTON MARTIN V12 VANTAGE RS COUPÉ PROTOTYPE

Registration no. KX57 AML

Chassis no. AMLVANTAGEV12RS01

- *The first V12 Vantage prototype*
- *Featured widely in the motoring press*
- *Left-hand drive*
- *Six-speed manual gearbox*
- *Purchased directly from Aston Martin by the vendor*
- *Fully road legal*





'The V12 Vantage RS concept is based on Aston Martin's critically acclaimed V8 Vantage coupé, but the company's design and engineering team have fully exploited the design flexibility of their unique VH architecture and the motor sport development of their 6.0 litre V12 engine to create a dramatic and production feasible concept car focussed on extreme performance and dynamics.' – Aston Martin.

Unlike most motor manufacturers, Aston Martin has consistently preserved its prototypes, wherever possible selling them on once they had served their purpose rather than sending them to the crusher, which not only explains the continuing existence of the various 'DP' (Development Project) cars of the David Brown era but also that of the historically significant V12 Vantage concept offered here.

The classic hot-rodding technique of shoehorning a big engine into a small car is a well-trodden route to increased performance, and so it was with the V12-engined Vantage RS, which combined Aston Martin's largest engine with its most compact model. Built in just four months by Aston Martin's Special Vehicle Operations department, prototype chassis number 'RS01' – the car offered here – was unveiled to an invited audience of more than 700 VIP guests by the company's CEO, Dr Ulrich Bez, at the official opening of the British manufacturer's new design studio at Gaydon, Warwickshire on 11th December 2007.

Dr Bez promised that a production version would be considered should there be sufficient demand; the result was a deluge of enquiries from enthusiasts eager to get their hands on what promised to be Aston Martin's fastest road car ever.

Based on the V8 Vantage Coupé, the V12 Vantage RS prototype is powered by Aston Martin's familiar 6.0-litre V12 as found in the V12 Vanquish, DB9, and DBS production models. In the Vantage RS though, this engine has dry-sump lubrication and is effectively the same as that of the DBRS9 GT racer, producing 580bhp, an increase of some 70 horsepower over standard. Getting the V12 to fit the V8 Vantage chassis involved grafting on the engine cradle from the DB9, while the resulting weight increase and more forward weight distribution (52/48 front/rear as opposed to the Vantage's 48/52) was accommodated by revised suspension settings.

Despite the presence of the heavier 12-cylinder engine, the Vantage RS contrived to be lighter than the standard Vantage V8, tipping the scales at only 1,600kg for a power-to-weight ratio of 370bhp per ton. This saving in weight was achieved in part by simply omitting many of the 'luxuries' associated with a fully finished production car, so the Vantage RS has no ABS, traction control, air conditioning, satellite navigation, or sound system. Nevertheless, the interior was a good deal less Spartan than that of many such concept cars, with many surfaces trimmed in light grey Alcantara, creating an almost luxury ambience.



The prototype's unique pale blue livery was the subject of a competition to come up with a suitable name, that chosen by the design team being 'Mako Blue'. Aston Martin's Design Director, Marek Reichman said: 'The name is taken from the Mako shark, which is the fastest and most agile shark known to man. We thought the name not only reflected the colour, but also that the nature of the shark was synonymous with the character of the car.'

'The Maori translation for 'Mako' is 'Blue Lightning' which obviously is descriptive of both colour and car – a very befitting name.'

Immediately after being displayed on the Aston Martin stand at the 2008 Geneva Motor Show, 'RS01' was whisked away to the Paul Ricard circuit in the South of France where assembled motoring journalists were eagerly awaiting their opportunity to experience the V12 Vantage effect. The event was Aston Martin's traditional pre-season 'Winter Test' gathering of its works and factory-supported race teams, thus affording the opportunity for the V12 Vantage to stretch its legs in the company of the DBR9 GT1 racer, V8 Vantage GT2 development car, and LMP1 sports prototype. *EVO* magazine's Richard Meaden reported that the V12 Vantage RS was attracting more admiring glances than any of the other cars present: 'Take a look at the timing screens in each and every pit garage and it's obvious why: despite being the only non-race car present it is consistently outrunning the V8 Vantage N24s, the GT3 DBRS9s and the AMR Vantage GT2. Most impressively, its 175mph peak is identical to that of the GT1 DBR9.'

Top Gear's Bill Thomas even found it possible to stay with Heinz Harold Frentzen's DBR9 GT1 racer: 'He's running the same engine, see, but is loaded with a shedload more downforce, which equates to more drag. So I was just as fast, if not faster, in my clean, drag-free, road-going RS. What a moment, on the back straight at Ricard, slipstreaming Frentzen's Le Mans car comfortably in a road car... watching the speedo needle clock up toward 200mph.'

Testing 'RS01' at Silverstone, *Autocar*'s Steve Copley, was just as impressed by the V12 Vantage RS's stopping power: 'The brakes are phenomenal. They simply eliminate speed like nothing I've ever experienced, squeezing the car into the road and making you hang forward on the straps.' As well as *EVO*, *Top Gear*, and *Autocar*, RS01' also featured in *Motor Sport*, *Car*, and *Vantage* magazines, and copies of all their articles are on file.

In June 2008, 'RS01' attended the Goodwood Festival of Speed and during 2009/2010 was on display at the British Motor Heritage Museum, Gaydon. Retained by Aston Martin, it was sold by them to the current vendor - a VIP client - in 2013. The odometer was zeroed at that time, since when 'RS01' has completed only some 7-8 track-days of running – approximately 750 miles.

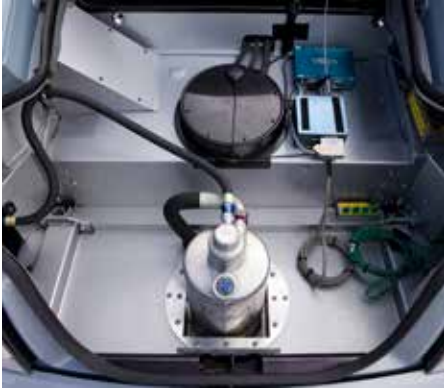

In October 2017, 'RS01' was back at the Aston Martin Special Projects (Q Advanced Operations) department at Wellesbourne where extensive re-commissioning and various other works were carried out in order to make the car road legal (via the IVA procedure). At the same time the 10-year-old fuel cell was replaced. Details of these works are on file in the form of a factory-prepared brochure outlining the V12 Vantage RS's history, and the car also comes with current MoT and a V5C registration document and a spare's package (see list on file). The vendor has also had some of the paintwork redone by Aston Martin.

In early 2008, Dr Bez confirmed that production of the V12 Vantage would commence in mid-2009, though with the 510bhp engine shared with Aston Martin's other 12-cylinder models rather than the prototype's 580bhp dry-sump racing unit. Given that the V12 Vantage RS concept resulted in a new and highly successful production model for Aston Martin, it can only be counted as an unqualified success. Offered for sale from the vendor's private collection of important Aston Martins, 'RS01' represents a unique opportunity for the discerning collector.

£400,000 - 500,000
€460,000 - 570,000



All photos © David Shepherd and Nick Dimbleby

357

The ex-Peter Thornton, Ian Dalglish actively and successfully campaigned

1960 ASTON MARTIN DB4 GT

Registration no. 170 PPL

Chassis no. 370/0110/GT

(original engine offered with motor car); and a race unit installed with no number.

- *Well respected and successful historic competition car*
- *Known history from new*
- *Offered with two engines (race unit installed / original offered with)*
- *Opportunity to continue racing, or convert back to road specification*







Here we are delighted to offer one of the most actively campaigned of all Aston Martin DB4GTs within recent times.

The Aston Martin DB4GT model was developed specifically to contest the FIA's then-newly introduced Grand Touring Car World Championship of 1960. The new competition replaced the former FIA Sports Car World Championship, which the British marque had dramatically won - in face of strong Ferrari and Porsche opposition - in 1959.

The short-wheelbase, lightweight DB4GT was launched at the 1959 London Motor Show within the Earl's Court exhibition halls. It was driven by Stirling Moss to win upon its debut at Silverstone and quickly began to accumulate further success, taking the battle to Ferrari.

Aston Martin's DB4GT model featured many modifications compared with the standard DB4 Coupé. No fewer than 5 inches were removed from the wheelbase and light-alloy door, bonnet, bootlid, firewall, floors, propeller-shaft tunnel and even suspension parts were adopted to trim weight. Perspex replaced toughened glass in the windows. The DB4GT featured the standard DB4 model's 4-speed synchromesh gearbox cluster but now housed within a lightweight aluminium case, while the disc brake system was updated with 12-inch front and 11-inch rear discs, clasped by Girling calipers.

The model's Tadek Marek-designed 3,670cc aluminium twin-overhead camshaft in-line 6-cylinder engine carried a redesigned new light-alloy cylinder head. The unit featured higher-compression pistons, twin spark ignition and breathed through a rack of three Weber 45DCOE twin-choke carburettors. Power output was quoted as an impressive 302bhp at 6,000rpm, while torque peaked at 240lbs/ft at 5,000rpm. Bodywork was thinly panelled on the Touring of Milan Superleggera principle, supported by a fine-gauge multi-tubular sub-structure. Overall weight was listed as 1,128kg - 2,480lbs.

When completed new in 1960 this particular Aston Martin DB4GT was UK road-registered 'KLL 007' and was sold to first owner G. Griffiths - possibly leading contemporary motor racing photographer Guy Griffiths, and founder/proprietor of the Cotswold Motor Museum. Mr Griffiths owned the car until 1963 when it was acquired by Mike Knight, the enthusiastic racing driver and creator of the Winfield Racing Drivers' School business, based in France. Between 1963 and 1966 Mike Knight ran '0110/R' in a number of sprint and circuit-race meetings, setting FTD at the MG Car Club's Firle hill-climb, another FTD in the BARC climb back at Firle and a second in the Brighton Speed Trials.



The car was twice damaged in accidents, being works repaired after each incident by the factory at Newport Pagnell. Mr Knight eventually sold the car to one R.M. Connell in Australia in 1970. The engine received a major factory overhaul before the sale was completed, and the car was then retained by Mr Connell until 1979, when it passed to fellow-Australian Andy Fraser - who in turn kept the car until 1990, while actively campaigning it in national competition.

It was returned to the UK in the ownership of V. Melkonian in 1990, before passing to G.K. Spiers in 1991, and then to leading Aston Martin Historic racing owner/driver Geoffrey Marsh of Marsh Plant Hire on the south coast. He would keep the car until 1995 when it was acquired by enthusiastic Historic racer Paul Whight. The car had been in road-going trim and tune when acquired, but Mr Whight then had it painstakingly prepared for essentially AMOC-organised competition. As driven by him the car proved very competitive in Class D of the AMOC Post-War race series at Brands Hatch and Silverstone, and finished well at Mallory Park, Oulton Park, Donington Park and Croft during the 1998 season.

Paul Whight continued to campaign the car successfully through 1999-2000 before in 2001 it was sold to Peter Thornton. Mr Thornton ran the car with its original engine for a couple of years before commissioning respected marque specialists Aston Engineering to build up a twin-plug 4.2-litre race engine. This was used in all races where size and originality was not an issue. Where it was, the original was re-installed to comply. This procedure continued until Mr Thornton sold the car. Peter Thornton campaigned the car with great success through 2001-2010.

The original engine '370/0110/GT' is offered with the car. During Thornton's ownership it was also looked after and refreshed by Aston Engineering as and when necessary. We understand it to be to 3.7-litre capacity and it was installed in the car when sold in 2010. Today, the race engine is installed and the original engine is offered with the car.



In 2011, Canadian enthusiast Ian Dalglish bought the car from Thornton, via Gregor Fiskens's dealership. In Mr Dalglish's ownership '0110/R' was returned to more of a road-going specification while its FIA papers were retained to enable occasionally circuit-racing use. The work was again carried out by Aston Engineering and from 2011-2015 the car was campaigned in numerous further Historic events. The car became a regular invitee to the annual Goodwood Revival Meeting, being co-driven there by owner Dalglish and regular team-mate Joe Twyman (2012), by Le Mans winning driver Romain Dumas, by Tiff Needell (2013) and Indianapolis '500' winner Danny Sullivan (2014). The owner also campaigned the car extensively in European Historic events, running at the front of Grid 3 at the 2014 Le Mans Classic and taking a class win in the 2014 Tour Auto, in France.

Within the extensive documentation file accompanying this most attractive road/racing Aston Martin DB4GT is one of the most impressively comprehensive racing record listings we have ever encountered. It covers the period from 1998, listing the exploits in this car of drivers Paul Whight, Peter Thornton, John Day, David Garrett, Gillian Goldsmith, Tom Alexander and Adrian Willmott.

The impressive list of venues upon which this Aston Martin DB4GT has performed includes Goodwood, Spa-Francorchamps in Belgium, La Sarthe at Le Mans and Dijon-Prenois, in France, plus Brands Hatch, Silverstone, Mallory Park, Oulton Park, Snetterton, Donington Park and Thruxton within the UK.

Perhaps most impressive of '0110/R's racing achievements have come in the Spa-Francorchamps Six-Hour Endurance classic in Belgium, in which Peter Thornton/David Garrett/Tom Alexander won their class and finished 8th overall from no fewer than 70 starters in 2003, followed by a 2nd in class there in 2005, and 7th overall amongst 83 starters in 2007. In the 2009 Le Mans Legends event the car finished 3rd in class, and then 1st in class/7th overall at the Spa Six-hours the same year. 2010 brought yet more success.

This well-presented, painstakingly cared-for Aston Martin DB4GT is extremely well-known within the Historic GT racing scene and now offers the new owner the opportunity to continue its historic racing career, or convert back to standard road specification with its original engine.

£2,300,000 - 2,500,000
€2,600,000 - 2,900,000



358

**1989 ASTON MARTIN V8 VANTAGE
'X-PACK' SPORTS SALOON**

Registration no. G499 TYT
Chassis no. 12691

- *Three owners*
- *Circa 49,500 miles from new*
- *Impeccably maintained*
- *Present ownership since 2007*
- *Comprehensive history file*





'People who buy the Vantage will do so in the first place for its performance, and they will not be disappointed. The figures speak for themselves. But they should take extra heart because it is one of the easiest true high performance cars to drive well: and it has been given brakes to match. In comfort too, it has much to offer, and there is a great deal of what is best in the British tradition of designing and building sports cars in its making.' - *Autocar*.

The performance figures *Autocar* referred to were a 0-60mph time of 5.4 seconds and an estimated top speed of 170mph, figures comparable with those achievable by a Ferrari Daytona or Lamborghini Miura.

With the introduction of the Vantage in 1977, Aston Martin's V8 was thrust back into the supercar league. The name had previously been applied to high-power versions of the DB six-cylinder cars, and in the V8's case the Vantage tune delivered around 375bhp; in Rolls-Royce fashion the factory chose not to disclose the actual figure, merely claiming that power was 'adequate'. Its superior performance aside, the Vantage was readily distinguishable from the standard product by virtue of its blocked-off bonnet scoop, blanked air intake, front chin spoiler and lip on the boot lid.

ZF five-speed manual transmission was standard equipment, though a handful of Vantages were built with the Torqueflite automatic gearbox. With either transmission performance was shattering, the Vantage's 0-100mph time of 12.7 seconds making it the world's fastest accelerating production car at that time. For those with a yen for even greater performance, there was the factory's optional 'X-Pack' of engine enhancements that raised peak power to a mighty 432bhp. By way of comparison, Ferrari's contemporary 12-cylinder Testarossa could only manage a relatively paltry 390 horsepower.

The rare V8 Vantage X-Pack offered here, chassis number '12691', is one of the very last built prior to the model's demise in 1989; in fact, only five right-hand drive manual transmission V8 Vantage saloons were built subsequently. The Aston was delivered new on 1st August 1989 to its first owner, Mr Michael Goold of W A Goold (Holdings) Ltd, who appointed official Aston Martin service dealer Chapman-Spooner Ltd of Aldridge, West Midlands to undertake its routine maintenance. Following Chapman-Spooner's closure in the mid-1990s, John Lane (formerly the Service Manager at Chapman-Spooner) was employed privately in conjunction with André Bloom Thoroughbreds to continue the maintenance of 'G499 TYT'.



In total, the Vantage was serviced on ten occasions up to September 1995 (at 41,808 miles) and details of all these are on file in the form of the stamped service booklet and numerous invoices, testifying to the owner's meticulous attention to detail. Every MoT certificate issued is available also.

After a brief period in storage with an Aston Martin distributor in the West Midlands, the Vantage was next serviced in July 1996 at 42,006 miles. The car remained in storage until August 1998, and in 1999 was despatched to Daypaul Auto Refinishers of Brownhills, West Midlands for full refurbishment. The latter included stripping the bodywork back to bare metal and then repainting it in the original colour of Salisbury Blue. Simultaneously, the underside was stripped back to bare metal, refinished and Waxoyl injected. The alloy wheels were refurbished and various items of brightwork re-plated. Subsequent to this comprehensive refurbishment, in late 1999, the Aston was transported back to the Goid Group's premises where John Lane de-commission the car and placed it on blocks for long term storage (recorded mileage 42,392).

Over the course of the next few years, the Vantage was annually removed from storage, serviced and exercised, the fuel tank being replaced during this period. In October 2003, the car was re-commissioned and offered for sale by André Bloom Thoroughbreds, the recorded mileage at this time being 42,413. Second owner, Mr P Sutherland of London

WC2, purchased the Aston in January 2004. André Bloom and marque specialist Rikki Cann maintained the car for Mr Sutherland, and another routine service was carried out in March 2004.

The current (third) owner purchased the Aston in 2007, since when it has formed part of an eclectic collection of classic cars ranging from an original early Mini Cooper S to a concours Aston Martin DB5. While in the vendor's care, the Vantage has been maintained regardless of cost by Rikki Cann. Works carried out over the last 11 years include a full brake and suspension overhaul in 2010 (£16,000), an engine overhaul and upgrade in 2011 (£30,000) and a routine service and other minor works in 2013 (£2,105). Undertaken at circa 46,000 miles, the aforementioned engine rebuild included new pistons and cylinder liners; converting the cylinder heads to accept unleaded fuel; overhauling the Weber carburettors; and detailing the engine bay, etc.

Offered with the owner's handbook/service book, tool kit, jack, and warning triangle, the detailed history file contains copies of every invoice, numerous expired MoTs, and the current V5C Registration Certificate. Well maintained throughout its life, this exciting Aston Martin Vantage X-Pack has covered only some 49,500 miles from new is freshly MoT'd and ready for sale.

£340,000 - 370,000
€390,000 - 420,000



359

One of the 50 originally built

**1931 BENTLEY 4½-LITRE
SUPERCHARGED TOURER**

Registration no. GW 2222

Chassis no. SM 3925 (see text)

Engine no. SM 3928

- Accepted as one of the 50 'Blower' Bentleys
- The ultimate Cricklewood Bentley
- Well-known in Bentley circles
- Offered from an important private collection





80th Anniversary Rally, Klausen Pass, 2010

The car offered here is a wonderful example of that most sought after of all W O Bentley models: the legendary 4½-Litre Supercharged, or 'Blower'. First shown at the 1929 London Motor Show, the 'Blower Bentley' was developed as a private venture by 'Bentley Boy' Sir Henry Birkin in order to extract more performance from the proven 4½-Litre model, which was becoming outclassed by its rivals on the racetracks of Europe. His aim was to produce a British car that would enable British drivers to continue to win races as spectacularly as the 4½-Litre that had won the 1928 Le Mans 24-Hour race.

The supercharger installation was engineered by the brilliant Amherst Villiers, who modestly claimed that it was 'recognised in engineering circles as a definite landmark in automobile construction'. Its potential was emphatically demonstrated when Tim Birkin took 2nd place in the French Grand Prix at Pau with his supercharged 4½-Litre tourer amid a field of monoposto GP racers.

The production cars were fitted with an Amherst Villiers Supercharger Mark IV, of Roots type with twin paddle rotors, which drew mixture from twin SU carburettors and was driven off the front of the crankshaft, the latter having been substantially strengthened to accommodate the increased power. With 9½lbs boost at 3,500rpm, the blown Bentley developed 175bhp, a healthy increase over the production 4½-Litre's 110 horsepower, while with 10lbs boost at 3,900rpm, 182bhp was produced. The first production model, chassis number 'SM 3903', a sporting four-seater bodied by Vanden Plas, was exhibited on Stand 130 at The Motor Exhibition at Olympia in October 1929 and would be retained as the Company demonstrator. Although similar in many respects to the standard 4½-Litre car, the new model was immediately distinguishable by the massive supercharger protruding at the base of the radiator.

Only 50 production supercharged 4½-Litre Bentleys were built to support the homologation of five Birkin team cars; among the few cars of their day capable of 100mph on the open road, they have always been regarded as the supercars of their era. *Motor Sport* spoke of the Blower's 'remarkable acceleration' and 'ancestry of well-tried racers' and called it 'a car for the connoisseur of sporting cars...'



Retaining its original registration, GW 2222, chassis number 'SM 3925' was the last of the first batch of 25 production supercharged 4½-Litre cars manufactured by Bentley Motors in 1930/1931. Completed in June '31, it is one of only five 'Blowers' originally delivered with saloon coachwork: three (including 'SM 3925') being bodied by Freestone & Webb and one each by Maythorn and Gurney Nutting. The first 25 chassis, 'SM 3925' included, were fitted with a plain supercharger centre casing, which was changed to a ribbed pattern for the second batch of 25 chassis ('MS3926-3950'). Most of the earlier cars were converted but 'SM 3925' is one of the few still fitted with a plain-case supercharger, albeit not its original unit; the supercharger fitted (number '121') is from the 1930 Olympia Show car, 'SM 3920'. The engine originally fitted to chassis 'SM 3925' was 'SM 3928', this sort of variation between engine and chassis numbers being typical of Bentley Motors' production practice.

This particular 'Blower' was ordered from Jack Barclay's London showroom by one Terence Byron of Whaley Bridge, Cheshire, as evidenced by a copy of the original order document on file. Chassis records (copies available) list the next owner as one L K Cornish of London N9 followed by G J Dawson of Lambeth, Southwest London.

In 1935, apparently still owned by Dawson, the Bentley was returned to the works for repair following an accident. As was Bentley Motors' practice, many of the parts used in the rebuild had been taken from other cars and reconditioned before being put back into service.

The factory record states 'chassis frame reconditioned', which usually indicates the fitment of a previously used replacement chassis frame from Bentley Service Department stock. Further parts also fitted at this time included a new front axle bed, new dumb irons, new top steering arm and front anchor plate, new offside stub axle, new steering wheel and worm wheel shaft. Two new Lucas headlights and a pair of new front road springs were also fitted and the radiator reconditioned. Later, in November 1938, the factory supplied a replacement D-Type gearbox: D-7015 for the car.

Component swaps are by no means uncommon among Cricklewood-era Bentleys, and this car's original engine later found its way into 3-Litre chassis number 'HT1633', while the reconditioned front axle and steering box taken from 'SM 3925' were fitted to 4½-Litre chassis 'HF 3196'. Fitted with a two-seater body and owned by Kemp Place, 'HF 3196' was raced by him throughout the late 1940s/1950s.





In 1984, the ambitious project to return 'SM 3925' to its former glory commenced, sourcing and ultimately utilising as many of the original components as possible, a Herculean task that would take many years to complete. During this period of ownership a genuine and original period heavy gauge chassis frame was fitted with engine 'SM 3928', sourced in 1989 and then a few years later, the sale of the ex Place racer, known as 'Black Bitch', brought with it the opportunity to acquire the original front axle and steering box. A suitable D-type gearbox was found - 'D-7026' - amazingly only 11 numbers away from the 1938 replacement.

The rear axle was sourced using the common practice of using an original and genuine Bentley 6½-litre unit - the differential unit was originally fitted to Speed Six chassis number 'NH 2728' - and the rear axle banjo is from a 6½-litre saloon - chassis number 'FW 2602' - which had been subject to a rear axle change at the factory in November 1934, suggesting this axle had been already been recycled, reprocessed and subsequently used in another car in the interim time.

Of all the components that make up a 'Blower' Bentley it is the supercharger, that presents the greatest difficulty for restorers; fortunately, the Olympia Show car's unit was located in the USA and purchased. It was decided to rebuild the car with the enduringly popular Vanden Plas Team Car-style tourer coachwork.

Since the rebuild's completion in 1993, 'SM 3925' has been enthusiastically enjoyed by only two owners, and in 2010 joined 17 other 'Blowers' in Switzerland to celebrate the 80th anniversary of the model's debut at Le Mans. 'SM 3925' performed faultlessly on this fabulous Alpine tour, of course driving down from England and taking the long way home to include a visit to the LM Classic, where it was immediately waved straight through and directed in to the paddock with the competing Vintage Bentleys that year. Accompanying documentation includes the 1990 FIVA card, 1994 FIA papers, 2012 FIVA Identity Card, and the aforementioned copy factory records, etc.

'Blower' Bentleys rarely come on the market and thus 'SM 3925' represents a possibly once-in-a-lifetime opportunity to acquire one of these charismatic cars, presented in excellent condition throughout, 'on the button', and ready to drive away. A welcome invitee to the world's most prestigious and exclusive historic motoring events, there can be no better way to enjoy the many celebrations planned for Bentley's 100th anniversary in 2019.

£2,000,000 - 2,500,000
€2,300,000 - 2,900,000



80th Anniversary Rally, 2010



360

**1985 FERRARI 308 GTS
QUATTROVALVOLE TARGA COUPÉ**

Registration no. B82 COG

Chassis no. 55059

- *Delivered new to the UK*
- *Right-hand drive*
- *Circa 150 miles since acquisition in 2013*
- *Full service history*
- *All books and tools*





Ferrari's line of highly successful V8-engined road cars began with the 308GT4 of 1973. Badged as a 'Dino', the all-new 308GT4 2+2 superseded the preceding Dino V6. The newcomer's wedge-shaped styling - by Bertone rather than the customary Pininfarina - was not universally well received but there were no complaints about the performance of the 3.0-litre quad-cam V8 engine, which was carried over to its successor.

Introduced at the Paris Salon in 1975, the stunningly beautiful 308GTB - Ferrari's second V8 road car - marked a return to Pininfarina styling following the Bertone-designed 308GT4. Badged as a 'proper' Ferrari rather than a Dino, the 308GTB had changed little mechanically apart from a reduction in both wheelbase and weight, retaining its predecessor's underpinnings and transversely mounted engine that now featured dry-sump lubrication. In road tune this superbly engineered power unit produced 255bhp, an output good enough to propel the 308GTB to a top speed of over 150mph. Produced initially with glassfibre bodywork - the first time this material had been used for a production Ferrari - the Scaglietti-built 308GTB used steel after April 1977. Further developments included the introduction of an open-top GTS version with Targa-style removable roof, the adoption of Bosch K-Jetronic fuel injection and, finally, revised cylinder heads with four valves per cylinder on the Quattrovalvole (Qv) model in 1982.

An exhilarating driver's car and a Ferrari purist's delight, the 308GTB and its many derivatives proved a huge commercial success for Maranello with over 12,000 sold.

Representing the 308 in its ultimate, Quattrovalvole form, this example of Ferrari's first Pininfarina-styled V8 road car was sold new in February 1985 to one P J Matthews of Birmingham before being exported to Spain in 2004. Re-imported and reunited with its original UK registration number in 2013, the Ferrari was purchased by the current (sixth) owner that same year from Mr Melvin Douglas Bonner, who had acquired it in 1999. The vendor advises us that he has partly restored the car, including replacing the CD player. 'B82 COG' has covered only some 150 miles while in his ownership, and is currently MoT'd until June 2019.

In the well organised history file there are various invoices for parts purchased and work carried out; some documents from the car's time in Spain; a list of past owners and servicing up to September 2013; and a V5C Registration Certificate. Described by the private vendor as 'driving beautifully', the car also comes with its original Ferrari book pack, handbook, warranty card, tool kits (x2), etc. The service card lists services in 1985, 1986, 1988, 1989, 1999, 2000, 2003, 2006, and 2008. A quantity of spare parts and a workshop/parts manual are included in the sale.

£75,000 - 90,000
€86,000 - 100,000

For details of the charges payable in addition to the final Hammer Price of each Lot please refer to paragraphs 7 & 8 of the Notice to Bidders at the back of the catalogue.

1951 JAGUAR XK120 3.8-LITRE ROADSTER

Registration no. TUR 25

Chassis no. 660587

- *One of only 1,175 right-hand drive roadsters*
- *Single family ownership from 1985 to 2016*
- *Rallied extensively*
- *XK150 disc brakes all round*



'We claimed 120 mph (for the XK 120), a speed unheard of for a production car in those days' - William Heynes, Chief Engineer, Jaguar Cars.

Conceived and constructed in but a few months, the XK120 debuted at the 1948 Earls Court Motor Show where the stunning-looking roadster caused a sensation, the resulting demand for what was then the world's fastest production car taking Jaguar by surprise. With orders rolling in apace, Jaguar had no choice but to think again about the XK120's method of construction. The work of Jaguar boss William Lyons himself and one of the most beautiful shapes ever to grace a motor car, the body had been conceived as a coachbuilt, aluminium panelled structure for the simple reason that Jaguar expected to sell no more than 200 XK120s in the first year! In conjunction with the Pressed Steel Fisher Company a new all-steel panelled body was developed, which retained the fabulous looks of the coachbuilt original while differing in minor external details. Beneath the skin the steel car was entirely different and it would take some 20 months of development before manufacture could begin.

The XK120's heart was, of course, the fabulous XK engine, which had been developed during the war and was intended for Jaguar's forthcoming Mark VII saloon. A 3.4-litre 'six' embodying the best of modern design, it boasted twin overhead camshafts running in an aluminium-alloy cylinder head, seven main bearings and a maximum output of 160bhp.

It went into a chassis that was essentially a shortened version of the simultaneously announced Mark V saloon's, featuring William Heynes' torsion bar independent front suspension. Jaguar lost no time in demonstrating that the XK120's claimed top speed was no idle boast. In May 1949, on the Jabbeke to Aeltre autoroute, an example with its hood and side screens in place recorded a speed of 126mph and 132mph with the hood and windscreen detached and an under-tray fitted.

The XK120 set new standards of comfort, roadholding and performance for British sports cars and, in keeping with the Jaguar tradition, there was nothing to touch it at the price. Coupé and drophead coupé versions followed, and for customers who found the standard car too slow, there was the Special Equipment (SE) package which boosted power to 180bhp. With either engine and regardless of the type of bodywork, the XK120 was a genuine 120mph car capable of sustained high-speed cruising.

The XK120 was produced until 1954 and would prove to be the most popular of the XK series, with 12,078 examples built, of which only 1,175 were right-hand drive roadsters like that offered here. Finished in cream livery, '660587' was completed on 11th January 1951 and supplied new to Henlys in London on the 29th of that month, subsequently belonging to the same family from 1985 to 2016.



In 1985, this XK was prepared for rallying and tours, including the Pirelli Marathon, while three years later, in 1988, it benefited from extensive works carried out by Roman Garage near Grantham. These works were supervised by the late W E 'Wilkie' Wilkinson, celebrated former team mechanic with Écurie Écosse and BRM (see invoice on file). The original engine being deemed beyond repair, an overhauled and tuned (9.0:1 compression ratio) 3.8-litre unit was installed, while at the same time the braking system was up-rated with XK150 discs all round. Since then, the car has been rallied regularly, including the 2001 Rally of the Tests, featuring as the main illustration in *Classic & Sports Car* magazine's article on the event.

Roman Garage continued to service the XK on a regular basis, as evidenced by bills on file. The file also contains an old-style green logbook, V5C registration document, Heritage Trust Certificate, and numerous MoT certificates, the earliest dating back to 1972. Since its acquisition by the current vendor in November 2016, the XK has been maintained by his own in-house mechanic. A wonderful opportunity to acquire an upgraded example of Jaguar's iconic and much loved XK sports car in its earliest and purest form, eminently usable and ready to enjoy.

£75,000 - 85,000
€86,000 - 97,000



1964 MERCEDES-BENZ 300SE 'FINTAIL' COMPETITION SALOON

Registration no. HTW 519B
Chassis no. 11201422005805

- A Goodwood Revival regular since 1998
- Built by Tipton Garage
- Maintained by INRacing



This Mercedes-Benz historic competition saloon is one of two in this sale (the other being Lot 380) race-prepared by motor engineer Richard Miles of Tipton Garage, a former Brabham Formula 1 mechanic and Daniel Richmond's right-hand man at legendary tuners, Downton Engineering. The project was commissioned by the then owner, a prominent Mercedes-Benz collector and marque expert. After a lengthy search for a suitable donor, this right-hand drive 300SE 'Fintail' was stripped down to the bare shell and rebuilt from the ground upwards to racing specification, including a FIA-compliant full roll cage and all mandatory safety equipment. Both the engine and the four-speed manual gearbox were painstakingly rebuilt at Tipton Garage by Richard's son, Stephen Miles, a former development engineer at Janspeed Engineering where he was a key member of the team responsible for running Nissan's works effort in the British Touring Car Championship.

A limited-slip differential was installed, while the original power-assisted steering was retained to reduce driver fatigue – these big Mercedes-Benz saloons are heavy! Goodwood's particular insistence on the retention of period features on historic saloons meant that the Mercedes had to keep its factory steel wheels and full interior trim. Like that of its 'Ponton' stablemate, this car's attention to detail has seen it acknowledged as one of the best presented entries at the Goodwood Revival, even impressing visiting directors of Mercedes-Benz.

Completed in 1998, this historic racer has been invited to all applicable St Mary's Trophy races since the Goodwood Revival was instigated 20 years ago. In those early Revivals, the then owner co-drove with *Octane* magazine's renowned journalist/racer, Mark Hales, and later with a succession of celebrities including racing legends such as Sir Jack Brabham, Richard Attwood, Brian Redman, Jochen Mass, and Derek Daly, as well as motoring enthusiast and actor, Rowan Atkinson. 'HTW 519B' has also competed at the Nürburgring's 'Nordschleife' Marathon three times; at the Silverstone Classic on numerous occasions; and at many HRDC events. During this 17-year period, the car was always maintained regardless of cost by Tipton Garage, who kept it in first class order.

When the owner/driver retired from active participation in motor sports, both of his historic Mercedes-Benz racers were purchased by the current vendor. The current owner acquired the car in January 2016 and is only offering it for sale today for medical reasons. This Mercedes (and its 220S stablemate) has been maintained to a very high standard by Ian Nuthall's 'INRacing', specialists in historic competition cars of all kinds, and is presented in ready-to-race condition. Offered with old-style FIA papers, this well-known Mercedes-Benz racing saloon represents a wonderful opportunity to own a car having one of the longest associations with Goodwood's much loved Revival meeting.

£38,000 - 44,000
€43,000 - 50,000

363

1959 MORGAN PLUS 4 2.1-LITRE COMPETITION ROADSTER

Registration no. 403 UYS

Chassis no. 4302

- *Landmark Morgan model*
- *Lawrence Tune conversion*
- *Offered from a private collection*
- *FIA papers*
- *Ready to enjoy*



Morgan's first four-seater, four-wheeled sports car - the Standard 10-engined 4/4 - appeared in 1937, forming the mainstay of production up to 1950 when it was superseded by the larger and more powerful Standard Vanguard-engined Plus 4. With 70% more power than the 4/4 courtesy of the 2,088cc Vanguard engine, the Plus 4 represented a major step forward in the evolution of the Morgan sports car. Although the traditional chassis layout was retained - what else would one expect from Morgan? - it did undergo extensive alteration, gaining in both wheelbase and track dimensions while being considerably strengthened. The centrally mounted Moss gearbox was carried over from the 4/4.

With supplies of the old flat-fronted radiator and free-standing headlamps coming to an end, Morgan opted for a front-end makeover for 1953, filling in the gap between wings and body with a sloping valance that incorporated the headlamps in a pair of cylindrical fairings. The radiator grille was cowlled and gained a quarter-moon trim panel at the top, which carried the Morgan badge. A change in vehicle regulations soon forced Morgan to raise the headlights, but the result remained dissatisfying and led to a further revision that saw the 'interim' radiator grille replaced by a curved design and the headlamps placed in teardrop-shaped housings atop the valance. At last the quintessential Morgan look had arrived.

Their robust and tuneable Triumph engines made the lightweight Morgans the cars to beat in production sports car racing. A legendary name in Morgan circles, Chris Lawrence (Lawrence Tune) was one of the foremost exponents, winning 19 out of 22 races in 1959 at the wheel of his home-tuned Plus 4 to take the National Championship for Production Sports Cars. Lawrence Tune was formed in October 1959, and a couple of years later supplied Morgan with a batch of specially tuned TR engines for the limited edition 'Super Sports' model of 1961.

Morgan factory records show that chassis number '4302' was delivered new on 16th September 1959 via Worldwide Motors Inc of Los Angeles, California, and came equipped with wire wheels and a Moss gearbox. The car was originally finished in black with red interior. Its early history is not known, but it has been fitted with a performance conversion from marque specialists, Lawrence Tune.

By 1988, the Morgan was in the care of Philippe Bernard in Belgium, who would keep it until 2005. While in his ownership, some £24,000 was spent on servicing and upgrades with Melvyn Rutter, Brands Hatch Morgans, Racetorations, Legion, and Harpers. In 2014, '403 UYS' was bought by John Harper, passing into the current vendor's ownership the following year. An older restoration, the car is fitted with a 120bhp engine (rolling road dynamometer sheet available), a close-ratio gearbox, and a roll-cage. Offered from a private collection, it comes complete with a hardtop (in white) and a spare set of 74-spoke competition wheels, and is ready to resume its competition career in the hands of a new owner.

£55,000 - 65,000

€63,000 - 74,000

THE ANDERSON COLLECTION



THE LATE ROBERT ANDERSON

Robert was a chartered surveyor by profession, based in Melbourne, Derbyshire. From an early age he clearly had a keen interest in engineering inherited from his father, an engineer of some merit.

In 1961, aged just 17, he managed to acquire the 1929 Alfa Romeo 6c 1500 Sport and is pictured here, in that year, with the engine.

Robert continued his passion in 1983 buying this 1973 Ferrari Dino 246GT and in 1984 undertook a complete engine rebuild and full restoration.

On his fathers passing Robert inherited this very original XK140 which has been in Anderson family ownership since 1965.

Robert actively enjoyed all three cars regularly travelling to vintage events across the UK in them until he passed away in 2010. The cars have remained in Anderson family ownership, with Robert's three children, Helen, William and Charlotte, since then.



364

1956 JAGUAR XK140 COUPÉ

Registration no. WAU 532

Chassis no. 804598

- One of 843 right-hand drive XK140 Coupés
- Acquired by the second owner (vendor's grandfather) in 1965
- Present family ownership for 53 years
- Never restored
- Continuously maintained and highly original
- Ready to use 'as is' or restore



'For 1955, Jaguar present a range of models incorporating not only added refinements, but mechanical advances directly derived from their many outstanding successes in international competitive events. All the wealth of experience gained on the race-tracks of the world and in record-breaking speed and endurance tests is built into every Jaguar to provide for discriminating motorists the highest degree of efficient performance allied to comfort and safety.' - *Jaguar Cars Ltd.*

Newly introduced for 1955, the Jaguar XK140 was broadly similar to, though more refined than, its sensational XK120 predecessor, major engineering changes being confined to the repositioning of the engine 3" further forward and the adoption of rack-and-pinion steering. The suspension and brakes remained much as before, though with stiffer torsion bars at the front and telescopic shock absorbers replacing lever type at the rear. Outwardly the newcomer was distinguishable by its revised radiator grille, rear lights incorporating flashing indicators, and larger bumpers. The power unit remained Jaguar's well-tryed, 3.4-litre, twin-cam six, which now produced 190bhp in standard trim.

A close-ratio gearbox enabled better use to be made of the increased performance and overdrive became an option for the first time. Special Equipment (SE) cars came with wire wheels and Lucas fog lamps, and could be ordered with an engine developing 210bhp courtesy of the C-type cylinder head. XK140 performance was well up to the standards set by its exemplary predecessor, contemporary road-tests regularly recording top speed figures in excess of 120mph.

One of only 843 right-hand drive XK140 fixed-head coupés made, this example was supplied on 17th January 1956 to Reginald George Baird of Nottingham. Second owner James Henry Anderson (the vendor's grandfather) acquired the Jaguar on 3rd September 1965 and it has remained in the same family's possession ever since.

Hand written notes on file record the mileage covered increasing from 55,360 in 1972 to 65,162 in 1998, and the car also comes with sundry bills, a quantity of expired MoTs and tax discs, a V5 registration document, and MoT to June 2019. Refurbishment highlights include fitting a stainless steel exhaust in 1988; repainting the car in 1995; replacing the roof lining circa 2000; and installing a Kenlowe electric fan that same year.

Remarkably, despite being over 60 years old, 'WAU 532' has never been restored; rather, this wonderful XK140 has been maintained and serviced throughout its life and is a really honest car, ready to use 'as is' or restore.

£50,000 - 70,000
€58,000 - 80,000

365

1973 FERRARI DINO 246 GT COUPÉ

Coachwork by Pininfarina/Scaglietti

Registration no. LHB 188L

Chassis no. 06248

- *Iconic V6-engined Dino*
- *One of the final ('E') series*
- *Matching numbers*
- *Present family ownership since 1983*
- *Well-maintained*



'It is a thrill to drive a car like the Dino, one whose capabilities are far beyond what even an expert driver can use in most real-world motoring, and that is the Dino's reason for being. The real joy of a good mid-engined car is in its handling and braking and the Dino shone as we expected it to. The steering is quick without being super quick, and it transmits by what seems a carefully planned amount of feedback exactly what is going on at the tyres. Thanks to the layout's low polar moment of inertia the car responds instantly to it. The Dino's cornering limits are very high... ' – *Road & Track*.

It was the need for a production-based engine for the new Formula 2 that had prompted the introduction of a 'junior' Ferrari, the Dino 206 GT, at the Turin Motor Show in 1967. The latest in a line of Dino V6 'quad-cam' engines stretching back to the late 1950s, the new unit proved as successful on the racetrack as in the showroom, Derek Bell and Ernesto Brambilla both winning races in the European Championship, while Andrea de Adamich triumphed in the 1968 Argentine Temporada series.

Building on experience gained with its successful limited edition Dino 206S sports-racer of 1966, Ferrari retained the racer's mid-engined layout for the road car but installed the power unit transversely rather than longitudinally. A compact, aluminium-bodied coupé of striking appearance, the Pininfarina-styled Dino - named after Enzo Ferrari's late son Alfredo Ferrari and intended as the first of a separate but related marque - was powered by a 2.0-litre, four-cam V6 driving via an in-unit five-speed transaxle. The motor's 180 brake horsepower was good enough to propel the lightweight, aerodynamically-efficient Dino to 142mph, and while there were few complaints about the car's performance, the high cost enforced by its aluminium construction hindered sales.

A 2.4-litre version on a longer wheelbase - the 246 GT - replaced the original Dino 206 in late 1969. Built by Scaglietti, the body was now steel and the cylinder block cast-iron rather than aluminium, but the bigger engine's increased power - 195bhp at 7,600rpm - adequately compensated for the weight gain. A Targa-top version, the 246 GTS, followed in 1972.



The Dino 246 was built in three series: 'L', 'M' and 'E', these designations reflecting detail changes in the specification. Of the three, the M-series is by far the rarest, being produced during the early months of 1971 only. Changes from the preceding L-series included a 30mm increase in rear track; five-bolt fixing for the road wheels; internal boot release; seat-mounted headrests; and various minor improvements to the engine and gearbox. The final 'E' series incorporated all the changes made to its predecessors together with further improvements to the engine and gearbox and numerous other more minor details.

While not quite as fast in a straight line as its larger V12-engined stablemates, the nimble Dino was capable of showing almost anything a clean pair of heels over twisty going. Truly a driver's car par excellence and still highly regarded today.

One of the final E-series cars, the Dino 246 GT offered here is an original right-hand drive matching-numbers example built for the UK market and supplied by Dovey Motor Company, Cardiff. It was first registered on 2nd July 1973, the original owner being one Nicole Morgan of Glamorgan. In July 1974, the Dino was purchased by Harold Green & Sons, Cardiff, and on 2nd April 1978 passed into the ownership of one David Miller, also of Cardiff.

On 15th November 1983, the Ferrari was sold to the vendor's father. The latter had spent the day at Donington Park and was driving his XK140 (Lot 364) to the pub for a pint when he spotted the Dino, stopped to chat with the owner, and ended up agreeing to purchase it over a pint of Pedigree. The car has remained in the same family ownership ever since.

Originally white, the Dino was repainted red in 1984 by Bridgegate BMW body shop, while the original seats have been re-trimmed in black leather; all other trim is original. Hand written notes on file record the mileage as 25,356 in 1979 and 43,320 in 2009 (the current odometer reading is 45,610). The file also contains records of works carried out, journeys undertaken, etc; numerous bills for works carried out by specialists including Graypaul and Pegasus Motors; and expired MoTs dating back to 1978.

A very well cared for example, the Dino has been serviced in recent years by a retired former Graypaul mechanic. Running and driving well, the car presents well, albeit with some room for cosmetic improvement, and is MoT'd and ready to use 'as is'. A repair and workshop manual is included in the sale.

£190,000 - 240,000
£220,000 - 250,000

366

1929 ALFA ROMEO 6C 1500 SPORT TOURER

Coachwork by Phippen

Registration no. UL 1489

Chassis no. 0211459

- *Delivered new to the UK*
- *Brooklands competition history*
- *Converted into tourer configuration in the early 1940s*
- *Known ownership history*
- *Present family ownership since 1961*
- *Restored in the 1970s/1980s*
- *Rare twin cam Sport model*





APF Dempster at speed during the 1929 JCC High Speed Trial, Brooklands. (image part of lot)



'The 1750, and for that matter the 1500... must be among the finest ever made both from the point of view of engineering and driver satisfaction.' - Michael Frostick, *'Alfa-Romeo-Milano'*.

It was Enzo Ferrari, no less, who persuaded Vittorio Jano to leave FIAT's racing department and join him at Alfa Romeo. One of the most gifted and influential automobile engineers of all time, Jano would not only supervise Alfa Romeo's Grand Prix racing programme but also design its road cars. This happy state of affairs resulted in the latter emerging as some of the most exciting of their day, establishing the Milanese marque's reputation for producing sporting driver's cars second to none.

Jano arrived at Alfa in 1923 and by the following year had produced one of the most fabulous racing automobiles of all time - the legendary P2. As well as bringing Alfa much valuable publicity by virtue of its outstanding Grand Prix successes, the P2 provided the basis for Jano's first production model. Announced in 1925 but not produced for another two years, the 6C 1500 was designed as a fast touring car combining light weight with sparkling performance. The latter was achieved courtesy of a 1,487cc inline six-cylinder engine based on the P2's straight eight and producing 44bhp in single-overhead-camshaft Normale form. Twin-overhead-camshaft Sport and supercharged Super Sport models followed, the latter being the first of its type to feature the classic open two-seater coachwork by Zagato forever associated with sporting Vintage Alfas.

The Alfa Romeo 6C 1500 Sport was officially launched in 1928 specifically for competition use. Boasting an increased compression ratio and twin-barrel carburettor among other modifications, its twin-cam engine produced 54bhp, 10 horsepower more than the single-cam unit, while the Sport's fuel tank was relocated to improve weight distribution. The model made its racing debut in 1927 when Enzo Ferrari - at the time works driver for Alfa Romeo - won the 360km Circuit of Modena at an average of 107.6km/h in what was believed to be a prototype twin cam Sport. The 1500's sporting career, aided by its mechanical longevity, extended far beyond its production, which ceased in 1929 on the arrival of the 6C 1750. Of the 171 chassis built, only 20 1500 Sport models are known to survive today, one of which won the 2005 Mille Miglia Storica in the hands of Viaro/De Marco.

This particular Alfa Romeo 6C 1500 Sport was delivered new to the UK in 1929 and was raced at the Brooklands JCC High Speed Trials on 6th July that year by A P F Dempster, owner of Kingston Hill Garage (see photograph on file showing the original two-seater body). There is a further photograph on file showing the 6C sporting two-door fabric coachwork, believed to date from the late 1930s.

In 1943, 'UL 1489' was the subject of an article in *Autocar* magazine (April 9th edition, copy on file) while it was owned by Mr A J Phippen of Westbury-on-Trym, Bristol, who had purchased the car in 1939.



By this time the Alfa's original two-seater and subsequent Newns-built two-door fabric saloon bodies had been converted into an open tourer by Phippen, who rebuilt the chassis at the same time, a process that included moving the centre cross member back 8" to increase the leg room. He also lowered the floor beneath the front seats; dispensed with the Autovac, fitting an electric fuel pump instead; and replaced the Marelli dynamo, starter, switchboard and distributor with Bosch equivalents. Phippen also fitted Zeiss headlamps and Lucas spotlights, replacing the originals. A fuel gauge and ammeter were added to the dashboard instrumentation, and twin SU carburettors fitted in place of the original Zenith carburettor, the result being 'greatly improved starting, acceleration and petrol consumption'.

Phippen observed: 'Top gear could with advantage be higher, for 4,500rpm can quite easily be reached on this gear, corresponding to a road speed of 80mph, but the car's roadholding, steering and acceleration combine to provide the high average it is able to maintain for long periods'. Like many of its contemporaries, the Alfa was laid up for the duration of the war, though Mr Phippen concluded by saying that he looked 'forward to the time we can take to the road once more'.

Issued in 1953, the accompanying old-style logbook shows that the car was owned then by a Mr Kathro, and in 1957 by Marcus Niven, who at the time was racing against the likes of Graham Hill and Jim Clark. There is an invoice on file issued by Thomson & Taylor (Brooklands) Ltd to Mr Niven for an engine rebuild carried out in January 1957.

In November 1961, the Alfa was purchased by the vendor's late father and has been in the same family ownership ever since. The vendor's father carried out an extensive restoration and engine rebuild during the 1970s/1980s, and enjoyed driving the car to various Vintage events throughout his life. After the father's death in 2010, the car passed to his children, who agreed to put it on display at the Donington Grand Prix Museum where it was exhibited until 2016. A recent inspection by the registrar of the Alfa Romeo Pre-War Owners Club, Carol Corliss, who has known the car since the early 1960s, has confirmed its originality. Benefiting from a recent clutch rebuild undertaken by IN Racing of Nottingham, 'UL 1489' remains in excellent working order, driving beautifully.

In addition to the documents mentioned above, the history file contains 'as purchased' photographs; photographs of the 1970s/1980s restoration; hand written notes concerning the rebuild (perusal highly recommended); a quantity of expired MoTs dating back to 1999; and hand written notes detailing journeys made and miles covered. An original Alfa Romeo 6C Maintenance and Care handbook is included in the sale.

This is a very rare opportunity to acquire a matching-numbers 6C 1500, a model that not only inaugurated an unprecedented period of racing success for Alfa Romeo but also played a significant role at the very start of the Ferrari legend.

£180,000 - 240,000
€210,000 - 250,000



366 A

C. 1930 ALFA ROMEO 6C 1750 ENGINE

Numbered 0212781. Professionally rebuilt in 2000. Offered with a pair of bronze bodied SU carburetors, a quantity of head gaskets, inlet and exhaust manifold. Sold strictly as viewed.

£30,000 - 40,000

€34,000 - 46,000



366 B

C. 1930 ALFA ROMEO 6C 1750 GEARBOX

Gearbox, 0142765. With ratio 16x20. Virtually complete unit in original condition with finned cooling sump. Offered with a flywheel, gear lever, handbrake lever, crown wheel and pinion plus other parts. Sold strictly as viewed.

£15,000 - 20,000

€17,000 - 23,000

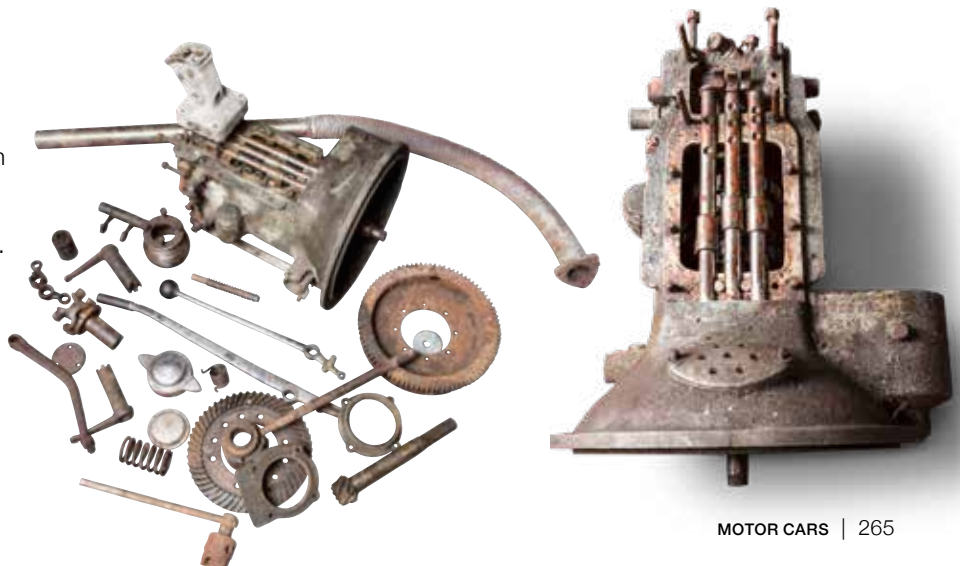

END OF COLLECTION

367

1936 MARENDAZ SPECIAL 13/70HP SPORTS TOURER

Registration no. FOF 395

Chassis no. 807

- *Ultra-rare 'Post-Vintage Thoroughbred'*
- *One of only some 80-120 made*
- *Continental-based 2.4-litre six-cylinder engine*
- *An older restoration*
- *Present ownership since 2004*



'Fast and well handling, the cars did well in rallies... (and) are still extremely elegant.' – Sedgwick & Gillies, *'A-Z of Cars of the 1930s'*.

An English manufacturer, despite the foreign-sounding name, Marendaz was founded in 1926 by Captain Donald Marcus Kelway Marendaz, an engineer who had completed his apprenticeship at Siddeley-Deasy before WWI. He had joined the Royal Flying Corps in 1916, serving as a pilot before being invalided out in 1918, and after the war became a partner in Coventry-based Marseel (later Marseal) Motors, manufacturers of a conventional Coventry-Simplex-powered light car. Following Marseal's closure, Marendaz set up DMK Marendaz Ltd in Brixton, South London, occupying the same premises as the London Cab Company and Bugatti's London agent. Attractive styled and with a distinctly Bentley-esque radiator, his early sports cars were called 'Marendaz Specials' and used 1½-litre four-cylinder Anzani engines, some of which were lined down to 1,097cc to compete in the up-to-1100cc racing category.

Marendaz's first-floor Brixton premises were cramped and impractical, so in 1932 he relocated to Maidenhead in Berkshire, reconstituting his company as Marendaz Special Cars Ltd. His new 'home' was the Cornwallis Works, also known as the 'Jam Factory', where the remarkable Burney Streamline and GWK cars had been made.

Modified Continental engines were used at first before Marendaz moved on to power units of his own design. His final model was the six-cylinder Coventry-Climax-powered 15/90. Most cars carried open two- or four-seat bodies, though there was at least one closed coupé built. Captain Marendaz supported a racing programme, entering some events himself, while one of the better-known Marendaz drivers was Aileen Moss, mother of Sir Stirling Moss. By the time Marendaz Special Cars was wound up in July 1936, an estimated 60 cars had been made at Maidenhead in addition to some 20-25 at Brixton, though one source states that as many as 120 might have been completed. Any unsold stock was sold off to Colliers of Birmingham, and Captain Marendaz moved on to building light aircraft.

A (copy) photograph on file shows this particular Marendaz, identified by its unique glass quarter-lights, at the Collier works, presumably in 1938. The registration 'FOF 395' was issued in Birmingham in June 1939. The earliest surviving registration record is an old-style buff logbook, issued in 1962, which lists Edgar Cogger of Harrogate, North Yorkshire as the owner at that time. Later on in the 1960s, 'FOF 395' was kept at the Claro Auto Works, a sports car garage in Harrogate run by a Mr Sterling. When Mr Sterling died, his stock of cars was dispersed by his family. 'FOF 395' was inherited by Mr Michael (Mike) Sterling and registered by him in the 1970s (date stamp unclear). The Marendaz, together with two 1930s MGs, languished in local lockup garages until 1982 when Mike Sterling advertised it for sale in *Exchange & Mart*.



The car was then sold by Mike Sterling to the immediately preceding owner, and following a complete restoration was back on the road in 1991, though seeing relatively little use thereafter. The current vendor purchased 'FOF 395' in August 2004.

The car's lack of use meant that various issues required attention, including freeing-off the seized brakes, overhauling the suspension, and having new half-shafts manufactured. Fortunately the six-cylinder Continental-based engine had already been fitted with marque specialist John Shaw's improved cylinder head, which ensures adequate cooling. The Continental 8F engines were sleeved down by Marendaz to 1,869cc, presumably for taxation purposes, but this unit (non-original but of correct type) retains its factory capacity of 2,394cc.

While in the present ownership, the Marendaz has been looked after by Riley specialist Keith Ponting, who has helped keep it in sound condition. Well known in VSCC circles, the car has competed – gently – at Curborough, Colerne, Madresfield, and Prescott. Representing a wonderful opportunity to acquire one of these rarest of 'Post-Vintage Thoroughbreds', the car is offered with a V5C registration document, the aforementioned logbook, and a history file containing restoration invoices, press cuttings, correspondence, etc. The Marendaz marque is supported by an active register, run by Graham Skillen.

£70,000 - 80,000
€80,000 - 91,000



For details of the charges payable in addition to the final Hammer Price of each Lot please refer to paragraphs 7 & 8 of the Notice to Bidders at the back of the catalogue.

368

2003 FERRARI 575 MARANELLO F1

Registration no. HX03 GMZ

Chassis no. ZFFBT55C000132365

- Fiorano handling pack
- 'F1' paddle-shift gearbox
- Full service history
- Recent full service (cam belts, clutch)
- Circa 62,900 miles recorded



'The Maranello needs no excuses: it is right-minded, a return to traditional values, albeit values and standards that tower high above those set by the Daytona when it shuffled off to extinction a quarter of a century ago.' – *Car* magazine.

Introduced for 2002, the Ferrari 575M (Modificata) represented an evolution of the acclaimed 550 Maranello rather than an entirely new model. With the introduction of the 550 Maranello in 1997, Ferrari had returned to its tradition of building front-engined V12 sports cars, resurrecting a line that had remained dormant since the demise of the 365GTB/4 'Daytona' in 1974. The heart of any Ferrari is its engine, and the 550 Maranello's 48-valve, 5.5-litre V12 developed 485bhp at 7,000rpm, some 100-or-so horsepower more than the Daytona's. Ferrari had discovered long ago that providing optimum balance in a front-engined sports car necessitated the use of a rear transaxle, and the Maranello's came with six speeds. The power train was housed in a tubular steel chassis, to which was attached aluminium coachwork, while the all-independent suspension incorporated dual-mode (normal/sports) damping, switch-selectable by the driver, which was complemented by speed-sensitive power-assisted steering.



Styled by Pininfarina like its illustrious 'Daytona' predecessor, the 550 Maranello was similarly proportioned, adopting the classical combination of long bonnet, small cabin and truncated tail. The body's aerodynamics were developed in the wind tunnel, where hours of testing ensured that the minimum of drag was combined with constant downforce regardless of set up, an important consideration in a 200mph road car.

Styling details such as the bonnet air scoop and hot air outlets behind the front wheelarches recalled the great competizione Ferraris of the past, in particular the immortal 250GTO, while the tail incorporated Ferrari's characteristic twin circular lights. For the 575M, engine displacement grew to 5,748cc and maximum power to 515bhp, while transmitting it to the ground was a new six-speed 'paddle shift' semi-automatic gearbox, a technology that Ferrari had developed in Formula 1. Traditionalists could still order a conventional six-speed gated manual 'box. When production ceased in 2005, 2,056 cars had been completed, of which 1,810 had the 'F1' transmission, 246 the manual alternative.

Finished in the rare and particularly handsome combination of Grigio Titano with Burgundy leather interior, this 575M Maranello was acquired by the vendor in September 2017 having been in the previous owner's possession for the preceding seven years. Unlike the majority of Maranellos, this car has the rare and desirable full Fiorano handling package for greatly enhanced on-the-road performance, an option that added some £17,000 to the purchase price. Other noteworthy features include factory 19" wheels, sports exhaust system, and a full leather-trimmed parcel shelf.

Carried out fewer than 3,000 miles ago, the last full service included changing the cam belts and clutch, while in February 2018 the car went to The Ferrari Centre of Parkwood, Kent for various minor issues to be addressed (bill on file). The car also comes with full service history consisting of the service booklet (13 stamps), numerous bills, and a quantity of expired MoT certificates. Having covered some 62,900 miles from new, this beautiful car represents a very rare opportunity to acquire a superb, low mileage example of one of Ferrari's best ever V12 Grand Tourers. It is surely one of the best examples of its type currently available and an excellent future investment. A worthy modern-day successor to the Ferrari 'Daytona'.

£70,000 - 80,000
£80,000 - 91,000

369

1928 BENTLEY 4½-LITRE TOURER

Coachwork by Park Ward

Registration no. UC 4791

Chassis no. NT3137

- One of 665 made
- Present ownership since 2003
- Restored in 2007
- Extensively campaigned



W O Bentley proudly debuted the new 3-Litre car bearing his name on Stand 126 at the 1919 Olympia Motor Exhibition, the prototype engine having fired up for the first time just a few weeks earlier. In only mildly developed form, this was the model which was to become a legend in motor racing history and which, with its leather-strapped bonnet, classical radiator design and British Racing Green livery has become the archetypal Vintage sports car.

Early success in the 1922 Isle of Man Tourist Trophy, where Bentleys finished second, fourth and fifth to take the Team Prize, led to the introduction of the TT Replica (later known as the Speed Model). However, by the middle of the decade the 3-Litre's competitiveness was on the wane and this, together with the fact that too many customers had been tempted to fit unsuitably heavy coachwork to the excellent 3-Litre chassis rather than accept the expense and complexity of Bentley's 6½-litre 'Silent Six', led to the introduction of the '4½'.



In effect, the new 4½-Litre model consisted of the chassis, transmission and brakes of the 3-Litre and an engine that was in essence two-thirds of the six-cylinder 6½-litre unit. Thus the new four-cylinder motor retained the six's 100x140mm bore/stroke and Bentley's familiar four-valves-per-cylinder, fixed-head architecture, but reverted to the front-end vertical camshaft drive of the 3-Litre. The 4½-Litre was produced for only four years, all but nine of the 665 cars made being built on the 3-Litre's 'Long Standard', 10' 10"-wheelbase chassis.

According to Clare Hay's authoritative work, *'Bentley: The Vintage Years'*, chassis number 'NT3137' was completed in February 1928 and fitted with engine number 'NT3138'. The original registration was 'UC 4791' and the first owner was one J Binning, who specified saloon coachwork by Gurney Nutting. Little is known regarding the early history of 'UC 4791', until it was purchased as an incomplete restoration project in September 2003 by the current vendor. As a Bentley enthusiast who has owned many WO Bentleys over the years, the vendor was able to progress the restoration swiftly utilising many spares he had accumulated during that time.

The chassis, running gear, and engine were overhauled, the latter receiving a new crankshaft, con-rods, pistons, camshaft, etc. The unnumbered front axle, rear axle, and the steering box, numbered T3021 where all overhauled with replacement components fitted as necessary.

Sporting original Weymann type open four-door coachwork by Park Ward, (previously fitted to another 4½-Litre), which benefits from a sympathetic older restoration. The vendor choose to enhance the long distance cruising capabilities of the Bentley by fitting a Laycock overdrive and substitution of one of the magnetos for a distributor/coil arrangement.

The restoration was completed in time for the 2007 touring season, the Bentley's first outing being on that year's New Zealand Tour. Since then it has completed a further two New Zealand Tours and participated in three South Africa Tours, 'Europe by Bentley', and the Spain/Portugal Tour. Sold only on account of the vendor's advancing years, the car is offered with sundry restoration invoices and a V5C Registration Certificate.

£250,000 - 280,000
€290,000 - 320,000



©Getty Images



1

370

The ex-Eon Productions and as featured in the Motion Picture 'GoldenEye' driven by Pierce Brosnan as James Bond
1965 ASTON MARTIN DB5 SPORTS SALOON

Chassis no. DB5/1885/R
 Registration no. FBH 281C (fitted with BMT 214A during Filming)

- Driven by James Bond (Pierce Brosnan) in Goldeneye
- Displayed at the Detroit and Los Angeles Motor Shows
- Extensively restored by Stratton Motor Company
- The most valuable piece of Bond memorabilia ever sold

Representing a wonderful opportunity for collectors, this beautiful Aston Martin DB5 featured in the famous opening scene of the motion picture *GoldenEye*, where secret agent James Bond (Pierce Brosnan) engages in a high-speed dice with arch villainess Xenia Onatopp (Famke Janssen) in her Ferrari F355 through the hills above Monaco.

1 (part lot)

Original 1995 cinema poster (71"x47").





Aston Martin has become synonymous with James Bond, and no model more so than the DB5, though it is not the first car from the British manufacturer to be associated with '007'. That honour falls to the DB Mark III, which was driven by Bond in Ian Fleming's novel, *Goldfinger*. The DB Mark III had been out of production for years when the movie franchise commenced, so Aston Martin's latest model - the DB5 - was used when *Goldfinger* was shot in 1964. Finished in Silver Birch and laden with M's latest gadgets, it has become the definitive James Bond Aston Martin, a status only enhanced by further appearances in *Thunderball* (1965), *GoldenEye* (1995), *Tomorrow Never Dies* (1997), *The World Is Not Enough* (1999), *Casino Royale* (2006), *Skyfall* (2012), and *Spectre* (2015). The DB5 thus became the only Aston Martin to be driven by three different Bonds: Sean Connery, Pierce Brosnan, and Daniel Craig.

Why an Aston Martin? As one of Her Majesty's secret agents, James Bond could hardly be expected to drive a foreign car, and as a connoisseur of the finer things in life, would not have accepted anything less than the very best. He might briefly have considered a Bentley Continental or Jaguar E-Type, before dismissing the 'Captains of Industry' Bentley as too middle-aged and the relatively affordable Jaguar as too commonplace. Aston Martin's DB5, though, ticked all the boxes: British, hand-built, exclusive and expensive, while at the same time exuding a youthful, high-performance image.

2 (part lot)
Original rare complete 1995 *GoldenEye* press pack.





The DB5 was a direct descendent of the first of this particular family of Aston Martins, the DB4, which had represented a giant step forward for the marque when it arrived in 1958. Classically proportioned, the Touring-designed body established an instantly recognisable look that would stand Aston Martin in good stead until 1970. The engine was still an all-alloy, twin-overhead-camshaft, six but the old W O Bentley supervised 3.0-litre unit had been superseded by a new design by Tadek Marek. The new 3,670cc engine featured 'square' bore and stroke dimensions of 92mm, and developed its maximum power of 240bhp at 5,500rpm. The David Brown gearbox was a new four-speed all-synchromesh unit.

Touring's Superleggera body construction (which employed a lightweight tubular structure to support the aluminium-alloy body panels) was deemed incompatible with the DB2/4-type multi-tubular spaceframe, so engineer Harold Beach drew up an immensely strong platform type chassis. The DB2/4's trailing-link independent front suspension gave way to unequal-length wishbones while at the rear the DB4 sported a live axle located by a Watts linkage instead of its predecessor's Panhard rod. Five series were built as the model gradually metamorphosed into the DB5. Introduced in July 1963, the Aston Martin DB5 boasted a 4.0-litre engine, this enlarged unit having been seen first in the Lagonda Rapide of 1961. Equipped with three SU carburettors, the '400' engine produced 282bhp at 5,500rpm and was mated to a four-speed/overdrive gearbox, a 'proper' ZF five-speed unit being standardised later.

The DB5's distinctive cowl headlamps had first appeared on the DB4GT and the newcomer was the same size as the lengthened Series V DB4. Outwardly there was little to distinguish the DB5 from the last of the DB4s apart from twin fuel filler caps, though these had already appeared on some cars. Beneath the skin however, there were numerous improvements including alternator electrics, Girling disc brakes instead of Dunlops, Sundym glass, electric windows and an oil pressure gauge as standard equipment.

From September 1964 the 314bhp, triple-Weber Vantage engine became available and was fitted to a total of 95 cars. The DB5 was also offered in convertible form (the 'Volante' name would not be applied to the soft-top Aston until the DB6's arrival) while independent coachbuilder Harold Radford offered a shooting brake conversion. 1,021 DB5s were manufactured between July 1963 and September 1965, a total that included 123 convertibles and 12 shooting brakes.



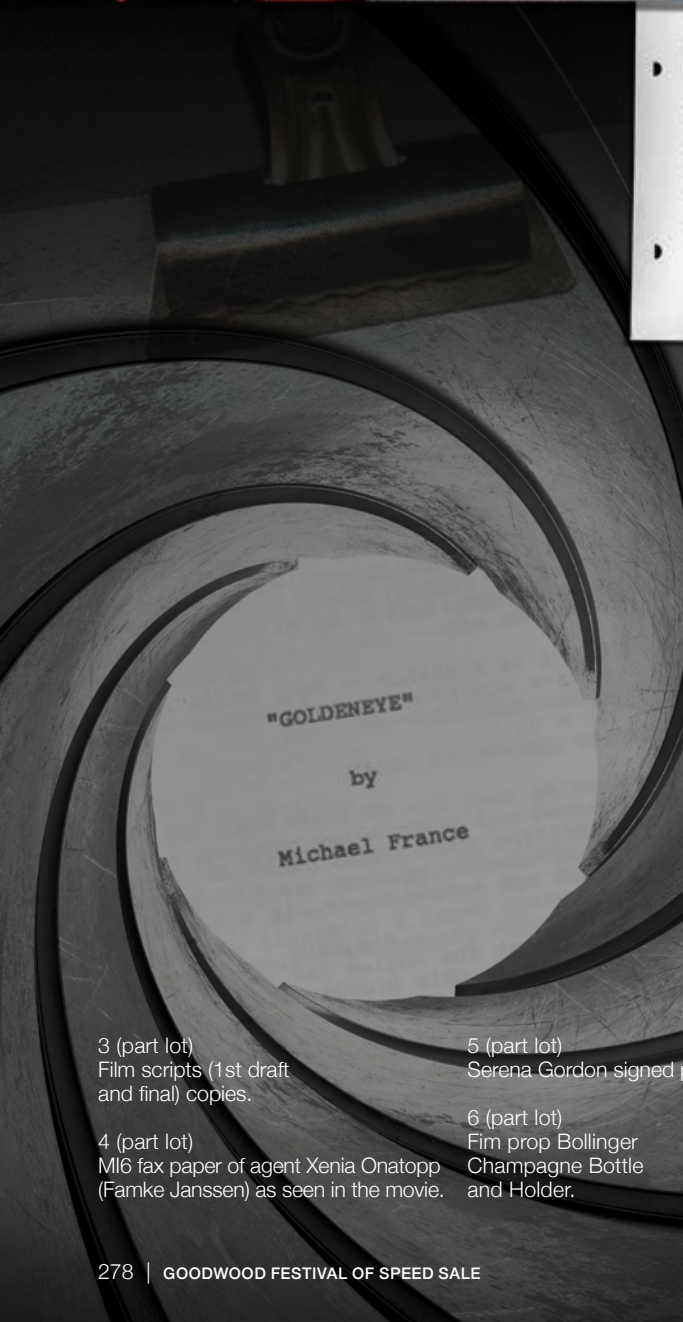
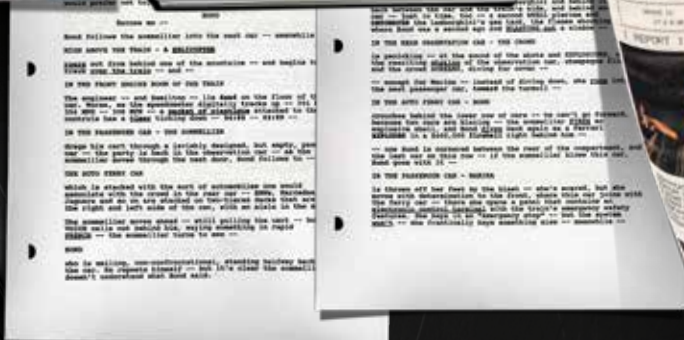

3 (part lot)
Film scripts (1st draft
and final) copies.

5 (part lot)
Serena Gordon signed photograph.

4 (part lot)
MIG fax paper of agent Xenia Onatopp
(Famke Janssen) as seen in the movie.

6 (part lot)
Film prop Bollinger
Champagne Bottle
and Holder.



Makers of *GoldenEye*, Eon Productions, contacted Aston Martin Lagonda for assistance in procuring the cars required for filming. Accordingly, AML instructed Stratton Motor Company to purchase two DB5s to be used for the driving sequences, while a third was borrowed for static filming in Monaco. Stratton prepared all three DB5s to identical cosmetic specification to avoid any continuity issues, while the driving-sequence cars were further modified to cope with the high-speed on-road stunts. The driving-sequence cars carried the registration 'BMT 214A'.

Rémy Julienne, a veteran of previous Bond films including *A View To A Kill*, co-ordinated the stunt driving, which on this occasion involved making two sports cars from starkly different eras - the Aston Martin DB5 and Ferrari F355 - appear evenly matched on screen. Eon Productions used '1885/R' for promoting *GoldenEye* once production had been concluded.

Bringing back the DB5 to the Bond franchise was well received by the World's press. There had been a gap of six years since the last film and 30 years since the appearance of an Aston Martin DB5 in the hands of 007. The dramatic opening scene of *GoldenEye* features one of the most memorable chase sequences. Performed along the Grande Corniche towards Monaco, James Bond (Pierce Brosnan) is accompanied by M16 colleague Caroline (Serena Gordon) having been sent by M to evaluate 007's performance. Whilst dicing with Xenia Onatopp (Famke Janssen) in her Ferrari F355, Bond has numerous hurdles and encounters to

overcome. The climax of the chase ends when Caroline orders Bond to stop the car, which he does in dramatic fashion and immediately produces a bottle of Bollinger from a custom made Champagne holder (included in this lot) inviting Caroline to toast to a "very thorough" evaluation.

Also included with the Champagne holder are a film prop Bollinger Champagne bottle, two Champagne flutes, Alpine stereo with colour fax paper, original 1995 cinema poster (71"x47"), original rare complete 1995 *GoldenEye* press pack, Serena Gordon signed photograph, original 1995 Empire and Flicks *GoldenEye* film review magazines and film scripts (1st draft and final) copies.

Aston Martin used '1885/R' to promote its new DB7 and this particular car was taken to the Detroit and Los Angeles Motor Shows where it was driven onto the stand by Sir Stirling Moss.

One of the two racing-sequence DB5s, '1885/R' was extensively restored by Stratton Motor Company both before and after filming. The latter rebuild included removing the body from the chassis and refurbishing it with a new nose section, new tail section and new door skins, which was followed by a full repaint in the current livery. It is understood that Stratton also carried out considerable mechanical refurbishment at this time.



9

In 1996, '1885/R' was sold to the immediately preceding owner, Peter Nelson, proprietor of the 'Cars Of The Stars' exhibition in Cumbria. When purchased at a Bond themed auction by the current owner in February 2001, this DB5 became the most valuable piece of Bond memorabilia ever sold and subsequently was recorded as such in the 'Guinness Book of World Records'. As a true James Bond DB5 it has brought with it unique experiences for the current custodian and his family, including attending Bond Premieres / after-show parties and even playing extras in the recent *Spectre* movie!

The DB5 has been well looked after, receiving occasional leisure use with service work provided by Aston Martin Works, RS Williams and Stratton Motor Company. The car featured in Chris Evans' Famous Five and Magnificent Seven car collection for BBC's *Children In Need 2013* Appeal and has been on display as the star exhibit at the National Motor Museum, Beaulieu, as well as the key attraction of the 'Bond in Motion' exhibition at London's Covent Garden.

The DB5 is one of the most recognisable and desirable British classic cars and also the ultimate Bond car. Every fan remembers Pierce Brosnan tearing through the hills in this car, which makes it something very special indeed in the history of both Aston Martin and the James Bond movie franchise. A unique opportunity.

£1,200,000 - 1,600,000
 €1,400,000 - 1,800,000



10

For details of the charges payable in addition to the final Hammer Price of each Lot please refer to paragraphs 7 & 8 of the Notice to Bidders at the back of the catalogue.

371

2009 LAMBORGHINI MURCIELAGO SV

Registration no. not UK registered
Chassis no. ZHWBE81H8ALA03817

- One of only some 185 made
- Delivered new to Italy
- Two owners
- Circa 17,000 kilometres from new
- Full Lamborghini service history
- Registered in Monaco





'So given that the 6.5-litre engine produces a thundering 663bhp at 8,000rpm and 487lb/ft at 6,500rpm, it's hardly surprising to discover that the performance is quite a long way the other side of impressive. Think 0-60mph in 3.2sec and 0-100mph in under seven and only then will you get an inkling of what it feels like to open the accelerator in second gear and hold it there for a while.' – *Autocar* on the Murciélago SV.

Successor to the Diablo and Lamborghini's flagship model, the Murciélago was introduced in 2001 for the 2002 model year, and like its forebears was named after a famous fighting bull. The Murciélago was Lamborghini's first new design for 11 years and also the Italian company's first since its acquisition by the Volkswagen Group's Audi division in 1998.

The angular, Luc Donckerwolke-styled coupé was very low, boasting a roof height of just under 1.2 metres, and featured distinctive 'scissor' doors that swung upwards and forwards when opened. A combination of carbon fibre, steel, and aluminium was used for the chassis/body, while the suspension featured the supercar-standard double wishbones all round.

The Murciélago's power unit was a longitudinally mounted 6.2-litre V12, an engine that could trace its ancestry back to the very first Lamborghini of 1964. As installed in the Murciélago, this formidable unit produced 572bhp, which was delivered to the ground via a six-speed manual gearbox and four-wheel drive, while an active rear wing and active air intakes, deployed automatically when required, helped keep the Murciélago stable at its circa 200mph top speed.

Roadster and up-rated LP 640 models followed, the latter powered by a 6.5-litre version of Lamborghini's long-running Giotto Bizzarrini-designed V12 and available with 'e-Gear' semi-automatic sequential transmission. Brakes that faded after repeated high-speed decelerations had been one of the original Murciélago's weaknesses, so the LP 640 could be ordered with carbon ceramic stoppers costing an additional £7,780.

There were various limited edition variations on the theme before the ultimate Murciélago – the LP 670-4 Super Veloce (SV) – made its debut at the Geneva Motor Show in 2009. As its nomenclature suggests, the LP 670 came with 670PS (661bhp) on tap, while its weight was significantly reduced by more extensive use of carbon fibre. Previously an option, the powerful carbon ceramic brakes with their six-piston callipers were standard on the SV.

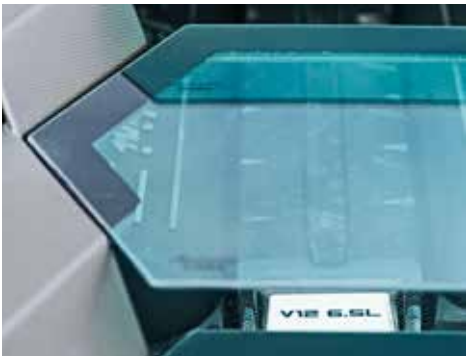

'You can sense the reduction in weight more than the increase in grunt in virtually everything the SV does, right down to increased power and response under brakes,' declared *Autocar*. 'Dynamically it takes the game at least one notch forward compared with the LP 640. Which is no mean achievement.'

Lamborghini claimed a top speed of 209mph (336km/h) for the Murciélago SV, though to realise the car's full potential it needed to be fitted with the optional smaller rear wing, in which case the fortunate driver could expect to see 212mph (341km/h) registering on the speedometer.

Production of 350 SVs was planned, though in the event only some 185 or so were completed out of a total Murciélago production of a little under 4,000 cars. Finished in white with black Alcantara interior, the example offered here - number '026' - was delivered new on 26th October 2009 via the Bologna Lamborghini concessionaire, Bull Car, to its first owner, based in Milan. Currently in the hands of only its second custodian, a lifelong supercar enthusiast, the Lamborghini has covered approximately 17,000 kilometres from new and is now registered in Monaco. Offered with full Lamborghini service history, it represents a wonderful opportunity to acquire a fine example of this very rare modern supercar.

£330,000 - 380,000
€380,000 - 430,000



For details of the charges payable in addition to the final Hammer Price of each Lot please refer to paragraphs 7 & 8 of the Notice to Bidders at the back of the catalogue.

THE FOLLOWING SIX CARS ARE THE PROPERTY OF A TITLED GENTLEMAN

372

1981 FERRARI 208 GTB

Coachwork by Pininfarina

Registration no. TDV 68W

Chassis no. F106CB33911

- *Rare Italian-market model*
- *One of only 160 made*
- *circa 70,000 kilometres from new*
- *Engine rebuilt 2015*
- *Registered in the UK*



In 1975 Ferrari had introduced a 2.0-litre version of the Dino 308GT4 - the 208GT4 - to take advantage of the Italian market's vehicle taxation system, and it did the same following the introduction of the successor 308 GTB and GTS models in 1980. The 208 GTB and GTS used the same V8 engine, which featured a reduced bore size of 66.8mm (from 81mm) for a capacity of 1,991cc and produced 155bhp at 7,700rpm. By the time they were superseded by Turbo versions in 1982, a total of 160 GTB and 140 GTS models had been completed.

First registered on 5th March 1981 in Italy, this 208 GTB remained in its home country until late 2014 when it was imported into the UK. On arrival, the car was checked over, serviced and MoT'd. In February 2015, the engine was removed, stripped, and rebuilt, including replacement of the cam belt and gearbox oil. On file, the related invoice for over £9,000 details the parts and labour involved.

In March 2015, the Ferrari was registered to its sole UK keeper. During 2015, the nearside front shock absorber and bushes were replaced, and the steering rack rebuilt, followed by alignment of all four wheels.

Finished in Rosso Corsa with Nero Connolly leather interior, this car is equipped with air conditioning, electric windows, radio/cassette, and a Nardi steering wheel. It sits on correct Cromodora 14" alloy wheels, which are shod with appropriate Michelin XWX tyres. Presented in generally very good original condition, this rare Ferrari model comes complete with tool kit and spare wheel, and is offered with a UK V5C registration document and MoT until May 2019.

£45,000 - 50,000

€51,000 - 57,000

373

1965 FORD LOTUS CORTINA COMPETITION

Chassis no. BA74EG59563

- Race prepared
- Original engine
- Well documented
- FIA and MSA papers



One of only 3,306 Mk1 Lotus Cortinas produced between 1963 and 1966, this example was built in August 1965 at the Dagenham factory. Within the history file is a FIA Historic Vehicle Passport dated September 1990, which states that the Cortina was restored in 1989 and contains various photographs and details of the car from that period. There is also a more recent MSA Historic Technical Passport dated July 2008 for FIA class: CT8, period: F - 1962 to 1965. An engine dynamometer printout is available also, showing the maximum output as an impressive 162bhp.

Between 2006 and 2009 the car was driven by Mr Richard Lawson in such events/venues as the Grand Prix De L'Age d'Or at Dijon, Spa 6 Hours, and Knockhill. There are numerous lap charts and set-up data sheets dating from this period recording suspension settings, session times, race results, etc - the car being looked after by Martin Stretton Racing, Worcestershire.

The car is finished the iconic Lotus works-entry colour scheme of Ermine White and Sherwood Green. Following many years of on-track use, the bodyshell and paintwork have acquired a charming 'competition car' patina. However, we are advised that there are no major rust issues to be found, and all the alloy panels are still present and correct.

As one would expect, the interior is to competition specification complete with roll cage, Cobra Evolution racing seat, Luke 4-point safety harness, and a period-style Moto-Lita steering wheel. For weight saving purposes the passenger seat has been removed, while a lightweight racing battery has been fitted together with a fire extinguisher in the foot well.

The Cortina is equipped with the original 1,558cc Lotus/Ford Twin-Cam wet-sump engine, which breathes via twin Weber carburetors fed by an electrical fuel pump. We are advised that the four-speed synchromesh gearbox feels tight and precise to operate throughout the gears and rev range. The wheels are 13" Minilite-style alloys finished in silver, shod with a matching set of period-style Dunlop racing tyres with plenty of tread remaining.

£30,000 - 40,000
€34,000 - 46,000

374

1991 FERRARI TESTAROSSA COUPÉ

Coachwork by Pininfarina

Registration no. to be advised

Chassis no. ZFFAA17B000077224

- *Delivered new in Europe*
- *Left-hand drive*
- *Correct Tipo F113B engine*
- *Recent extensive re-commissioning*
- *Offered from a large private collection*





Ferrari's flagship model in its day, the Testarossa supercar revived a famous name from the Italian company's past when it arrived in 1984. A 'next generation' Berlinetta Boxer, the Testarossa (red head) retained its predecessor's amidships-mounted, 5.0-litre, flat-12 engine, which now boasted a maximum power output raised to 380bhp at 6,300rpm courtesy of four-valve cylinder heads. Despite the power increase, smoothness and driveability were enhanced, the car possessing excellent top gear flexibility allied to a maximum speed of 180mph.

Rivalling Lamborghini's Countach for presence, the Pininfarina-designed Testarossa succeeded brilliantly, the gill slats feeding air to its side-mounted radiators being one of the modern era's most instantly recognisable – and copied - styling devices. A larger car than the 512BB - the increase in width being necessary to accommodate wider tyres - the Testarossa managed the trick of combining high downforce with a low coefficient of drag, its graceful body being notable for the absence of extraneous spoilers and other such devices. Despite the increase in size over the 512BB, the Testarossa was lighter than its predecessor, the body - its steel doors and roof excepted - being, somewhat unusually for a production Ferrari, of aluminium. Luxury touches in the well-equipped cabin included air conditioning, electrically adjustable seats, tilting steering wheel and plentiful leather.

Unlike some of its rivals, the Testarossa possessed light controls and was relatively easy to drive, factors which, allied to its outstanding performance and stunning looks, contributed to an instant and sustained high level of demand. Even when new, Testarossas changed hands for substantial premiums over list price in the late 1980s.

A Europe-delivered model with the correct Tipo F113B engine, this Testarossa was exported to Japan at some time, seeing little use there, and was purchased by the current vendor in May 2015. Since arriving in the UK, it has been extensively re-commissioned by Lights Cars Action of Bordon, Hampshire. This re-commissioning included engine removal, replacement of cam belts, new clutch, overhauling brake callipers, new fuel pumps and hoses, new electric window motors, new distributor caps and HT leads, reconditioned starter motor, replacement brake master cylinder, etc. LCA's bill for £17,676 is on file and the car also comes with a current MoT certificate and UK V5C registration document. Even today few cars can match the on-road presence of a Testarossa, and this example represents a rare opportunity to acquire one of these high-performance works of art.

£80,000 - 100,000
€91,000 - 110,000

375

2007 PORSCHE 911/997 TURBO S CABRIOLET

Registration no. to be advised
Chassis no. WP0ZZZ99Z8S786554

- Supplied new in the UK
- Right-hand drive
- One owner
- Circa 25,500 miles from new
- All books and tools



'This car needs little introduction. It is the latest version of the most famous sports car of all time, continuing a tradition of turbocharged 911s that began in 1975. For 25 years the 911 Turbo has been the most expensive car in the range.' – *Autocar*, 12th July 2000.

Much of the Porsche 911's development had resulted from the factory's racing programme, and it was the then Group 4 homologation rules, which required 400 road cars to be built, which spurred the development of 'Project 930' - the legendary 911 Turbo. In production from April 1975, the Turbo married a KKK turbocharger to the 3.0-litre Carrera RSR engine, in road trim a combination that delivered 260bhp for a top speed of 155mph. But the Turbo wasn't just about top speed, it was also the best-equipped 911 and amazingly flexible - hence only four speeds in the gearbox - being capable of racing from a standstill to 100mph in 14 seconds.

What set the 911 Turbo apart from its peers was the relaxed way this stupefying performance was delivered. Comparing the Turbo to similarly quick 'he-man' cars such as the Holman & Moody-tuned Cobra 427 and the Ford GT40, Motor's Roger Bell reckoned what made the Porsche so different was that it 'hurls you forward with similar velocity but in an uncannily quiet and effortless way. To be shoved so hard in the back that you need high-back seats to keep your head on, yet neither to feel nor hear anything more than a muffled hum, is a very odd sensation indeed in a car.'

The Turbo's characteristic flared wheelarches and 'tea tray' rear spoiler had already been seen on the Carrera model, while the interior was the most luxurious yet seen in a 911, featuring leather upholstery, air conditioning and electric windows. More refined than hitherto yet retaining its high performance edge, the Porsche 911 Turbo sold in the thousands, becoming the definitive sports car of its age.

Representing a major step forward, the Type 996 version, introduced in 1997, really did justify its maker's claims to be 'all new'. With the 996's introduction, Porsche finally adopted water cooling for the flat-six engine, which remained behind the rear wheels of a car that shared no panels with its immediate predecessor and was longer, wider, and higher than before. Devotees of the 911 Turbo had to wait a few years before they could get their hands on the 996 version, which did not arrive until the autumn of 1999. The new 3.6-litre Turbo engine was derived from that of the GT3 sports-racer, featuring twin turbochargers, and now developed its maximum of 414bhp at a relatively low (for a sports car) 6,000 revs, with 413lb/ft of torque available from 2,700 to 4,600rpm.



As usual, the Turbo was styled more aggressively, with a wider body, broader rear wing, and air intakes in the front bumper and ahead of the rear wheels. Like its predecessor, the new Turbo was only available with all-wheel drive.

Not surprisingly, given the Type 996's wholesale re-engineering, the successor Type 997 - introduced in 2004 - represented evolution rather than revolution, the most significant changes being to the interior and exterior styling. The latter marked a welcome return to the 911's traditional oval headlights, and the interior too was more classic 911 than that of the outgoing 996. The base 3.6-litre engine remained essentially the same as the Type 996's, while the more expensive 'S' models came with a more powerful 3.8-litre unit. The Turbo, though, kept the '3.6', which now featured Variable Turbine Geometry (VTG) turbo-chargers for better throttle response. As is the case with many modern auto 'boxes, Porsche's Tiptronic got the Turbo off the line quicker than the manual-transmission version, the former racing to 100km/h in 3.7 seconds compared with the latter's 3.9.

In developing the Type 997, Porsche had started with the more challenging cabriolet version, reasoning that if the open car could be made sufficiently stiff, the coupé would easily achieve the required rigidity. The Turbo Cabriolet was announced in May 2007, with deliveries commencing in September of that year. Open cars typically suffer an inferior performance when compared with their closed cousins, but not the Turbo Cabriolet, which gave next to nothing away to the Type 997 Coupé, its maximum speed being around 310km/h (193mph).

The rare right-hand drive Turbo Cabriolet offered here has the Tiptronic automatic transmission and is finished in back with matching leather interior. Accompanying documentation consists of current MoT to June 2019, expired MoTs, Porsche Handbook and a V5C Registration Certificate. One of the fastest convertible sports cars ever produced, this beautiful Turbo Cabriolet represents a wonderful opportunity to acquire one of these exclusive Type 997 models that can only become increasingly collectible.

£60,000 - 70,000
£69,000 - 80,000

376

2005 PORSCHE 911 TYPE 996 TURBO S COUPÉ

Registration no. to be advised
Chassis no. WPOZZZ99Z5S680090

- Supplied new in the UK
- Right-hand drive
- One owner
- Factory option 996 Turbo Aerokit example
- Circa 15,000 miles



Much of the Porsche 911's development had resulted from the factory's racing programme, and it was the then Group 4 homologation rules, which required 400 road cars to be built, which spurred the development of 'Project 930' - the legendary 911 Turbo. In production from April 1975, the Turbo married a KKK turbocharger to the 3.0-litre Carrera RSR engine, in road trim a combination that delivered 260bhp for a top speed of 155mph. But the Turbo wasn't just about top speed, it was also the best-equipped 911 and amazingly flexible - hence only four speeds in the gearbox - being capable of racing from a standstill to 100mph in 14 seconds.

What set the 911 Turbo apart from its peers was the relaxed way this stupefying performance was delivered. Comparing the Turbo to similarly quick 'he-man' cars such as the Holman & Moody-tuned Cobra 427 and the Ford GT40, Motor's Roger Bell reckoned what made the Porsche so different was that it 'hurls you forward with similar velocity but in an uncannily quiet and effortless way. To be shoved so hard in the back that you need high-back seats to keep your head on, yet neither to feel nor hear anything more than a muffled hum, is a very odd sensation indeed in a car.'

The Turbo's characteristic flared wheel-arches and 'tea tray' rear spoiler had already been seen on the Carrera model, while the interior was the most luxurious yet seen in a 911, featuring leather upholstery, air conditioning and electric windows. More refined than hitherto yet retaining its high performance edge, the Porsche 911 Turbo sold in the thousands, becoming the definitive sports car of its age.

Representing a major step forward, the Type 996 version, introduced in 1997, really did justify its maker's claims to be 'all new'. With the 996's introduction, Porsche finally adopted water cooling for the flat-six engine, which remained behind the rear wheels of a car that shared no panels with its immediate predecessor and was longer, wider, and higher than before. Despite the overall increase in size, Porsche's engineers managed to lower the 996's drag co-efficient by raking back the windscreen, achieving a figure of 0.30 (down from the 993's 0.34) with a beneficial reduction in fuel consumption at high speeds. Bonded-in front and rear screens contributed to a significant increase in the stiffness of the aluminium chassis, which was clad in galvanised steel body panels. Water radiators were mounted at the front: two for manual transmission cars, three for those with the Tiptronic semi-automatic 'box.



The new, more compact, 24-valve engine displaced 3.4-litres compared with the 993's 3.6 yet contrived to be more powerful, producing 300bhp (up from 285), which was good enough for a top speed of 174mph. Inside, the 996's new dashboard represented another major departure from tradition, being considerably more complex than anything seen hitherto in a 911, boasting a 'PCM' (Porsche Communication Management) centre console incorporating controls for the radio, air conditioning, multi-function computer, car 'phone and satellite navigation.

Devotees of the 911 Turbo had to wait a few years before they could get their hands on the 996 version, which did not arrive until the autumn of 1999. The new 3.6-litre Turbo engine was derived from that of the GT3 sports-racer, featuring twin-turbos, and now developed its maximum of 414bhp at a relatively low (for a sports car) 6,000 revs, with 413lb/ft of torque available from 2,700 to 4,600rpm. As usual, the Turbo was styled more aggressively, with a wider body, broader rear wing, and air intakes in the front bumper and ahead of the rear wheels.

Like its predecessor, the new Turbo was only available with all-wheel drive. Towards the end of Type 996 production, and with the new 997 just over the horizon, Porsche announced a more powerful Turbo - the 'S' - which had a mighty 444bhp and 457lb/ft at its disposal, figures rivalling those of the fearsome GT2. With a top speed knocking on 200mph, the Turbo S well deserved its inclusion in the supercar ranks.

The current vendor purchased this Turbo S from the Roland Hall dealership in Gerrard's Cross, Buckinghamshire with only delivery private mileage recorded. Since then the car has formed part of his large private collection and been serviced by RW Autos of London SE1. In recent years the Porsche has been stored at Roger Bennington's Stratton Motor Company, and has covered only some 15,000 miles from new. Offered with its original book pack (including service booklet), original tools, current MoT, and V5C document, this beautiful Turbo S represents a rare opportunity to acquire one of these exclusive, last-of-the-line Type 996 models that can only become increasingly collectible.

£60,000 - 70,000
€69,000 - 80,000

377

1970 JAGUAR E-TYPE SERIES 2 ROADSTER

Registration no. OCL 300H

Chassis no. 1R1607

- *Original UK-delivered right-hand drive model*
- *Three owners from new*
- *An older restoration, well maintained*
- *Recent extensive works*





Introduced in 3.8-litre form in 1961, the Jaguar E-Type caused a sensation when it appeared, with instantly classic lines and 150mph top speed. Its design owed much to that of the racing D-Type: a monocoque tub forming the main structure while a tubular spaceframe extended forwards to support the engine. The latter was the 3.8-litre, triple-carburettor, 'S' unit first offered as an option on the XK150. An optimistic 265bhp was claimed, but whatever the installed horsepower, the E-Type's performance did not disappoint; firstly, because it weighed around 500lb (227kg) less than the XK150 and secondly because aerodynamicist Malcolm Sayer used experience gained with the D-Type to create one of the most elegant and efficient shapes ever to grace a motor car. In 1965 the 4.2-litre version arrived boasting a more user-friendly gearbox with synchromesh on first gear alongside the bigger, torquier engine.

Proposed changes in United States automobile legislation would eventually result in the revised Series 2, announced in October 1968, though modifications began to be phased in during 1967. Externally, the Series 2 was readily identifiable by its larger sidelights, raised bumpers, deleted headlight covers, twin reversing lights, and square rear number plate, while the interior was revised with rocker-type dashboard switches, new seats, and a collapsible steering column. Beneath the skin, Ad-West power steering, Girling brake callipers, and an up-rated radiator were among the Series 2's many mechanical improvements.

This Series 2 roadster was purchased new by one Lewis Essex of Richmond, Surrey on 23rd June 1970, and some 20 years later, on 1st April 1990, was sold to John Hume of London. Used regularly and well maintained by Mr Hume, it was purchased by the current vendor in December 2014. Before then, in 1991, the E-Type had been restored, both cosmetically and mechanically, by Mill Lane Engineering of Farnham, Surrey (bills on file). In 1999 the engine was rebuilt again, on this occasion by Jaguar specialists W&S Autos of Chobham, Surrey, who have continued to maintain the car ever since. New MWS wire wheels were fitted in 2000.

Further extensive works were carried out by W&S following the vendor's purchase (see bill for circa £20,000 on file) and the E-Type is presented today in beautiful condition, driving very well. The car is offered with its 'Operating, Maintenance and Service' handbook; current MoT; UK V5C Registration Certificate; and the aforementioned restoration and maintenance bills.

£100,000 - 120,000

€110,000 - 140,00

END OF COLLECTION

For details of the charges payable in addition to the final Hammer Price of each Lot please refer to paragraphs 7 & 8 of the Notice to Bidders at the back of the catalogue.

FURTHER PROPERTIES

378

2016 PAGANI HUAYRA COUPÉ

Registration no. HU16 YRA

Chassis no. ZA9H11EAYYSF76109

- *One of the world's fastest supercars*
- *One of only 100 built*
- *One of only 4 UK supplied cars*
- *Right-hand drive*
- *7,650 miles from new*





'It's a car with its own personality – or rather its own split personality. Beyond refinement and ease of use is a demon with one eye open waiting for its turn, a car that is scintillatingly fast and hugely demanding, a car that can thrill and terrify in equal measure, a supercar in every sense of the word.' – *Evo*.

One of the more fascinating aspects of the modern motoring scene is the recent emergence of the small independent supercar manufacturer, many of which have gone from relative obscurity to the status of household names in just a few short years, usually on the back of a product range offering hitherto almost unimaginable levels of performance. Whereas at one time established manufacturers such as Ferrari, Lamborghini, Porsche, Mercedes-Benz, and Aston Martin only had one another to worry about, they now have to contend with the likes of Koenigsegg, Spyker, Noble, Ultima and, of course, Pagani.

Succeeding the Zonda, Pagani's latest offering is the Huayra, a mid-engined coupé hailed by *Top Gear* magazine as 'Hypercar of the Year 2012'. Horacio Pagani was no newcomer to the world of automotive engineering when he built the first Zonda in 1999, for the Argentine-born industrial design graduate had been working with Lamborghini since the mid-1980s, developing the Countach and Diablo road cars and assisting with the Italian manufacturer's Formula 1 engine programme.

The Zonda C12 debuted in coupé form at the 1999 Geneva Motor Show, its maker freely acknowledging that its styling had been inspired by the Mercedes-Benz Group C 'Silver Arrow' sports-racers. Mercedes-Benz's influence was more than just skin deep, for the German firm's AMG performance division was responsible for the Zonda's 6.0-litre V12 engine, which was mounted longitudinally amidships in the predominantly carbon fibre body tub. With some 408 horsepower on tap, the C12 was always going to be quick, but performance figures of 0-60mph in 4.2 seconds and 0-100 in 8.2 were simply staggering plus, of course, that all important 200mph (or thereabouts) top speed.

Seemingly small from the outside yet endowed with a comfortable cabin, the C12 provided the basis for a host of derivatives, which emerged from Pagani's factory at San Cesario sul Panaro near Modena (where else?) in strictly limited numbers over the next 11 years.

Its successor, the Huayra - named after a wind God of the South American Quechua people - made its public debut at the Geneva Motor Show in March 2011. Once again, AMG provided the engine, on this occasion a twin-turbocharged 6.0-litre V12 producing a mighty 620bhp and a titanic 737lb/ft of torque. A mind-boggling top speed of around 238mph (383km/h) was claimed for the Huayra, with the 0-60mph dash accomplished in a neck-snapping 2.8 seconds.

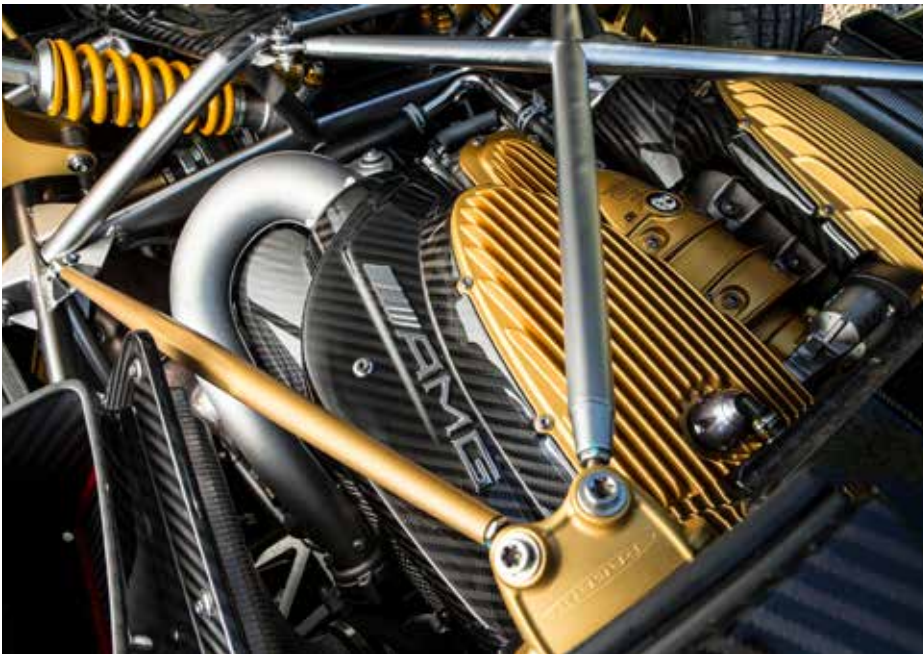

Power reaches the road via a transversely-mounted Xtrac seven-speed sequential semi-automatic transmission, while the stupendous performance is kept in check by Brembo carbon ceramic disc brakes featuring four-pot callipers all round. It is worthwhile noting the Horacio Pagani chose to stick with a conventional single clutch rather than the more complex and heavier twin-clutch technology favoured by some rivals, reasoning that the considerable saving in weight would result in a better-balanced car.

The most significant difference between the Huayra and its Zonda predecessor is the former's use of active aerodynamic aids. These consist of variable front ride height and moveable spoilers at front and rear, their deployment being managed by a dedicated control unit to minimise drag or maximise downforce as required. Under hard braking, the rear spoiler flaps function as an air brake, the front ride height being increased at the same time to counteract weight transfer to the front wheels and thus maintain stability.

Cleverly, this system is also used to limit body roll when cornering by raising the 'inside' flaps to generate increased down force on that side only. As had been the case with the Zonda, an open roadster and various limited-edition variants followed.

Testing a Huayra in 2013, *evo* magazine found that even before the ignition key had been turned, the experience of just sitting in the cockpit was almost overwhelming. 'Inside a leather, carbon fibre and aluminium cocoon of obsession, every detail agonised over and beautifully thought out, every material used sympathetically and expertly integrated into this stunning sculpture. The driving position is superb.' Needless to say, the driving experience did not disappoint: '...the engine is just phenomenally powerful and when it's delivering the full 737lb/ft of torque, it scrambles your brain. This is the sort of performance that doesn't dull even with prolonged exposure'.

Pagani's agreement with AMG limited the supply of engines to 100 units, restricting production of the Huayra Coupé to only 100 cars, thus guaranteeing the Huayra's instant exclusivity and future collectible status. This rare right-hand drive Huayra was delivered new in May 2016 to the current owner via Pagani's UK base in Park Royal, London, making it one of only 4 UK supplied cars.



Before leaving the factory, the inside of the clamshell was signed by the Pagani family and the Pagani factory staff who built the car before the final clear coat was applied. In July 2016, '109' was back at Pagani UK where a Pagani-specification Cobra Cat 5 tracker was supplied and fitted, and a full car paint protection film kit applied at an additional cost of £11,271. Bills relating to the Huayra's supply and subsequent upgrading are on file together with one for the car's first annual service, carried out in December 2016. We are advised by the private vendor that the Huayra has spent some four months back at the Pagani factory in Modena being readied for sale, and is in effectively 'as new' condition throughout. It is also offered with its private registration 'HU16YRA'.

In short: what we have here is a state-of-the art modern supercar, with one owner from new, prepared for sale by the factory and presented in immaculate condition, ready to delight its fortunate next

£1,300,000 - 1,600,000

€1,500,000 - 1,800,000

SPECIFICATION LIST

- Sonus Fabar Sound System
- Carbon Ceramic Brakes
- Inconel Titanium Exhaust System
- Front Vehicle Lifting System
- Bluetooth Hands Free System
- Tyre Repair Kit with Wheel Socket Adaptor
- Paint Layout 2 - Exposed Carbon Fibre & Paint
- Metallic Paint (Plus Option Multi-Layer Paint - Blu Francia)
- Exposed Carbon Fibre Nose
- Exposed Carbon Fibre Front Splitter
- Huayra Style Wheels - Liquid Silver Finish
- Standard Calliper Colour - Black
- Exterior Metal Features - Titanium
- Parking Sensors
- Pagani Premium Leather Interior - Black Malvec & Grey Ardesia
- Two Tone Interior Layout as per 'PT1' car
- Contrast Stitch - Black
- Seat Belts - Black
- Interior Metal Features - Titanium Finish

Horacio Pagani

379

**2014 LAND ROVER DEFENDER SVX
'SPECTRE' 4X4 UTILITY**

Registration no. OO07 SVX

Chassis no. to be advised

- *Used in the filming of the James Bond movie Spectre (2015)*
- *One of ten built*
- *Based on a Defender 110 crew-cab model*
- *Extensively modified and upgraded by Land Rover SVO*





www.007magazine.com/SPECTRE © 2015
Danjaq, LLC, Metro-Goldwyn-Mayer Studios Inc.



www.007magazine.com/SPECTRE © 2015
Danjaq, LLC, Metro-Goldwyn-Mayer Studios Inc.



www.007magazine.com/SPECTRE © 2015
Danjaq, LLC, Metro-Goldwyn-Mayer Studios Inc.



Representing arguably the ultimate version of Land Rover's iconic Defender, the example offered here was used during the filming of the 24th and latest film of the James Bond franchise, *Spectre*, set in the Austrian Alps and released in 2015. *Spectre* is the seventh James Bond film to feature a Land Rover, the first being *Octopussy* (1983).

SPECTRE (SPecial Executive for Counterintelligence, Terrorism, Revenge and Extortion) first appeared in Ian Fleming's James Bond novel *Thunderball* (1961) and in the film *Dr No* (1962) led by supervillain Ernst Stavro Blofeld. Clearly, the operatives of such a criminal organisation would need their own specially adapted vehicles to cope with the Alpine terrain, so Sony Pictures contacted Jaguar Land Rover's Special Vehicle Operations division to supply ten Defenders.

In its standard form the friendly and familiar Defender would have lacked the aura of menace required for the SPECTRE vehicles, so the ten movie cars were sent to marque specialists Bowler, a company recognised for over 30 years as market leaders in the design, engineering, and production of class-leading custom vehicles. Bowler then transformed them from standard Defender 110 crew-cab models into vehicles worthy of a Bond villain. Finished in sinister Santorini Black, the result was the SVX, or Spectre Defender.

The transformation's most striking element is the huge 37"-diameter all-terrain tyres, which has given the Spectre Defender the nickname 'Bigfoot'. Built to Bowler's racing specification, the suspension incorporates Rose joints and Bilstein rally dampers. The interior features Recaro seats with 4-point harnesses, while the full roll cage runs both internally and externally. The engine too has been significantly upgraded, producing 185bhp (up from the stock 120 horsepower) and 368lb/ft of torque.



Unlike most of the other Spectres, which were used only for publicity purposes or not at all, this example was used extensively in the filming and still has marks on its bonnet left by the stuntmen. Unusually, it retains its mechanical handbrake and 'SVX' boot badges (most of the other vehicles had theirs removed) and also key tags identifying it as an official film car, etc. The first private owner had the pick of all ten Spectre Defenders and chose this one as it is the most significant.

Representing a possibly once-in-a-lifetime opportunity to acquire one of the most memorable 'Bond' vehicles of recent times, this imposing Spectre Defender is offered with the owner's wallet containing the handbook and (blank) service booklet; current MoT certificate; UK V5C document for the most appropriate registration '0007 SVX'; and a framed presentation featuring movie stills, the shooting schedule, and an Austrian licence plate.

£220,000 - 250,000
 €250,000 - 290,000



1958 MERCEDES-BENZ 220SE 'PONTON' COMPETITION SALOON

Registration no. RSG 395
Chassis no. 180010Z8502794

- All Goodwood Revival meetings since 2008
- 2.8-litre engine
- Built by Tipton Garage
- Maintained by INRacing



This Mercedes-Benz 220S enjoys the distinction - together with the Mercedes-Benz 300SE 'Fintail' saloon in this sale (Lot 362) - of having attended all Goodwood Revival meetings since its construction in 2008. Like the 300SE, this rare right-hand drive 'Ponton' was race-prepared for the same owner - a prominent Mercedes-Benz collector and marque expert - by motor engineer Richard Miles of Tipton Garage, a former Brabham Formula 1 mechanic and Daniel Richmond's right-hand man at legendary tuners, Downton Engineering. Richard's brief was to build the 'Ponton' for use at the Goodwood Revival and HRDC 'Touring Greats' series, which share regulations, while taking advantage of all permitted modifications. The latter include an increase in engine capacity of up to 25%, and so a 2.8-litre engine was installed, which drives via a four-speed manual gearbox from the same period. Both engine and transmission, the latter upgraded with a limited-slip differential, were painstakingly rebuilt at Tipton Garage by Richard's son, Stephen Miles, a former development engineer at Janspeed Engineering where he was a key member of the team responsible for running Nissan's works effort in the British Touring Car Championship.

To satisfy the FIA's safety regulations for historic competition cars, a custom-built full roll cage has been installed together with all the mandatory safety equipment.

Goodwood's particular insistence on the retention of period features on historic saloons meant that the Mercedes had to have factory steel wheels and full interior trim. Like that of its 'Fintail' stablemate, this car's attention to detail has seen it acknowledged as one of the best presented entries at the Goodwood Revival, even impressing visiting directors of Mercedes-Benz.

Motor sports legends that have co-driven this car at Goodwood include Desiré Wilson, Jürgen Barth, Jochen Mass, and Brian Redman. 'RSG 395' has also been welcome in the HRDC's popular 'Touring Greats' series for pre-1960 touring cars and will surely remain so for the foreseeable future. During this period, the car was always maintained regardless of cost by Tipton Garage, who kept it in first class order.

When the owner/driver retired from active participation in motor sports, both of his historic Mercedes-Benz racers were purchased by the current vendor. The current owner acquired the car in January 2016 and is only offering it for sale today for medical reasons. This Mercedes (and its 300SE stablemate) has been maintained to a very high standard by Ian Nuthall's 'INRacing', specialists in historic competition cars of all kinds, and is presented in ready-to-race condition. This well-known Mercedes-Benz racing saloon represents a wonderful opportunity to own a car having one of the longest associations with Goodwood's much loved Revival meeting.

£38,000 - 44,000
€43,000 - 50,000

381

The ex-Baroness Thatcher

2010 JAGUAR XJ8 LWB 'ARMOURED' SALOON

Registration no. LX10 BZK

Chassis no. SAJAC91P76SH11143

- *Supplied by Jaguar Cars Limited directly to the British Government*
- *Also used by former Prime Minister, The Rt Hon David Cameron MP*
- *Armoured specification*
- *Automatic transmission*
- *Circa 22,70 miles from new*
- *Recently serviced*



Offered here is the last official car used by former Prime Minister, the late Baroness Thatcher, who held the United Kingdom's highest office of state from 1979 to 1990. She was the UK's first woman Prime Minister and its longest serving of the 20th Century.

There were many official cars used by Margaret Thatcher during her time in office as Prime Minister and subsequently as ex-Prime Minister, but this Jaguar is the only official car used by her that can be substantiated. All of the previous official cars went through secure disposal and are no longer in existence. The Jaguar was loaned to Conservative Party leader David Cameron during the 2010 parliamentary election, and was seen on television screens around the world when Mr Cameron left Buckingham Palace on his way to 10 Downing Street following his audience with HM The Queen.

'LX10 BZK' is an armoured XJ8 that was supplied directly by Jaguar Cars Limited to the Government Car and Despatch Agency (GCS). Powered by a 4.2-litre V8 engine driving via a six-speed automatic transmission, the car is finished in Liquid Silver with Charcoal-piped Ivory leather interior.

The latter features an in-car telephone and a multimedia system including audio and a DVD player, with a video display screen in the rear of each front headrest. Additional armoured protection includes a titanium roof, ballistic steel armouring, under-floor Kevlar layer, and bullet-resistant boro-silicate glazing. The braking system features Alcon mono-block brake callipers (six-piston front, four-piston rear), high-performance brake pads, and ventilated discs, while the suspension incorporates specially strengthened Bilstein B46 dampers and bespoke high-strength silicon-alloy Eibach springs. Tyres are of the 'run flat' type.

The current vendor purchased the ex-Thatcher Jaguar at a UK auction in 2016. Recently serviced at Lookers Jaguar, West London, the car currently displays a total of only some 22,700 miles on the odometer and is presented in commensurately excellent condition. Accompanying documentation consists of a Statement of Authenticity signed by the then Secretary of State, Patrick McLoughlin; a Jaguar XJ Armoured brochure; owner's wallet containing handbooks and service book (unstamped); MoT to September 2018; and a V5C Registration Certificate recording the previous keeper as GCS, 306 St James's Rd, London SE1.
£25,000 - 35,000
€28,000 - 40,000

382

1962 MERCEDES-BENZ 190 SL ROADSTER

Chassis no. 115 FWP
Engine no. 12104020023695

- *Delivered new in the UK*
- *Original book pack*
- *Professionally restored in 2006/2007*
- *Re-sprayed and re-trimmed within the last seven years*
- *Superb condition*





'It proved to be fast and tireless, exhilarating to drive and was probably created with long distance, comfortable travel in mind...' - *Autocar* on the Mercedes-Benz 190 SL, 10th January 1956.

For those insufficiently wealthy to afford its hyper-expensive race-bred 300 SL, Mercedes-Benz offered the less exotic but no less refined 190 SL, which shared the same wheelbase as its big sister and broadly similar styling. Announced in 1954 and based on the 180 saloon whose all-independently-suspended running gear it retained, the 190 SL did not enter production until January 1955, the delay being caused by alterations aimed at strengthening the saloon's shortened platform to compensate for the open body's reduced stiffness. 'Very few new sports cars have been so eagerly awaited or so long in coming as the moderately priced SL version of the Mercedes-Benz,' observed *Road & Track* magazine.

Mounted on a detachable sub-frame together with the four-speed manual gearbox, front suspension, and steering mechanism, the power unit was a 1,897cc overhead-camshaft four - the first such engine ever to feature in a Mercedes-Benz. Breathing through twin Solex downdraft carburetors, the M121 unit produced 105bhp DIN (120bhp SAE) at 5,700rpm, an output sufficient to propel the 190 SL to 100km/h (62mph) in 14.5 seconds and on to a top speed of 171km/h (106mph). The new model thus combined 100mph-plus performance with economical fuel consumption in the region of 25-30 miles per gallon.

This beautiful 190 SL comes complete with its original plastic wallet containing the original owner's manual, service booklet, and parts catalogue. The service booklet states that the Mercedes was supplied via Black & White Garages (Harvington) Ltd; its first owner was a Mr Billington of Stratford-on-Avon, and the car was first registered '115 FWP'. There are numerous stamps in the booklet, and it is noted that the speedometer was changed in 1960 when the car had covered 30,000 miles. Carried out by Bournemouth Majestic Garage, the last regular service is dated 1971 (at 13,500 miles) while the final stamp (by Auto-Care, Poole, Dorset) is dated 2014 at 57,900 miles (87,900 actual miles).

It is understood that '115 FWP' was used up to 1978 when the owner became ill, and following their death in the early 1990s was inherited by their stepson. The latter subsequently despatched the car to Terry Van Der Zee (TT Racing Motors) in Blandford Forum, Dorset for a full no-expense-spared restoration, which was undertaken during 2006/2007 (bills on file). The Mercedes then went back into storage before being purchased in 2011 by the immediately preceding owner. The latter then had the car bare-metal re-sprayed and the interior re-trimmed in red leather. The current vendor purchased '115 FWP' in October 2014.

Described by its owner as in excellent condition, this exceptional Mercedes-Benz 190 SL is offered with a V5C Registration Certificate, MoT to October 2018, copy parts list, and a history file containing the aforementioned documentation and restoration invoices.

£100,000 - 120,000
€110,000 - 140,000

383

The property of Engelbert Humperdinck

1964 BENTLEY SERIES 3 CONTINENTAL TWO-DOOR SALOON

Coachwork by Park Ward Ltd

Registration no. EGC 359B

Chassis no. BC38XC

- Built to the order of R G McLeod
- Unique owner-specified design
- One of the last truly coachbuilt Bentleys
- Present ownership since 1979
- Professionally restored in 2011/2012



'A long-time Bentley customer, Australian-born R G McLeod had set a pattern of ordering shortened cars, with the normal wheelbase but a wheel more or less at each corner and coachwork with minimum overhang supplied to his design by H J Mulliner.' – Martin Bennett, *'Bentley Continental'*.

Offered here is one of R G McLeod's shortened Bentley Continentals, 'BC38XC', which is featured on pages 136 and 137 of Martin Bennett's book.

Described by *The Autocar* as, 'A new stage in the evolution of the post-war Bentley', the magnificent Continental sports saloon has been synonymous with effortless high speed cruising in the grand manner since its introduction on the R-Type chassis in 1952. With the arrival of the final (S-Type) generation of six-cylinder cars in 1955, the Continental lost a little of its individuality but none of its exclusivity, and this trend continued after the arrival of the V8-engined S2.

Introduced in the autumn of 1959, the Rolls-Royce Silver Cloud II and Bentley S2 appeared externally unchanged from their Silver Cloud and S-Type predecessors, though their performance was considerably enhanced by the new 6,230cc aluminium-alloy V8 engine.

Power-assisted steering was now standard and there was no longer the option of a manual gearbox, Rolls-Royce's own four-speed automatic transmission being the sole offering. The S2 Continental chassis differed from the standard version by virtue of its four-leading-shoe front brakes, shorter radiator and, up to chassis number 'BC99BY', higher gearing.

The Bentley Continental was, of course, exclusively a coachbuilt automobile. The firms of H J Mulliner, Park Ward, and James Young all offered bodies on the Continental S2 (and later S3) chassis. By far the most striking of the S2 Continentals were those bodied by Rolls-Royce's in-house coachbuilder Park Ward, and this design by Norwegian Vilhelm Koren, with its influential continuous front-to-rear wing line, would continue on the Continental S3. Quad headlamps were the S3's major styling innovation, and on the Continental - now bodied by the merged firm of H J Mulliner, Park Ward - were contained in slanting nacelles, giving rise to this model's 'Chinese Eye' sobriquet. These 'Chinese Eye' models constituted the majority of coachbuilt Rolls-Royce and Bentley variants completed between 1962 and 1966. Headlamps aside, the most significant change was to the S3's engine, which boasted an increased compression ratio and larger carburetors, modifications that raised peak power by some 7%.



Its chassis card (copy on file) described this unique car's body style as 'Continental 2dr saloon with special modified body to drawing no. 2035/F'. As well as its shortened chassis, 'BC38XC' was ordered with electric windows, manual window winder, special rear bumper, glass sunroof, batteries fitted in centre of boot, and sliding front seats with Reutter reclining mechanisms. The dummy second exhaust tailpipe is another signature feature of a McLeod Continental, having appeared on previous examples belonging to him. The full-length sunroof, re-trimmed interior, and repainted body are obvious changes made since the Continental left the factory.

This unique Bentley Continental is offered for sale today by the world famous recording artist and entertainer, Engelbert Humperdinck, who acquired the car in May 1979 from one Southan Morris (see old V5 document on file). Born Arnold George Dorsey in 1936, he began performing in the early 1950s under the name 'Gerry Dorsey' but did not get his big break until his manager suggested he change his name to the more memorable Engelbert Humperdinck, after the 19th Century German composer.

The change paid off in 1967 when his version of 'Release Me' topped the UK charts. He followed up that success with 'There Goes My Everything' and 'The Last Waltz', and has remained a fixture of the global pop charts ever since. Now well into his sixth decade as a successful entertainer, Engelbert represented the United Kingdom in the 2012 Eurovision Song Contest with 'Love Will Set You Free'. He continues to record and perform.

A considerable sum of money has been spent on restoring the Bentley in recent years. Undertaken in 2011 by marque specialists Colbrook of Stilton, Peterborough, these works included a major overhaul of the braking system, fitting two new fuel pumps, overhauling the carburettors, fitting a complete new exhaust system, and countless other more minor repairs. That same year the interior and boot were fully re-trimmed by Swann Systems of Beaumont Leys, Leicester, while in 2012 the hubcaps and front bumper were re-chromed. Detailed bills are on file (inspection recommended) and the car also comes with a current V5C registration document. A wonderful opportunity to acquire one of the more unusual variations on the Bentley Continental theme.

£80,000 - 90,000
€91,000 - 100,000

384

1995 PORSCHE 911 TYPE 993 CARRERA CUP COMPETITION COUPÉ

Chassis no. WP0ZZZ99ZTS398078

- *Rare limited-edition competition model*
- *Left-hand drive*
- *Built to German-market specification*
- *FFSA Technical Passport*



The exciting car offered here is an example of one of the rarest of Porsche 911 Type 993 variants: the Carrera RS Cup with the 3.8-litre engine, which was intended for amateur motor sports use and produced in limited numbers.

In 1993 Porsche had introduced what is regarded by many as the most beautiful 911 of all: the Type 993. Over the years the 911 had received numerous aerodynamic and safety-inspired add-ons, diluting the purity of the original form; the Type 993's arrival marked a return to basic principles, being recognisably a 911 but one in which all functions had been harmoniously integrated in a truly outstanding example of modern automotive styling. The range offered remained pretty much as before, comprising two- and four-wheel drive models, the legendary Turbo and the Cabriolet convertible, all powered by the latest 3.6-litre version of Porsche's perennial flat-six engine.

In January 1995 the range was extended by the introduction of the Carrera RS. Described by its maker as a 'street-legal two-seater', the RS was based on the two-wheel drive Carrera and like its legendary RennSport forebear of the 1970s, was considerably lighter and more powerful than the stock version. Everything considered unnecessary for competition purposes - electric windows, electric mirrors, central locking, headlight washers, stereo speakers, etc - was discarded, while aluminium was used for the front luggage compartment lid, and thinner window glass specified. Airbags were optional and the two bucket seats were lighter than the standard items; the result was a reduction in weight of around 220lb (100kg). Power assisted steering was retained.

For the Carrera RS '3.8', the engine's bore size was increased by 2mm for a capacity of 3,746cc; maximum power went up to 300bhp, lowered suspension improved the handling, and the RS came as standard with the optional dynamic limited-slip differential and RS Cup-type 18" wheels. There was also a more 'hardcore', though still road-legal, Clubsport version, 100 of which were built to meet the FIA GT2 homologation requirements, and the track-only Carrera Cup. The latter was intended for the Porsche Pirelli Supercup (later the Porsche Michelin Supercup) that had run as a support series for Formula 1 since 1993.



Enthusiasts worldwide have been thrilled by the sight of packed fields of identical cars driven - mainly - by rising stars, engaged in some of the closest-fought racing to be found anywhere. Now known as the Porsche Mobil 1 Supercup, the series visits legendary European venues such as Monaco, Monza, and Spa, with races held immediately after the Sunday morning F1 warm-up session as a prelude to the main event.

For the Porsche Pirelli Supercup, 1996 was a bumper year with a larger field (of up to 34 cars) on the starting grid than ever before. In its fourth season, the fastest one-make series in the world offered passionate Porsche customers and Grand Prix spectators alike what they most adored: fierce duels between classic GT cars. That same year, the German Porsche Carrera Cup entered its seventh season in style, offering equally hard-fought competition. Both series featured the stunning Carrera Cup 3.8, with a claimed 315bhp on tap, weighing only 1,100kg, and a top speed of around 270km/h (170mph). Drivers entering these Cup competitions included Ralf Schumacher, Norberto Fontana, Bernard Simmenauer, Jacques Laffite, Stefan Johansen, Ralf Waldmann, Harald Grohs, Kevin Schwantz, Ralf Kelleners, Jurgen von Gartzten, Jack Leconte, Patrick Huisman, Paul Belmondo, Patrick Simon, and Emmanuel Collard.

Representing a rare opportunity to acquire one of these special Type 993 Cup cars, this example is finished in classic Grand Prix White and comes equipped with the six-speed manual gearbox, unassisted steering, 18" centre-locking magnesium-alloy wheels, locking differential, 75-litre fuel tank, roll cage, single Sparco seat, and biplane rear wing. The car is offered with FFSA Technical Passport (issued 1997), dynamometer printout (300 horsepower), and a copy of the factory specification sheet.

These Cup cars are ideal for anyone considering taking up historic racing, and represent excellent value for money when compared to the likes of the RSR and GT2 models. An opportunity not to be missed.

£180,000 - 220,000
€210,000 - 250,000

385

From the private collection of Patrick Gosling

1997 FERRARI 550 MARANELLO COUPÉ

Registration no. M55 ORH

Chassis no. ZFFZR49C000108106

- Delivered new in the UK
- Right-hand drive
- Circa 46,500 miles recorded
- Service history and all original books/tools



'The Maranello needs no excuses: it is right-minded, a return to traditional values, albeit values and standards that tower high above those set by the Daytona when it shuffled off to extinction a quarter of a century ago.' – *Car magazine*.

With the introduction of the 550 Maranello in 1997, Ferrari returned to its tradition of building front-engined V12 sports cars, resurrecting a line that had remained dormant since the demise of the 365 GTB/4 'Daytona' in 1974. The heart of any Ferrari is its engine, and the 550 Maranello's 48-valve, 5.5-litre V12 developed 485bhp at 7,000rpm, some 100-or-so horsepower more than the Daytona's. Ferrari had discovered long ago that providing optimum balance in a front-engined sports car necessitated the use of a rear transaxle, and the Maranello's came with six speeds. The power train was housed in a tubular steel chassis, to which was attached aluminium coachwork, while the all-independent suspension incorporated dual-mode (normal/sports) damping, switch-selectable by the driver, which was complemented by speed-sensitive power-assisted steering.



Styled by Pininfarina like its illustrious 'Daytona' predecessor, the 550 Maranello was similarly proportioned, adopting the classical combination of long bonnet, small cabin and truncated tail. The body's aerodynamics were developed in the wind tunnel, where hours of testing ensured that the minimum of drag was combined with constant downforce regardless of set up, an important consideration in a 200mph road car. Styling details such as the bonnet air scoop and hot air outlets behind the front wheelarches recalled the great competizione Ferraris of the past, in particular the immortal 250 GTO, while the tail incorporated Ferrari's characteristic twin circular lights.

First registered on 17th April 1997, this particular Ferrari 550 Maranello is offered from the private collection of renowned automotive photographer Patrick Gosling, who worked closely with Scuderia Ferrari in the early 2000s. The car was purchased by Patrick after experiencing some thrilling 'Hot Laps' being driven by both Michael Schumacher and Rubens Barrichello in a similar 550 Maranello around Ferrari's Fiorano test track.

Finished in Grigio Titanium with Bordeaux leather interior, 'M55 ORH' features the optional Lusso quilted rear parcel shelf, two Tracker systems, and a Tubi exhaust. Patrick has owned the car since November 2014 (it was registered to a friend in 2014 and he took over registration in November 2015). It has been cared for by Autofficina, serviced and MoT'd annually while benefiting from various running improvements: door hinges, headlamp rubbers, recently re-trimmed dashboard, etc. The car was featured in the Ferrari Owners Club magazine in June 2017. Professionally stored by Bespoke Handling in Sussex for the past couple of years, it will have been serviced and MoT'd immediately prior to the sale.

The Ferrari comes with comprehensive service records and receipts from Grimaldi, KHPC, Neil Lucas and a few others. Also included in the sale is the original tool kit in its leather case; all original books in their leather wallet; and both key fobs: red and black.

£90,000 - 120,000
€100,000 - 140,000

386

1955 JAGUAR XK140 DROPHEAD COUPÉ

Registration no. 2532 FS

Chassis no. S807077DN

- One of 479 right-hand drive drophead coupés
- Overdrive transmission
- Restored in 1995
- Recently re-commissioned by Twyford Moors
- Hood newly re-trimmed by Mike Thomas





Launched in 1954, the Jaguar XK140 was broadly similar to, though more refined than, its sensational XK120 predecessor, major engineering changes being confined to the repositioning of the engine 3" further forward and the adoption of rack-and-pinion steering as used on the racing C-Type. The suspension and brakes remained much as before, though with stiffer torsion bars at the front and telescopic shock absorbers replacing the previous lever type at the rear. Like its forbear, the XK140 was built in three model types: roadster, coupé and drophead coupé, the latter two offering usefully increased cabin space and occasional rear seats. Outwardly the newcomer was distinguishable by its revised radiator grille, rear lights incorporating flashing indicators, and larger bumpers - the latter adopted to withstand the cut and thrust of urban parking.

The power unit remained Jaguar's well-tryed, 3.4-litre, twin-cam six, which now produced 190bhp in standard trim thanks to higher-lift camshafts and revised porting. To ensure reliability, steel bearing caps replaced the previous cast-iron type. A close-ratio gearbox enabled better use to be made of the increased performance while Laycock-de Normanville overdrive became an option for the first time. Special Equipment (SE) XK140s came with wire wheels and Lucas fog lamps, and could be ordered with an engine developing 210bhp courtesy of the 'C'-type cylinder head. XK140 performance was well up to the standards set by its exemplary predecessor, contemporary magazine road-tests regularly recording top speed figures in excess of 120mph.

Only 479 XK140 drophead coupés were made in right-hand drive configuration (there were 2,310 with left-hand drive) making this example one of the rarest of home-market XKs. A desirable overdrive-equipped model, this car was completed in April 1955 and despatched to Rossleigh in Edinburgh; it was supplied by John Brown and Co to a Mr B B Henshaw, the first owner.

This car's subsequent early history is not known, but it is recorded as having been purchased by a James Kirkpatrick Robinson in 1979. In 1995, the Jaguar was restored by Lance McCormack (The Romance of Rust) of Ealing, West London, following which it was kept in a private collection in Dublin for some 20 years before returning to the UK in 2017. Renowned XK specialists Twyford Moors have recently carried out extensive re-commissioning works and have checked the car thoroughly. These works included fitting new chrome wheels, radial tyres, hubs, brake drums and other items. The quality of the hood and its fit are vital considerations when restoring any drophead, and the making of this car's new bespoke hood and all its ancillaries was undertaken by Mike Thomas's leading XK trimming workshop.

'2352 FS' is now resplendent in blue with red leather interior, and represents a wonderful opportunity to acquire a rare, totally correct, and matching numbers right-hand drive XK140 drophead coupé. There are tax discs on file showing continued use from 2005 to date, and the car also comes with a current MoT and a UK V5C registration document.

£120,000 - 140,000
€140,000 - 160,000

387

1959 ALFA ROMEO 2000 SPIDER

Coachwork by Carrozzeria Touring

Registration no. VVS 334

Chassis no. AR102 0401637

- Imported from the USA
- Left-hand drive
- Restored in the early 1990s
- Used sparingly since restoration
- Concours award-winning



Replacement for the 1900 line, the 102 Series '2000' cars first appeared in 1958, a Bertone-bodied Sprint coupé followed in 1960. Nowadays referred to as the 'old' 2-litre, the twin-cam 2000 engine combined elements of the superseded 1900 and new Giulietta, retaining the former's cast-iron block and separate cam covers but featuring the latter's bucket-and-shim method of valve adjustment. Spider and Sprint versions came with 115bhp on tap, good enough for a top speed in excess of 110mph. Beneath the skin the 2000 remained much as the last of the 1900s, with independent front suspension, live rear axle, five-speed gearbox, and drum brakes all round. Touring's renowned Superleggera (Superlight) method of body construction was employed.

Despite a relaxed high-speed cruising ability and excellent smoothness, the 2000 in its day tended to be overshadowed by the smaller and cheaper Giulietta, and only now is the model beginning to receive the attention it deserves.



Few Alfa Romeo 2000 Spiders came to the UK as new cars, this left-hand drive example was originally exported to the USA and is one of the few in this country. Imported circa 1990 from the USA by its former owner, the late Robert Gharibi, this Touring Spider was restored by him and his friend and business partner, Harry Abrahamian. Both Robert and Harry were knowledgeable Alfa Romeo enthusiasts, Robert already having restored two classic Alfas to concours-winning condition prior to this 2000. The restoration was carried out in his home garage, which was well equipped with Alfa tools, while all parts used were purchased through Alfa Romeo dealers or Alfa parts specialists both in Europe and the USA.

This extensive restoration culminated in a class win (against strong opposition) at the National Alfa Day in 1993 and runner-up place (by a single point) in the Master Class category the following year. The immediately preceding owner, Mr Lodovico Crescenzi, purchased 'VVS 334' in October 1994 and kept the car in garage storage for the next six years without ever driving it.

In June 2000, the Alfa Romeo was offered for sale at Bonhams' Goodwood Festival of Speed Sale (Lot 916) where it was purchased by the current vendor. After six years off the road, the car had been re-commissioned prior to sale by marque specialists Thorobred Cars of Laleham, Surrey.

Since buying the Spider, the owner has won prizes at the *Auto Italia* Festival Concours and the Alfa Romeo Owners' Club Annual concours. Regarded as one of the finest examples of its type anywhere, 'VVS 334' has previously been invited to be displayed on the Alfa Romeo Owners' Club stand at the International Classic Motor Show. It has also been featured in *Auto Italia* magazine, described as a 'superb concours winning 2000 Spider'.

For the last 18 years, the car has been used sparingly and always dry stored. It has been regularly serviced and MoT'd, as evidenced by bills on file from marque specialists Andrew Thorogood Restorations together with numerous expired MoT certificates confirming its limited use. The most recently service was carried out in May 2017 at a cost of £1274, and the car is MoT'd to 18th May 2019. A wonderful opportunity to acquire one of these under-appreciated Italian thoroughbreds restored to concours-winning condition.

£65,000 - 75,000
€74,000 - 86,000

388

1965 MORRIS MINI COOPER 970 'S' SPORTS SALOON

Registration no. CBK 99C
Chassis no. K-A2S4-550919

- One of only 482 produced
- Rare survivor in original specification
- Original 970cc engine
- Restored by the previous owner





'To its credit, the 970 S remained competitive in racing for many years, although after the end of the homologation period many 970 S Coopers were converted to different A-series engines, making the original 970cc car a genuine rarity today.' – Chris Rees, *'Complete Classic Mini'*.

Considered by automobile historians to be one of the most important and influential designs ever, the Austin/Morris Mini was in production for 40 years and today remains the most enduring icon of the British motor industry.

To many though - its designer Alec Issigonis included - the notion that the Mini might have a future as anything other than basic transport was anathema, and the idea of a high-performance version was laughable. One man though, saw it quite differently. Racing car manufacturer John Cooper already knew quite a bit about tuning BMC's A-Series engine - he was running the company's Formula Junior effort at the time - and a test drive in a prototype Mini convinced him of the car's competition potential. The result, launched in September 1961, was the Mini Cooper, a car that offered a size/price/performance package that was nothing short of miraculous. The Mini Cooper soon established its credentials as a rally and race winner, and the stage was set for even faster versions.

Ringed the changes on combinations of bore and stroke, BMC ended up making the Mini Cooper in no fewer than five different engine capacities, some of which were chosen solely for the purpose of homologation for competitions. One of the latter was the short-stroke 970cc 'S' unit, which was only available to special order. Once the 1,000-or-so required for homologation had been completed, the model was quietly dropped.

This original Morris Cooper S (one of only 482 produced with the 970cc engine) was restored - both mechanically and cosmetically - to an apparently excellent standard by the immediately preceding, and obviously most fastidious, owner. The current owner acquired the car in March 2017. 'CBK 99C' retains its original 970cc engine, complete with AEG151 cylinder block and 12G190 gearbox, while the interior likewise is original apart from the steering wheel. Boasting style and performance in abundance, and described by the vendor as in generally very good condition, this rarest of Cooper 'S' variants is offered with a V5C registration document.

£50,000 - 60,000
£57,000 - 68,000

END OF SALE

FRIDAY AUGUST 24
Carmel, California

INQUIRIES
+1 212 461 6515, East Coast
+1 415 391 4000, West Coast
motors.us@bonhams.com

QUAIL LODGE AUCTION



100pt FCA Platinum Award Winning Equipped with period competition features Matching numbers and original coachwork

1962 FERRARI 250 GT SWB BERLINETTA

Design by Pinin Farina - Coachwork by Scaglietti
Ferrari Classiche Certified



*Unique one-off design
Winner 'Le Grand Prix du Salon' Paris 1950
Matching-numbers and exceptional restoration*
1948 TALBOT-LAGO T26 RECORD SPORT COUPE DE VILLE
Coachwork by Saoutchik



*Exceptional Restoration
Matching numbers and Original Coachwork*
1949 ALFA ROMEO 6C 2500 SUPER SPORT CABRIOLET
Coachwork by Pinin Farina



*One of just 37 examples made
Pebble Beach and Villa d'Este Concours Entrant
Exquisite restoration by Nino Epifani*
1953 SIATA 208S SPIDER
Coachwork by Motto



*Superb, award-winning restoration
The last known example built*
1955 SWALLOW DORETTI



*In same ownership for nearly 5 decades
Concours restoration to factory specifications*
1911 MERCEDES 28/60 HP TOURING



*Exquisite condition
Matching numbers and original coachwork*
1973 FERRARI 365 GTB/4 DAYTONA
Design by Pininfarina - Coachwork by Scaglietti
Ferrari Classiche Certified

Bonhams

International Auctioneers and Appraisers – bonhams.com/quail

© 2018 Bonhams & Butterfields Auctioneers Corp. All rights reserved. Bond No. 57BSBGL0808

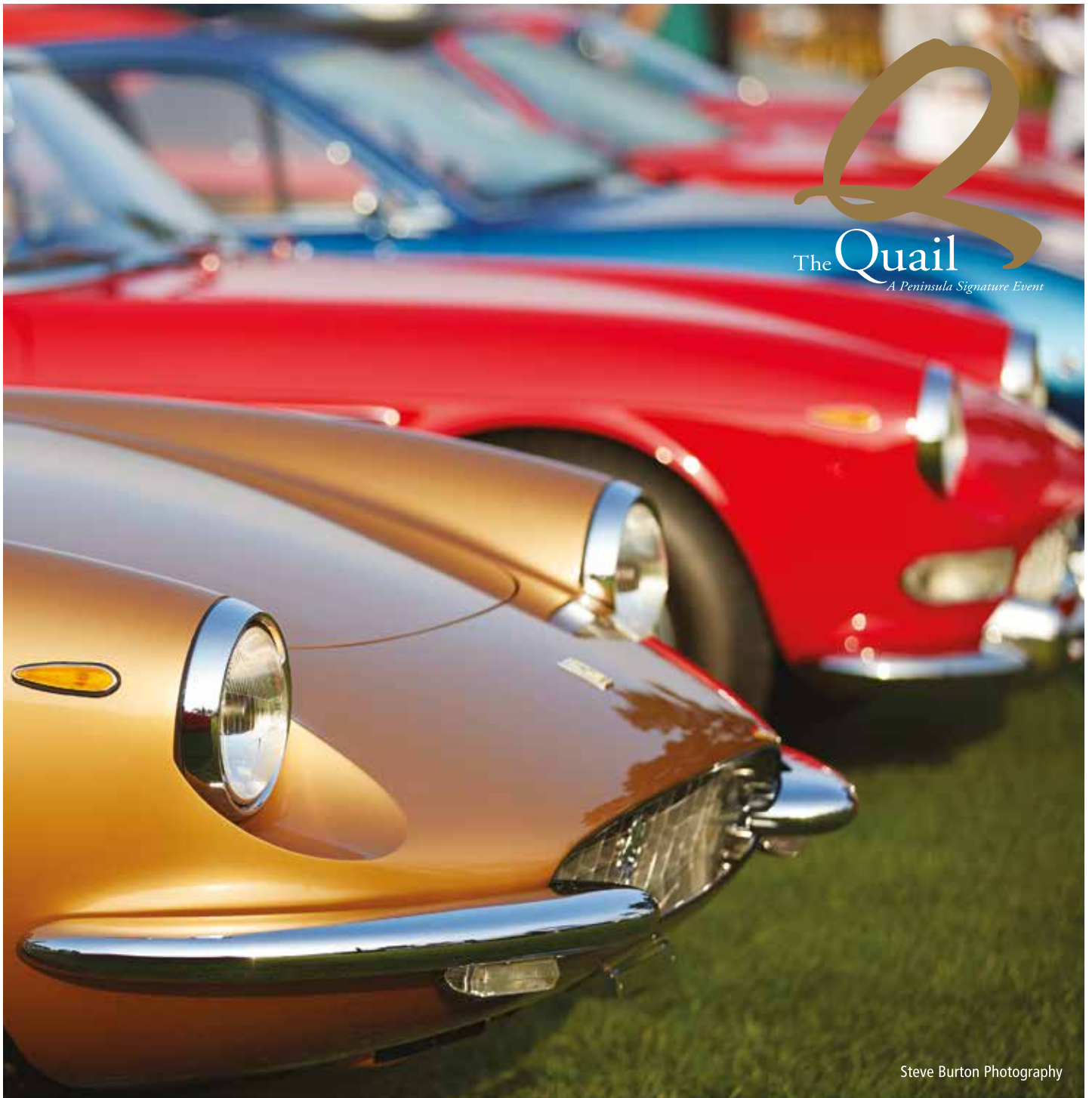

The Quail
A Peninsula Signature Event

Steve Burton Photography

CALLING ALL CARS!

The Quail, A Motorsports Gathering • Friday, August 24, 2018 • 10:00am to 4:00pm • Hosted at Quail Lodge & Golf Club in Carmel, California

The 16th Annual *The Quail, A Motorsports Gathering* invites you to participate in one of the world's most exclusive concours held during Monterey Car Week by entering a vehicle from your private collection! *The Quail's* Featured Classes for 2018 are: 70 Years of the Iconic Porsche 356 and The Alois Ruf Reunion. *The Quail's* Traditional Classes include: Pre-War Sports and Racing, Post-War Racing, Post-War Sports 1945-1960, Post-War Sports 1961-1975, The Great Ferraris, Supercars, Custom Coachwork, and Sports and Racing Motorcycles.

To enter a vehicle from your private collection, obtain an application by visiting signatureevents.peninsula.com or by calling +1 (831) 620-8879.

FOLLOW US! Facebook.com/PSE.TheQuailEvents • Twitter.com/TheQuailEvents
Instagram.com/TheQuailEvents • YouTube.com/QuailSignatureEvents

THE PENINSULA
SIGNATURE EVENTS

**ENTERTAINMENT
MEMORABILIA**

Wednesday 18 July 2018
Knightsbridge, London

**LE MANS: THE ORIGINAL POSTER
ARTWORK BY TOM JUNG**

Cinema Center Films /
National General Pictures, 1971,
gouache and pencil on board, starring
Steve McQueen as 'Michael Delaney'
This important and rare artwork was used
for the U.S and British poster campaigns.
£8,000 - 12,000 (€9,200 - 13,700) *

ENQUIRIES

+44 (0) 20 7393 3984
entertainment@bonhams.com



Bonhams

MONTPELIER STREET • KNIGHTSBRIDGE

bonhams.com/entertainment

* plus buyer's premium and other fees. For details of the charges payable in addition to the final hammer price, please visit bonhams.com/buyersguide

GOODWOOD REVIVAL SALE

Important Collectors'
Motor Cars and Automobilia
Saturday 8 September 2018
Chichester, Sussex

ENTRIES NOW INVITED



Current family ownership since 1965, freshly restored by David Davenport
1937 JAGUAR SS100 3½-LITRE ROADSTER

Formerly the property of Sir Henry Segrave
1926 SUNBEAM 3.0-LITRE SUPER SPORTS 'TWIN CAM' TOURER

The Goodwood Revival Meeting is the world's most prestigious historic motor racing event and, as a founding sponsor, Bonhams is privileged to present another exceptional sale of Sports, Competition and Touring motor cars.

To consign your motor car into this landmark sale, please contact the department.

In current ownership since 1972

1964 FERRARI 250 GT LUSSO BERLINETTA

ENQUIRIES

Motor cars

+44 (0) 20 7468 5801
ukcars@bonhams.com

Automobilia

+44 (0) 8700 273 619
automobilia@bonhams.com

Catalogue

+44 (0) 1666 502 200
subscriptions@bonhams.com



Bonhams

[bonhams.com/motorcars](https://www.bonhams.com/motorcars)

THE BEAULIEU SALE
Collectors' Motor Cars,
Motorcycles and Automobilia

Saturday 1 September 2018
The National Motor Museum
Beaulieu, Hampshire

ENTRIES NOW INVITED

The ex-National Motor Museum,
1903 PANHARD ET LEVASSOR
7HP TWIN-CYLINDER FOUR-SEAT
REAR-ENTRANCE TONNEAU

ENQUIRIES

Motor Cars
+44 (0) 20 7468 5801
ukcars@bonhams.com

Motorcycles

+44 (0) 20 8963 2817
motorcycles@bonhams.com



Bonhams

bonhams.com/motorcars

THE BEAULIEU SALE
Collectors' Motor Cars,
Motorcycles and Automobilia

Saturday 1 September 2018
The National Motor Museum
Beaulieu, Hampshire

ROY NOCKOLDS (BRITISH, 1911-1979),
'Bugatti Type 57S 'Corsica',
£1,500 - 2,500 *

To be offered at the Beaulieu Sale as part of
the Stanley Sears and Jack Sears Collection

ENQUIRIES
+44 (0) 8700 273 619
automobilia@bonhams.com

ENTRIES NOW INVITED



Bonhams

bonhams.com/automobilia

* For details of the charges payable in addition to the final hammer price, please visit bonhams.com/buyersguide

COLLECTOR MOTORCARS AND AUTOMOBILIA AUCTION AT THE SIMEONE FOUNDATION AUTOMOTIVE MUSEUM

Monday October 8, 2018
Philadelphia, PA

Consignments now invited

Bonhams annual auction at the Simeone Foundation Automotive Museum is held during the week immediately preceding the Antique Automobile Club of America Fall Meet each October.

INQUIRIES
East Coast
+1 (212) 461 6514

West Coast
+1 (415) 391 4000

sfam.auction@bonhams.com



Ex Ford Museum, matching numbers
1913 ROLLS-ROYCE LONDON TO EDINBURGH SILVER GHOST
Coachwork by Reuters
Sold at Simeone 2017 for \$1,001,000



From the Estate of David L. Van Schaick
1929 BENTLEY 4.5 LITER 'LE MANS REPLICA' FABRIC TOURER
Coachwork in the style of Vanden Plas
Sold at Simeone 2017 for \$585,500



1963 CHEVROLET CORVETTE 327/360HP ROADSTER
Sold at Simeone 2017 for \$82,500

Bonhams

bonhams.com/motorcars

© 2018 Bonhams & Butterfields Auctioneers Corp. All rights reserved. Bond No. 57BSBGL0808

INTERNATIONAL AUCTION CALENDAR 2018

FINE AND RARE WINES

Thursday 12 July	London
Friday 14 September	San Francisco
Thursday 27 September	London
Friday 16 November	Hong Kong
Thursday 29 November	London
Friday 7 December	San Francisco

WHISKY

Friday 17 August	Hong Kong
Wednesday 3 October	Edinburgh
Wednesday 12 December	Edinburgh

ENQUIRIES

UK

+44 (0) 20 7468 5811
wine@bonhams.com
whisky@bonhams.com

USA

+1 (415) 503 3363
wine.us@bonhams.com

HONG KONG

+852 2918 4321
winehk@bonhams.com

Bonhams

**COMPLIMENTARY
AUCTION APPRAISAL**

Visit bonhams.com/motorcycles
to submit a complimentary
auction appraisal request.

A CHANCE TO WIN

Visit bonhams.com/lovebikes
to register for a chance to
win a 12 month worldwide
motorcycle catalog
subscription.

COLLECTORS' MOTORCYCLES AT THE BARBER MUSEUM

Birmingham, Alabama
Saturday October 6, 2018

INQUIRIES

West Coast

Craig Mallery
+1 (323) 436 5470
craig.mallery@bonhams.com

Andrew Barrett
+1 (323) 436 5450
andrew.barrett@bonhams.com

CATALOG

+44 (0) 1666 502 200
subscriptions@bonhams.com

CONSIGNMENTS INVITED



2nd example built, history from new
1949 VINCENT 998CC BLACK LIGHTNING
\$400,000 - 500,000 *

Bonhams

bonhams.com/barber

* For details of the charges payable in addition to the final hammer price, please visit bonhams.com/buyersguide

THE AUTUMN STAFFORD SALE

The 25th Carole Nash
Classic Motorcycle Mechanics Show
Saturday 13 & Sunday 14 October 2018

ENTRIES INVITED

COMPLIMENTARY AUCTION APPRAISAL

To discuss any aspect of selling or buying collectors motorcycles at auction, please contact the London office or visit bonhams.com/motorcycles to submit a complimentary auction appraisal request.

1911 PIERCE 688CC FOUR
Sold October 2017, £107,900

ENQUIRIES

Motorcycles (London)
+44 (0) 20 8963 2817
ukmotorcycles@bonhams.com

Catalogue

+44 (0) 1666 502 200
subscriptions@bonhams.com



Bonhams

bonhams.com/autumnstafford

Prices shown include buyer's premium. Details can be found at bonhams.com

**MODERN SPORTING
GUNS, RIFLES AND
VINTAGE FIREARMS**

Thursday 29 November 2018
Knightsbridge, London

**A PAIR OF KELL-ENGRAVED 12-BORE
SELF-OPENING SIDELOCK EJECTOR GUNS
BY J. PURDEY & SONS, NO. 24318/9**

Sold for £39,000

ENQUIRIES

+44 (0) 20 7393 3815

patrick.hawes@bonhams.com



Bonhams

Polygon

Polygon Transport was founded in 1984 and is one of the longest established Collectors' Motor Car and Motorcycle carriers in the UK



> Polygon is the carrier of choice for The National Motor Museum, Beaulieu, The Louwman Museum in The Netherlands, Goodwood and Bonhams Auctioneers, where they are in attendance at each auction to provide assistance.

Polygon has a fleet of vehicles to handle a single motorcycle or car, to an entire collection, including spares and memorabilia. Polygon can also arrange national or international transport and shipping, including export paperwork and licences.

> **Polygon Transport**
Unit 2H, Marchwood Industrial Park
Normandy Way
Marchwood
Southampton
SO40 4BL

Tel +44 (0)2380 871555
Fax +44 (0)2380 862111
Email polygon@polygon-transport.com
Web www.polygon-transport.com

Valued Polygon clients



NOTICE TO BIDDERS

This notice is addressed by *Bonhams* to any person who may be interested in a *Lot*, including *Bidders* and potential *Bidders* (including any eventual *Buyer* of the *Lot*). For ease of reference we refer to such persons as "*Bidders*" or "you". Our List of Definitions and Glossary is incorporated into this *Notice to Bidders*. It is at Appendix 3 at the back of the *Catalogue*. Where words and phrases are used in this notice which are in the List of Definitions, they are printed in italics.

IMPORTANT: Additional information applicable to the *Sale* may be set out in the *Catalogue* for the *Sale*, in an insert in the *Catalogue* and/or in a notice displayed at the *Sale* venue and you should read them as well. Announcements affecting the *Sale* may also be given out orally before and during the *Sale* without prior written notice. You should be alert to the possibility of changes and ask in advance of bidding if there have been any.

1. OUR ROLE

In its role as *Auctioneer* of *Lots*, *Bonhams* acts solely for and in the interests of the *Seller*. *Bonhams'* job is to sell the *Lot* at the highest price obtainable at the *Sale* to a *Bidder*. *Bonhams* does not act for *Buyers* or *Bidders* in this role and does not give advice to *Buyers* or *Bidders*. When it or its staff make statements about a *Lot* or, if *Bonhams* provides a *Condition Report* on a *Lot* it is doing that on behalf of the *Seller* of the *Lot*. *Bidders* and *Buyers* who are themselves not expert in the *Lots* are strongly advised to seek and obtain independent advice on the *Lots* and their value before bidding for them. The *Seller* has authorised *Bonhams* to sell the *Lot* as its agent on its behalf and, save where we expressly make it clear to the contrary, *Bonhams* acts only as agent for the *Seller*. Any statement or representation we make in respect of a *Lot* is made on the *Seller's* behalf and, unless *Bonhams* sells a *Lot* as principal, not on our behalf and any *Contract for Sale* is between the *Buyer* and the *Seller* and not with us. If *Bonhams* sells a *Lot* as principal this will either be stated in the *Catalogue* or an announcement to that effect will be made by the *Auctioneer*, or it will be stated in a notice at the *Sale* or an insert in the *Catalogue*.

Bonhams does not owe or undertake or agree to any duty or responsibility to you in contract or tort (whether direct, collateral, express, implied or otherwise). If you successfully bid for a *Lot* and buy it, at that stage *Bonhams* does enter into an agreement with the *Buyer*. The terms of that contract are set out in our *Buyer's Agreement*, which you will find at Appendix 2 at the back of the *Catalogue*. This will govern *Bonhams'* relationship with the *Buyer*.

2. LOTS

Subject to the *Contractual Description* printed in bold letters in the *Entry* about the *Lot* in the *Catalogue* (see paragraph 3 below), *Lots* are sold to the *Buyer* on an "as is" basis, with all faults and imperfections. Illustrations and photographs contained in the *Catalogue* (other than photographs forming part of the *Contractual Description*) or elsewhere of any *Lots* are for identification purposes only. They may not reveal the true condition of the *Lot*. A photograph or illustration may not reflect an accurate reproduction of the colour(s) of the *Lot*. *Lots* are available for inspection prior to the *Sale* and it is for you to satisfy yourself as to each and every aspect of a *Lot*, including its authorship, attribution, condition, provenance, history, background, authenticity, style, period, age, suitability, quality, roadworthiness (if relevant), origin, value and estimated selling price (including the *Hammer Price*). It is your responsibility to examine any *Lot* in which you are interested. It should be remembered that the actual condition of a *Lot* may not be as good as that indicated by its outward appearance. In particular, parts may have been replaced or renewed and *Lots* may not be authentic or of satisfactory quality; the inside of a *Lot* may not be visible and may not be original or may be damaged, as for example where it is covered by upholstery or material. Given the age of many *Lots* they may have been damaged and/or repaired and you should not assume that a *Lot* is in good condition. Electronic or mechanical parts may not operate or may not comply with current statutory requirements. You should not assume that electrical items designed to operate on mains electricity will be suitable for connection to the mains electricity supply and you should obtain a report from a qualified electrician on their status before

doing so. Such items which are unsuitable for connection are sold as items of interest for display purposes only. If you yourself do not have expertise regarding a *Lot*, you should consult someone who does to advise you. We can assist in arranging facilities for you to carry out or have carried out more detailed inspections and tests. Please ask our staff for details.

Any person who damages a *Lot* will be held liable for the loss caused.

3. DESCRIPTIONS OF LOTS AND ESTIMATES

Contractual Description of a Lot

The *Catalogue* contains an *Entry* about each *Lot*. Each *Lot* is sold by its respective *Seller* to the *Buyer* of the *Lot* as corresponding only with that part of the *Entry* which is printed in bold letters and (except for the colour, which may be inaccurately reproduced) with any photograph of the *Lot* in the *Catalogue*. The remainder of the *Entry*, which is not printed in bold letters, represents *Bonhams'* opinion (given on behalf of the *Seller*) about the *Lot* only and is not part of the *Contractual Description* in accordance with which the *Lot* is sold by the *Seller*.

Estimates

In most cases, an *Estimate* is printed beside the *Entry*. *Estimates* are only an expression of *Bonhams'* opinion made on behalf of the *Seller* of the range where *Bonhams* thinks the *Hammer Price* for the *Lot* is likely to fall; it is not an *Estimate* of value. It does not take into account any *VAT* or *Buyer's Premium* payable. *Lots* can in fact sell for *Hammer Prices* below and above the *Estimate*. Any *Estimate* should not be relied on as an indication of the actual selling price or value of a *Lot*. *Estimates* are in the currency of the *Sale*.

Condition Reports

In respect of most *Lots*, you may ask for a *Condition Report* on its physical condition from *Bonhams*. If you do so, this will be provided by *Bonhams* on behalf of the *Seller* free of charge. *Bonhams* is not entering into a contract with you in respect of the *Condition Report* and accordingly does not assume responsibility to you in respect of it. Nor does the *Seller* owe or agree to owe you as a *Bidder* any obligation or duty in respect of this free report about a *Lot*, which is available for your own inspection or for inspection by an expert instructed by you. However, any written *Description* of the physical condition of the *Lot* contained in a *Condition Report* will form part of the *Contractual Description* of the *Lot* under which it is sold to any *Buyer*.

The Seller's responsibility to you

The *Seller* does not make or agree to make any representation of fact or contractual promise, *Guarantee* or warranty and undertakes no obligation or duty, whether in contract or in tort (other than to the eventual *Buyer* as set out above), in respect of the accuracy or completeness of any statement or representation made by him or on his behalf, which is in any way descriptive of any *Lot* or as to the anticipated or likely selling price of any *Lot*. Other than as set out above, no statement or representation in any way descriptive of a *Lot* or any *Estimate* is incorporated into any *Contract for Sale* between a *Seller* and a *Buyer*.

Bonhams' responsibility to you

You have the opportunity of examining the *Lot* if you want to and the *Contract for Sale* for a *Lot* is with the *Seller* and not with *Bonhams*; *Bonhams* acts as the *Seller's* agent only (unless *Bonhams* sells the *Lot* as principal).

Bonhams undertakes no obligation to you to examine, investigate or carry out any tests, either in sufficient depth or at all, on each *Lot* to establish the accuracy or otherwise of any *Descriptions* or opinions given by *Bonhams*, or by any person on *Bonhams'* behalf, whether in the *Catalogue* or elsewhere.

You should not suppose that such examinations, investigations or tests have occurred.

Bonhams does not make or agree to make any representation of fact, and undertakes no obligation or duty (whether in contract or tort) in respect of the accuracy or completeness of any statement or representation made by *Bonhams* or on

Bonhams' behalf which is in any way descriptive of any *Lot* or as to the anticipated or likely selling price of any *Lot*. No statement or representation by *Bonhams* or on its behalf in any way descriptive of any *Lot* or any *Estimate* is incorporated into our *Buyer's Agreement*.

Alterations

Descriptions and *Estimates* may be amended at *Bonhams'* discretion from time to time by notice given orally or in writing before or during a *Sale*.

THE *LOT* IS AVAILABLE FOR INSPECTION AND YOU MUST FORM YOUR OWN OPINION IN RELATION TO IT. YOU ARE STRONGLY ADVISED TO EXAMINE ANY *LOT* OR HAVE IT EXAMINED ON YOUR BEHALF BEFORE THE *SALE*.

4. CONDUCT OF THE SALE

Our *Sales* are public auctions which persons may attend and you should take the opportunity to do so. We do reserve the right at our sole discretion to refuse admission to our premises or to any *Sale* without stating a reason. We have complete discretion as to whether the *Sale* proceeds, whether any *Lot* is included in the *Sale*, the manner in which the *Sale* is conducted and we may offer *Lots for Sale* in any order we choose notwithstanding the numbers given to *Lots* in the *Catalogue*. You should therefore check the date and starting time of the *Sale*, whether there have been any withdrawals or late entries. Remember that withdrawals and late entries may affect the time at which a *Lot* you are interested in is put up for *Sale*. We have complete discretion to refuse any bid, to nominate any bidding increment we consider appropriate, to divide any *Lot*, to combine two or more *Lots*, to withdraw any *Lot* from a *Sale* and, before the *Sale* has been closed, to put up any *Lot* for auction again. Auction speeds can exceed 100 *Lots* to the hour and bidding increments are generally about 10%. However these do vary from *Sale* to *Sale* and from *Auctioneer* to *Auctioneer*. Please check with the department organising the *Sale* for advice on this. Where a *Reserve* has been applied to a *Lot*, the *Auctioneer* may, in his absolute discretion, place bids (up to an amount not equalling or exceeding such *Reserve*) on behalf of the *Seller*. We are not responsible to you in respect of the presence or absence of any *Reserve* in respect of any *Lot*. If there is a *Reserve* it will normally be no higher than the lower figure for any *Estimate* in the *Catalogue*, assuming that the currency of the *Reserve* has not fluctuated adversely against the currency of the *Estimate*. The *Buyer* will be the *Bidder* who makes the highest bid acceptable to the *Auctioneer* for any *Lot* (subject to any applicable *Reserve*) to whom the *Lot* is knocked down by the *Auctioneer* at the fall of the *Auctioneer's* hammer. Any dispute as to the highest acceptable bid will be settled by the *Auctioneer* in his absolute discretion. All bids tendered will relate to the actual *Lot* number announced by the *Auctioneer*. An electronic currency converter may be used at the *Sale*. This equipment is provided as a general guide as to the equivalent amount in certain currencies of a given bid. We do not accept any responsibility for any errors which may occur in the use of the currency converter. We may use video cameras to record the *Sale* and may record telephone calls for reasons of security and to assist in solving any disputes which may arise in relation to bids made at the *Sale*. At some *Sales*, for example, jewellery *Sales*, we may use screens on which images of the *Lots* will be projected. This service is provided to assist viewing at the *Sale*. The image on the screen should be treated as an indication only of the current *Lot*. It should be noted that all bids tendered will relate to the actual *Lot* number announced by the *Auctioneer*. We do not accept any responsibility for any errors which may occur in the use of the screen.

5. BIDDING

We do not accept bids from any person who has not completed and delivered to us one of our *Bidding Forms*, either our *Bidder Registration Form*, *Absentee Bidding Form* or *Telephone Bidding Form*. You will be asked for proof of identity, residence and references, which, when asked for, you must supply if your bids are to be accepted by us. Please bring your passport, driving licence (or similar photographic proof of identity) and proof of address. We may request a deposit from you before allowing you to bid. We may refuse entry to a *Sale* to any person even if that person has completed a *Bidding Form*.

Bidding in person

You should come to our *Bidder* registration desk at the Sale venue and fill out a *Bidder* Registration Form on (or, if possible, before) the day of the Sale. The bidding number system is sometimes referred to as "paddle bidding". You will be issued with a large card (a "paddle") with a printed number on it. This will be attributed to you for the purposes of the Sale. Should you be a successful *Bidder* you will need to ensure that your number can be clearly seen by the *Auctioneer* and that it is your number which is identified as the *Buyer's*. You should not let anyone else use your paddle as all *Lots* will be invoiced to the name and address given on your *Bidder* Registration Form. Once an invoice is issued it will not be changed. If there is any doubt as to the *Hammer Price* of, or whether you are the successful *Bidder* of, a particular *Lot*, you must draw this to the attention of the *Auctioneer* before the next *Lot* is offered for Sale. At the end of the Sale, or when you have finished bidding please return your paddle to the *Bidder* registration desk.

Bidding by telephone

If you wish to bid at the Sale by telephone, please complete a Telephone *Bidding Form*, which is available from our offices or in the *Catalogue*. Please then return it to the office responsible for the Sale at least 24 hours in advance of the Sale. It is your responsibility to check with our Bids Office that your bid has been received. Telephone calls will be recorded. The telephone bidding facility is a discretionary service and may not be available in relation to all *Lots*. We will not be responsible for bidding on your behalf if you are unavailable at the time of the Sale or if the telephone connection is interrupted during bidding. Please contact us for further details.

Bidding by post or fax

Absentee Bidding Forms can be found in the back of this *Catalogue* and should be completed and sent to the office responsible for the Sale. It is in your interests to return your form as soon as possible, as if two or more *Bidders* submit identical bids for a *Lot*, the first bid received takes preference. In any event, all bids should be received at least 24 hours before the start of the Sale. Please check your *Absentee Bidding Form* carefully before returning it to us, fully completed and signed by you. It is your responsibility to check with our Bids Office that your bid has been received. This additional service is complimentary and is confidential. Such bids are made at your own risk and we cannot accept liability for our failure to receive and/or place any such bids. All bids made on your behalf will be made at the lowest level possible subject to *Reserves* and other bids made for the *Lot*. Where appropriate your bids will be rounded down to the nearest amount consistent with the *Auctioneer's* bidding increments. *New Bidders* must also provide proof of identity and address when submitting bids. Failure to do this will result in your bid not being placed.

Bidding via the internet

Please visit our *Website* at <http://www.bonhams.com> for details of how to bid via the internet.

Bidding through an agent

Bids will be accepted as placed on behalf of the person named as the principal on the *Bidding Form* although we may refuse to accept bids from an agent on behalf of a principal and will require written confirmation from the principal confirming the agent's authority to bid. Nevertheless, as the *Bidding Form* explains, any person placing a bid as agent on behalf of another (whether or not he has disclosed that fact or the identity of his principal) will be jointly and severally liable with the principal to the *Seller* and to *Bonhams* under any contract resulting from the acceptance of a bid. Subject to the above, please let us know if you are acting on behalf of another person when bidding for *Lots* at the Sale.

Equally, please let us know if you intend to nominate another person to bid on your behalf at the Sale unless this is to be carried out by us pursuant to a Telephone or *Absentee Bidding Form* that you have completed. If we do not approve the agency arrangements in writing before the Sale, we are entitled to assume that the person bidding at the Sale is bidding on his own behalf. Accordingly, the person bidding at the Sale will be the *Buyer* and will be liable to pay the *Hammer Price* and *Buyer's Premium* and associated charges. If we approve the identity of your client in advance, we will be in a position to

address the invoice to your principal rather than you. We will require proof of the agent's client's identity and residence in advance of any bids made by the agent on his behalf. Please refer to our *Conditions of Business* and contact our Customer Services Department for further details.

6. CONTRACTS BETWEEN THE BUYER AND SELLER AND THE BUYER AND BONHAMS

On the *Lot* being knocked down to the *Buyer*, a *Contract for Sale* of the *Lot* will be entered into between the *Seller* and the *Buyer* on the terms of the *Contract for Sale* set out in Appendix 1 at the back of the *Catalogue*. You will be liable to pay the *Purchase Price*, which is the *Hammer Price* plus any applicable VAT. At the same time, a separate contract is also entered into between us as *Auctioneers* and the *Buyer*. This is our *Buyer's Agreement*, the terms of which are set out in Appendix 2 at the back of the *Catalogue*. Please read the terms of the *Contract for Sale* and our *Buyer's Agreement* contained in the *Catalogue* in case you are the successful *Bidder*. We may change the terms of either or both of these agreements in advance of their being entered into, by setting out different terms in the *Catalogue* and/or by placing an insert in the *Catalogue* and/or by notices at the Sale venue and/or by oral announcements before and during the Sale. You should be alert to this possibility of changes and ask if there have been any.

7. BUYER'S PREMIUM AND OTHER CHARGES PAYABLE BY THE BUYER

Under the *Buyer's Agreement*, a premium (the *Buyer's Premium*) is payable to us by the *Buyer* in accordance with the terms of the *Buyer's Agreement* and at rates set out below, calculated by reference to the *Hammer Price* and payable in addition to it. Storage charges and *Expenses* are also payable by the *Buyer* as set out in the *Buyer's Agreement*. All the sums payable to us by the *Buyer* are subject to VAT. For this Sale the following rates of *Buyer's Premium* will be payable by *Buyers* on each lot purchased:

(a) Motor Cars and Motorcycles
15% on the first £50,000 of the *Hammer Price*
12% from £50,001 of the *Hammer Price*

(b) Automobilia
25% up to £50,000 of the *Hammer Price*
20% from £50,001 to £1,000,000 of the *Hammer Price*
12% from £1,000,001 of the *Hammer Price*

The *Buyer's premium* is payable for the services to be provided by *Bonhams* in the *Buyer's Agreement* which is contained in the *Catalogue* for this Sale and for the opportunity to bid for the *Lot* at the Sale.

On certain *Lots*, which will be marked "AR" in the *Catalogue* and which are sold for a *Hammer Price* of €1000 or greater (converted into the currency of the Sale using the European Central Bank Reference rate prevailing on the date of the Sale), the *Additional Premium* will be payable to us by the *Buyer* to cover our *Expenses* relating to the payment of royalties under the Artists ReSale Right Regulations 2006. The *Additional Premium* will be a percentage of the amount of the *Hammer Price* calculated in accordance with the table below, and shall not exceed €12,500 (converted into the currency of the Sale using the European Central Bank Reference rate prevailing on the date of the Sale).

<i>Hammer Price</i>	Percentage amount
From €0 to €50,000	4%
From €50,000.01 to €200,000	3%
From €200,000.01 to €350,000	1%
From €350,000.01 to €500,000	0.5%
Exceeding €500,000	0.25%

8. VAT

The prevailing rate of VAT at the time of going to press is 20%, but this is subject to government change and the rate payable will be the rate in force on the date of the Sale.

The following symbols are used to denote that VAT is due on the *Hammer Price* and *Buyer's Premium*:

† VAT at the prevailing rate on *Hammer Price* and *Buyer's Premium*

- Ω VAT on imported items at the prevailing rate on *Hammer Price* and *Buyer's Premium*
- * VAT on imported items at a preferential rate of 5% on *Hammer Price* and the prevailing rate on *Buyer's Premium*
- G Gold bullion exempt from VAT on the *Hammer Price* and subject to VAT at the prevailing rate on the *Buyer's Premium*
- Zero rated for VAT, no VAT will be added to the *Hammer Price* or the *Buyer's Premium*
- α *Buyers* from within the EU: VAT is payable at the prevailing rate on just the *Buyer's Premium* (NOT the *Hammer Price*). *Buyers* from outside the EU: VAT is payable at the prevailing rate on both *Hammer Price* and *Buyer's Premium*. If a *Buyer*, having registered under a non-EU address, decides that the item is not to be exported from the EU, then he should advise *Bonhams* immediately.

In all other instances no VAT will be charged on the *Hammer Price*, but VAT at the prevailing rate will be added to *Buyer's Premium* which will be invoiced on a VAT inclusive basis.

9. PAYMENT

It is of critical importance that you ensure that you have readily available funds to pay the *Purchase Price* and the *Buyer's Premium* (plus VAT and any other charges and *Expenses* to us) in full before making a bid for the *Lot*. If you are a successful *Bidder*, payment will be due to us by 4.30 pm on the second working day after the Sale so that all sums are cleared by the eighth working day after the Sale. Unless agreed by us in advance payments made by anyone other than the registered *Buyer* will not be accepted. Payment will have to be by one of the following methods (all cheques should be made payable to Bonhams 1793 Limited). *Bonhams* reserves the right to vary the terms of payment at any time.

Cash: you may pay for *Lots* purchased by you at this Sale with notes, coins or travellers cheques in the currency in which the Sale is conducted (but not any other currency) provided that the total amount payable by you in respect of all *Lots* purchased by you at the Sale does not exceed £3,000, or the equivalent in the currency in which the Sale is conducted, at the time when payment is made. If the amount payable by you for *Lots* exceeds that sum, the balance must be paid otherwise than in coins, notes or travellers cheques;

Bank transfer: you may electronically transfer funds to our *Trust Account*. If you do so, please quote your paddle number and invoice number as the reference. Our *Trust Account* details are as follows:

Bank: National Westminster Bank Plc
Address: PO Box 4RY
250 Regent Street
London W1A 4RY
Account Name: Bonhams 1793 Limited Trust Account
Account Number: 25563009
Sort Code: 56-00-27
IBAN Number: GB 33 NWBK 560027 25563009

If paying by bank transfer, the amount received after the deduction of any bank fees and/or conversion of the currency of payment to pounds sterling must not be less than the sterling amount payable, as set out on the invoice.

Debit cards: there is no additional charge for purchases made with personal debit cards, issued by a UK bank. Debit cards issued by an overseas bank, deferred and company debit cards and all credit cards will be subject to a 2% surcharge;

Credit cards: Visa and MasterCard only. Please note there is a 2% surcharge on the total invoice value when payments are made using credit cards. It may be advisable to notify your card provider of your intended purchase in advance to reduce delays caused by us having to seek authority when you come to pay. If you have any questions with regard to payment, please contact our Customer Services Department.

10. COLLECTION AND STORAGE

The *Buyer* of a *Lot* will not be allowed to collect it until payment in full and in cleared funds has been made (unless we have made a special arrangement with the *Buyer*). For collection and removal of purchased *Lots*, please refer to *Sale* Information at the front of the *Catalogue*. Our offices are open 9.00am – 5pm Monday to Friday. Details relating to the collection of a *Lot*, the storage of a *Lot* and our *Storage Contractor* after the *Sale* are set out in the *Catalogue*.

11. SHIPPING

Please refer all enquiries to our shipping department on:
Tel: +44 (0)20 8963 2850/2852 Fax: +44 (0)20 8963 2805
Email: shipping@bonhams.com

12. EXPORT/TRADE RESTRICTIONS

It is your sole responsibility to comply with all export and import regulations relating to your purchases and also to obtain any relevant export and/or import licence(s). Export licences are issued by Arts Council England and application forms can be obtained from its Export Licensing Unit. The detailed provisions of the export licencing arrangements can be found on the ACE website <http://www.artscouncil.org.uk/what-we-do/supporting-museums/cultural-property/export-controls/export-licensing/> or by phoning ACE on +44 (0)20 7973 5188. The need for import licences varies from country to country and you should acquaint yourself with all relevant local requirements and provisions. The refusal of any import or export licence(s) or any delay in obtaining such licence(s) shall not permit the rescission of any *Sale* nor allow any delay in making full payment for the *Lot*. Generally, please contact our shipping department before the *Sale* if you require assistance in relation to export regulations.

13. CITES REGULATIONS

Please be aware that all *Lots* marked with the symbol Y are subject to CITES regulations when exporting these items outside the EU. These regulations may be found at <http://www.defra.gov.uk/ahvla-en/imports-exports/cites/> or may be requested from:

Animal Health and Veterinary Laboratories Agency (AHVLA)
Wildlife Licencing
Floor 1, Zone 17, Temple Quay House
2 The Square, Temple Quay
BRISTOL BS1 6EB
Tel: +44 (0) 117 372 8774

14. THE SELLERS AND/OR BONHAMS' LIABILITY

Other than any liability of the *Seller* to the *Buyer* of a *Lot* under the *Contract for Sale*, neither we nor the *Seller* are liable (whether in negligence or otherwise) for any error or misdescription or omission in any *Description* of a *Lot* or any *Estimate* in respect of it, whether contained in the *Catalogue* or otherwise, whether given orally or in writing and whether given before or during the *Sale*. Neither we nor the *Seller* will be liable for any loss of *Business*, profits, revenue or income, or for loss of reputation, or for disruption to *Business* or wasted time on the part of management or staff, or for indirect losses or consequential damages of any kind, irrespective in any case of the nature, volume or source of the loss or damage alleged to be suffered, and irrespective of whether the said loss or damage is caused by or claimed in respect of any negligence, other tort, breach of contract (if any) or statutory duty, restitutionary claim or otherwise. In any circumstances where we and/or the *Seller* are liable in relation to any *Lot* or any *Description* or *Estimate* made of any *Lot*, or the conduct of any *Sale* in relation to any *Lot*, whether in damages, for an indemnity or contribution, or for a restitutionary remedy or otherwise, our and/or the *Seller's* liability (combined, if both we and the *Seller* are liable) will be limited to payment of a sum which will not exceed by way of maximum the amount of the *Purchase Price* of the *Lot* irrespective in any case of the nature, volume or source of any loss or damage alleged to be suffered or sum claimed as due, and irrespective of whether the liability arises from any negligence, other tort, breach of contract (if any) or statutory duty or otherwise. Nothing set out above will be construed as excluding or restricting (whether directly or indirectly) our liability or excluding or restricting any person's

rights or remedies in respect of (i) fraud, or (ii) death or personal injury caused by our negligence (or by the negligence of any person under our control or for whom we are legally responsible), or (iii) acts or omissions for which we are liable under the Occupiers Liability Act 1957, or (iv) any other liability to the extent the same may not be excluded or restricted as a matter of law or (v) our undertakings under paragraphs 9 (in relation to specialist *Stamp* or *Book Sales* only) and 10 of the *Buyer's Agreement*. The same applies in respect of the *Seller*, as if references to us in this paragraph were substituted with references to the *Seller*.

15. BOOKS

As stated above, all *Lots* are sold on an "as is" basis, subject to all faults, imperfections and errors of *Description* save as set out below. However, you will be entitled to reject a *Book* in the circumstances set out in paragraph 10 of the *Buyer's Agreement*. Please note that *Lots* comprising printed *Books*, unframed maps and bound manuscripts are not liable to VAT on the *Buyer's Premium*.

16. CLOCKS AND WATCHES

All *Lots* are sold "as is", and the absence of any reference to the condition of a clock or watch does not imply that the *Lot* is in good condition and without defects, repairs or restorations. Most clocks and watches have been repaired in the course of their normal lifetime and may now incorporate parts not original to them. Furthermore, *Bonhams* makes no representation or warranty that any clock or watch is in working order. As clocks and watches often contain fine and complex mechanisms, *Bidders* should be aware that a general service, change of battery or further repair work, for which the *Buyer* is solely responsible, may be necessary. *Bidders* should be aware that the importation of watches such as Rolex, Frank Muller and Corum into the United States is highly restricted. These watches may not be shipped to the USA and can only be imported personally.

17. FIREARMS – PROOF, CONDITION AND CERTIFICATION

Proof of Firearms

The term "proof exemption" indicates that a firearm has been examined at a Proof House, but not proved, as either (a) it was deemed of interest and not intended for use, or (b) ammunition was not available. In either case, the firearm must be regarded as unsafe to fire unless subsequently proved. Firearms proved for Black Powder should not be used with smokeless ammunition.

The term "Certificate of Unprovability" indicates that a firearm has been examined at a Proof House and is deemed both unsuitable for proof and use. Reproof is required before any such firearm is to be used.

Guns Sold as Parts

Barrels of guns sold as parts will only be made available for sleeving and measurements once rendered unserviceable according to the Gun Barrel Proof Act of 1968 to 1978 and the Rules of Proof.

Condition of Firearms

Comment in this *Catalogue* is restricted, in general, to exceptional condition and to those defects that might affect the immediate safety of a firearm in normal use. An intending *Bidder* unable to make technical examinations and assessments is recommended to seek advice from a gunmaker or from a modern firearms specialist. All prospective *Bidders* are advised to consult the ° of bore and wall-thickness measurements posted in the saleroom and available from the department. *Bidders* should note that guns are stripped only where there is a strong indication of a mechanical malfunction. Stripping is not, otherwise, undertaken. Guns intended for use should be stripped and cleaned beforehand. Hammer guns should have their rebound mechanisms checked before use. The safety mechanisms of all guns must be tested before use. All measurements are approximate.

Original Gun Specifications Derived from Gunmakers

The Sporting Gun Department endeavours to confirm a gun's original specification and date of manufacture with makers who hold their original records.

Licensing Requirements

Firearms Act 1968 as amended

Bonhams is constantly reviewing its procedures and would remind you that, in the case of firearms or shotguns subject to certification, to conform with current legislation, *Bonhams* is required to see, as appropriate, your original registered firearms dealer's certificate / shot gun certificate / firearm certificate / museum firearms licence / Section 5 authority or import licence (or details of any exemption from which you may benefit, for instance Crown servant status) for the firearm(s) you have purchased prior to taking full payment of the amount shown on your invoice. Should you not already be in possession of such an authority or exemption, you are required to initially pay a deposit of 95% of the total invoice with the balance of 5% payable on presentation of your valid certificate or licence showing your authority to hold the firearm(s) concerned.

Please be advised that if a successful *Bidder* is then unable to produce the correct paperwork, the *Lot(s)* will be reoffered by *Bonhams* in the next appropriate *Sale*, on standard terms for *Sellers*, and you will be responsible for any loss incurred by *Bonhams* on the original *Sale* to you.

In the case of RFD certificates and Section 5 authorities, we wish to keep an up-to-date copy on file. Please supply us with a Fax or photocopy. It would be helpful if you could send us an updated copy whenever your certificate or authority is renewed or changed.

Lots marked 'S1' and bearing red labels are Section 1 firearms and require a valid British Firearms certificate, RFD Licence or import licence.

Lots marked 'S2' and bearing blue labels are Section 2 firearms and require a valid British Shotgun certificate, RFD licence or import licence.

Lots marked 'S5' and bearing specially marked red labels are Section 5 prohibited firearms and require a valid Section 5 Authority or import licence.

Lots marked with a 'S58' and bearing yellow labels are for obsolete calibres and no licence is required unless ammunition is held.

Unmarked *Lots* require no licence.

Please do not hesitate to contact the Modern Sporting Gun Department should you have any queries.

Taxidermy and Related Items

As a *Seller* of these articles, *Bonhams* undertakes to comply fully with Cites and DEFRA regulations. *Buyers* are advised to inform themselves of all such regulations and should expect the exportation of items to take some time to arrange.

18. FURNITURE

Upholstered Furniture

Whilst we take every care in cataloguing furniture which has been upholstered we offer no *Guarantee* as to the originality of the wood covered by fabric or upholstery.

19. JEWELLERY

~ Ruby and Jadeite

Ruby and jadeite gemstones of Burmese (Myanmar) origin may not be imported into the US. Rubies and jadeite of non-Burmese origin require certification before import into the US and it is the *Buyer's* responsibility to obtain all relevant and required export/import licences, certificates and documentation before shipping. Failure by the *Buyer* to successfully import goods into the US does not constitute grounds for non payment or cancellation of *Sale*. *Bonhams* will not be responsible for any additional costs in this regard howsoever incurred.

Gemstones

Historically many gemstones have been subjected to a variety of treatments to enhance their appearance. Sapphires and rubies are routinely heat treated to improve their colour and clarity, similarly emeralds are frequently treated with oils or resin for the same purpose. Other treatments such as staining, irradiation or coating may have been used on other gemstones. These treatments may be permanent, whilst others may need special care or re-treatment over the years to retain their appearance. *Bidders* should be aware that *Estimates* assume that gemstones may have been subjected to such treatments. A number of laboratories issue certificates that give more detailed *Descriptions* of gemstones. However there may not be consensus between different laboratories on the degrees, or types of treatment for any particular gemstone. In the event that *Bonhams* has been given or has obtained certificates for any *Lot* in the *Sale* these certificates will be disclosed in the *Catalogue*. Although, as a matter of policy, *Bonhams* endeavours to provide certificates from recognised laboratories for certain gemstones, it is not feasible to obtain certificates for each *Lot*. In the event that no certificate is published in the *Catalogue*, *Bidders* should assume that the gemstones may have been treated. Neither *Bonhams* nor the *Seller* accepts any liability for contradictions or differing certificates obtained by *Buyers* on any *Lots* subsequent to the *Sale*.

Estimated Weights

If a stone(s) weight appears within the body of the *Description* in capital letters, the stone(s) has been unmounted and weighed by *Bonhams*. If the weight of the stone(s) is stated to be approximate and does not appear in capital letters, the stone(s) has been assessed by us within its/their settings, and the stated weight is a statement of our opinion only. This information is given as a guide and *Bidders* should satisfy themselves with regard to this information as to its accuracy.

Signatures

1. A diamond brooch, by Kutchinsky

When the maker's name appears in the title, in *Bonhams'* opinion the piece is by that maker.

2. A diamond brooch, signed Kutchinsky

Has a signature that, in *Bonhams'* opinion, is authentic but may contain gemstones that are not original, or the piece may have been altered.

3. A diamond brooch, mounted by Kutchinsky

Has been created by the jeweller, in *Bonhams'* opinion, but using stones or designs supplied by the client.

20. PHOTOGRAPHS

Explanation of Catalogue Terms

- "Bill Brandt": in our opinion a work by the artist.
- "Attributed to Bill Brandt": in our opinion probably a work by the artist, but less certainty to authorship is expressed than in the preceding category.
- "Signed and/or titled and/or dated and/or inscribed": in our opinion the signature and/or title and/or date and/or inscription are in the artist's hand.
- "Signed and/or titled and/or dated and/or inscribed in another hand": in our opinion the signature and/or title and/or date and/or inscription have been added by another hand.

- The date given is that of the image (negative). Where no further date is given, this indicates that the photographic print is vintage (the term "vintage" may also be included in the *Lot Description*). A vintage photograph is one which was made within approximately 5-10 years of the negative. Where a second, later date appears, this refers to the date of printing. Where the exact printing date is not known, but understood to be later, "printed later" will appear in the *Lot Description*.
- Unless otherwise specified, dimensions given are those of the piece of paper on which the image is printed, including any margins. Some photographs may appear in the *Catalogue* without margins illustrated.
- All photographs are sold unframed unless stated in the *Lot Description*.

21. PICTURES

Explanation of Catalogue Terms

The following terms used in the *Catalogue* have the following meanings but are subject to the general provisions relating to *Descriptions* contained in the *Contract for Sale*:

- "Jacopo Bassano": in our opinion a work by the artist. When the artist's forename(s) is not known, a series of asterisks, followed by the surname of the artist, whether preceded by an initial or not, indicates that in our opinion the work is by the artist named;
- "Attributed to Jacopo Bassano": in our opinion probably a work by the artist but less certainty as to authorship is expressed than in the preceding category;
- "Studio/Workshop of Jacopo Bassano": in our opinion a work by an unknown hand in a studio of the artist which may or may not have been executed under the artist's direction;
- "Circle of Jacopo Bassano": in our opinion a work by a hand closely associated with a named artist but not necessarily his pupil;
- "Follower of Jacopo Bassano": in our opinion a work by a painter working in the artist's style, contemporary or nearly contemporary, but not necessarily his pupil;
- "Manner of Jacopo Bassano": in our opinion a work in the style of the artist and of a later date;
- "After Jacopo Bassano": in our opinion, a copy of a known work of the artist;
- "Signed and/or dated and/or inscribed": in our opinion the signature and/or date and/or inscription are from the hand of the artist;
- "Bears a signature and/or date and/or inscription": in our opinion the signature and/or date and/or inscription have been added by another hand.

22. PORCELAIN AND GLASS

Damage and Restoration

For your guidance, in our *Catalogues* we detail, as far as practicable, recorded all significant defects, cracks and restoration. Such practicable *Descriptions* of damage cannot be definitive, and in providing *Condition Reports*, we cannot *Guarantee* that there are no other defects present which have not been mentioned. *Bidders* should satisfy themselves by inspection, as to the condition of each *Lot*. Please see the *Contract for Sale* printed in this *Catalogue*. Because of the difficulty in determining whether an item of glass has been repolished, in our *Catalogues* reference is only made to visible chips and cracks. No mention is made of repolishing, severe or otherwise.

23. VEHICLES

The Veteran Car Club of Great Britain

Dating Plates and Certificates

When mention is made of a Veteran Car Club Dating Plate or Dating Certificate in this *Catalogue*, it should be borne in mind that the Veteran Car Club of Great Britain using the services of Veteran Car Company Ltd, does from time to time, review cars already dated and, in some instances, where fresh evidence becomes available, the review can result in an alteration of date. Whilst the Club and Veteran Car Company Ltd make every effort to ensure accuracy, the date shown on the Dating Plate or Dating Certificate cannot be guaranteed as correct and intending purchasers should make their own enquiries as to the date of the car.

24. WINE

Lots which are lying under Bond and those liable to VAT may not be available for immediate collection.

Examining the wines

It is occasionally possible to provide a pre-Sale tasting for larger parcels (as defined below). This is generally limited to more recent and everyday drinking wines. Please contact the department for details.

It is not our policy to inspect every unopened case. In the case of wines older than 20 years the boxes will usually have been opened and levels and appearance noted in the *Catalogue* where necessary. You should make proper allowance for variations in ullage levels and conditions of corks, capsules and labels.

Corks and Ullages

Ullage refers to the space between the base of the cork and the wine. Ullage levels for Bordeaux shaped bottles are only normally noted when below the neck and for Burgundy, Alsace, German and Cognac shaped bottles when greater than 4 centimetres (cm). Acceptable ullage levels increase with age; generally acceptable levels are as follows:

Under 15 years old – into neck or less than 4cm
15 to 30 years old – top shoulder (ts) or up to 5cm
Over 30 years old – high shoulder (hs) or up to 6cm

It should be noted that ullages may change between publication of the *Catalogue* and the *Sale* and that corks may fail as a result of transporting the wine. We will only accept responsibility for *Descriptions* of condition at the time of publication of the *Catalogue* and cannot accept responsibility for any loss resulting from failure of corks either before or after this point.

Options to buy parcels

A parcel is a number of *Lots* of identical size of the same wine, bottle size and *Description*. The *Buyer* of any of these *Lots* has the option to accept some or all of the remaining *Lots* in the parcel at the same price, although such options will be at the *Auctioneer's* sole discretion. Absentee *Bidders* are, therefore, advised to bid on the first *Lot* in a parcel.

Wines in Bond

Wines lying in Bond are marked Δ and VAT is payable by the purchaser, at the standard rate, on the *Hammer Price*, unless the wines are to remain under Bond. *Buyers* requiring their wine to remain in Bond must notify *Bonhams* at the time of the *Sale*. The *Buyer* is then himself responsible for all duty, clearance VAT and other charges that may be payable thereon. All such *Lots* must be transferred or collected within two weeks of the *Sale*.

Buyers outside the UK must be aware that any forwarding agent appointed to export their purchases must have a movement certificate for *Lots* to be released under Bond.

Bottling Details and Case Terms

The following terms used in the *Catalogue* have the following meanings:

CB – Château bottled
DB – Domaine bottled
EstB – Estate bottled
BB – Bordeaux bottled
BE – Belgian bottled
FB – French bottled
GB – German bottled
OB – Oporto bottled
UK – United Kingdom bottled
owc – original wooden case
iwc – individual wooden case
oc – original carton

SYMBOLS

THE FOLLOWING SYMBOLS ARE USED TO DENOTE

- Y Subject to CITES regulations when exporting these items outside the EU, see clause 13.
- W Objects displayed with a w will be located in the Bonhams Warehouse and will only be available for collection from this location.
- ≈ Please note that as a result of recent legislation ruby and jadeite gem stones of Burmese (Myanmar) origin may not be imported into the US. Rubies and jadeite of non-Burmese origin require certification before import into the US.
- Δ Wines lying in Bond.
- AR An *Additional Premium* will be payable to us by the *Buyer* to cover our *Expenses* relating to payment of royalties under the Artists Resale Right Regulations 2006. See clause 7 for details.
- The *Seller* has been guaranteed a minimum price for the *Lot*, either by *Bonhams* or a third party. This may take the form of an irrevocable bid by a third party, who may make a financial gain on a successful *Sale* or a financial loss if unsuccessful.
- ▲ *Bonhams* owns the *Lot* either wholly or partially or may otherwise have an economic interest.
- Φ This lot contains or is made of ivory. The United States Government has banned the import of ivory into the USA.

•, †, *, G, Ω, α see clause 8, VAT, for details.

DATA PROTECTION – USE OF YOUR INFORMATION

Where we obtain any personal information about you, we shall only use it in accordance with the terms of our Privacy Policy (subject to any additional specific consent(s) you may have given at the time your information was disclosed). A copy of our Privacy Policy can be found on our Website www.bonhams.com or requested by post from Customer Services Department, 101 New Bond Street, London, W1S 1SR or by email from info@bonhams.com

APPENDIX 1

CONTRACT FOR SALE

IMPORTANT: These terms may be changed in advance of the *Sale* of the *Lot* to you, by the setting out of different terms in the *Catalogue* for the *Sale* and/or by placing an insert in the *Catalogue* and/or by notices at the *Sale* venue and/or by oral announcements before and during the *Sale* at the *Sale* venue. You should be alert to this possibility of changes and ask in advance of bidding if there have been any.

Under this contract the *Seller's* liability in respect of the quality of the *Lot*, its fitness for any purpose and its conformity with any *Description* is limited. You are strongly advised to examine the *Lot* for yourself and/or obtain an independent examination of it before you buy it.

1 THE CONTRACT

- 1.1 These terms govern the *Contract for Sale* of the *Lot* by the *Seller* to the *Buyer*.
- 1.2 The Definitions and Glossary contained in Appendix 3 in the *Catalogue* are incorporated into this *Contract for Sale* and a separate copy can also be provided by *Bonhams* on request. Where words and phrases are used which are in the List of Definitions, they are printed in italics.
- 1.3 The *Seller* sells the *Lot* as the principal to the *Contract for Sale*, such contract being made between the *Seller* and you through *Bonhams* which acts in the sole capacity as the *Seller's* agent and not as an additional principal. However, if the *Catalogue* states that *Bonhams* sells the *Lot* as principal, or such a statement is made by an announcement by the *Auctioneer*, or by a notice at the *Sale*, or an insert in the *Catalogue*, then *Bonhams* is the *Seller* for the purposes of this agreement.
- 1.4 The contract is made on the fall of the *Auctioneer's* hammer in respect of the *Lot* when it is knocked down to you.

2 SELLER'S UNDERTAKINGS

- 2.1 The *Seller* undertakes to you that:
- 2.1.1 the *Seller* is the owner of the *Lot* or is duly authorised to sell the *Lot* by the owner;
- 2.1.2 save as disclosed in the *Entry* for the *Lot* in the *Catalogue*, the *Seller* sells the *Lot* with full title guarantee or, where the *Seller* is an executor, trustee, liquidator, receiver or administrator, with whatever right, title or interest he may have in the *Lot*;
- 2.1.3 except where the *Sale* is by an executor, trustee, liquidator, receiver or administrator the *Seller* is both legally entitled to sell the *Lot*, and legally capable of conferring on you quiet possession of the *Lot* and that the *Sale* conforms in every respect with the terms implied by the Sale of Goods Act 1979, Sections 12(1) and 12(2) (see the Definitions and Glossary);
- 2.1.4 the *Seller* has complied with all requirements, legal or otherwise, relating to any export or import of the *Lot*, and all duties and taxes in respect of the export or import of the *Lot* have (unless stated to the contrary in the *Catalogue* or announced by the *Auctioneer*) been paid and, so far as the *Seller* is aware, all third parties have complied with such requirements in the past;
- 2.1.5 subject to any alterations expressly identified as such made by announcement or notice at the *Sale* venue or by the *Notice to Bidders* or by an insert in the *Catalogue*, the *Lot* corresponds with the *Contractual Description* of the *Lot*, being that part of the *Entry* about the *Lot* in the *Catalogue* which is in bold letters and (except for colour) with any photograph of the *Lot* in the *Catalogue* and the contents of any *Condition Report* which has been provided to the *Buyer*.

3 DESCRIPTIONS OF THE LOT

- 3.1 Paragraph 2.1.5 sets out what is the *Contractual Description* of the *Lot*. In particular, the *Lot* is not sold as corresponding with that part of the *Entry* in the *Catalogue* which is not printed in bold letters, which merely sets out (on the *Seller's* behalf) *Bonhams' opinion* about the *Lot* and which is not part of the *Contractual Description* upon which the *Lot* is sold. Any statement or representation other than that part of the *Entry* referred to in paragraph 2.1.5 (together with any express alteration to it as referred to in paragraph 2.1.5), including any *Description* or *Estimate*, whether made orally or in writing, including in the *Catalogue* or on *Bonhams' Website*, or by conduct, or otherwise, and whether by or on behalf of the *Seller* or *Bonhams* and whether made prior to or during the *Sale*, is not part of the *Contractual Description* upon which the *Lot* is sold.
- 3.2 Except as provided in paragraph 2.1.5, the *Seller* does not make or give and does not agree to make or give any contractual promise, undertaking, obligation, guarantee, warranty, or representation of fact, or undertake any duty of care, in relation to any *Description* of the *Lot* or any *Estimate* in relation to it, nor of the accuracy or completeness of any *Description* or *Estimate* which may have been made by or on behalf of the *Seller* including by *Bonhams*. No such *Description* or *Estimate* is incorporated into this *Contract for Sale*.
- 4 FITNESS FOR PURPOSE AND SATISFACTORY QUALITY
- 4.1 The *Seller* does not make and does not agree to make any contractual promise, undertaking, obligation, guarantee, warranty, or representation of fact in relation to the satisfactory quality of the *Lot* or its fitness for any purpose.

- 4.2 The *Seller* will not be liable for any breach of any undertaking, whether implied by the Sale of Goods Act 1979 or otherwise, as to the satisfactory quality of the *Lot* or its fitness for any purpose.

5 RISK, PROPERTY AND TITLE

- 5.1 Risk in the *Lot* passes to you when it is knocked down to you on the fall of the *Auctioneer's* hammer in respect of the *Lot*. The *Seller* will not be responsible thereafter for the *Lot* prior to you collecting it from *Bonhams* or the *Storage Contractor*, with whom you have separate contract(s) as *Buyer*. You will indemnify the *Seller* and keep the *Seller* fully indemnified from and against all claims, proceedings, costs, expenses and losses arising in respect of any injury, loss and damage caused to the *Lot* after the fall of the *Auctioneer's* hammer until you obtain full title to it.
- 5.2 Title to the *Lot* remains in and is retained by the *Seller* until the *Purchase Price* and all other sums payable by you to *Bonhams* in relation to the *Lot* have been paid in full to, and received in cleared funds by, *Bonhams*.

6 PAYMENT

- 6.1 Your obligation to pay the *Purchase Price* arises when the *Lot* is knocked down to you on the fall of the *Auctioneer's* hammer in respect of the *Lot*.
- 6.2 Time will be of the essence in relation to payment of the *Purchase Price* and all other sums payable by you to *Bonhams*. Unless agreed in writing with you by *Bonhams* on the *Seller's* behalf (in which case you must comply with the terms of that agreement), all such sums must be paid to *Bonhams* by you in the currency in which the *Sale* was conducted by not later than 4.30pm on the second working day following the *Sale* and you must ensure that the funds are cleared by the seventh working day after the *Sale*. Payment must be made to *Bonhams* by one of the methods stated in the *Notice to Bidders* unless otherwise agreed with you in writing by *Bonhams*. If you do not pay any sums due in accordance with this paragraph, the *Seller* will have the rights set out in paragraph 8 below.

7 COLLECTION OF THE LOT

- 7.1 Unless otherwise agreed in writing with you by *Bonhams*, the *Lot* will be released to you or to your order only when *Bonhams* has received cleared funds to the amount of the full *Purchase Price* and all other sums owed by you to the *Seller* and to *Bonhams*.
- 7.2 The *Seller* is entitled to withhold possession from you of any other *Lot* he has sold to you at the same or at any other *Sale* and whether currently in *Bonhams' possession* or not until payment in full and in cleared funds of the *Purchase Price* and all other sums due to the *Seller* and/or *Bonhams* in respect of the *Lot*.
- 7.3 You will collect and remove the *Lot* at your own expense from *Bonhams' custody* and/or control or from the *Storage Contractor's* custody in accordance with *Bonhams' instructions* or requirements.
- 7.4 You will be wholly responsible for packing, handling and transport of the *Lot* on collection and for complying with all import or export regulations in connection with the *Lot*.
- 7.5 You will be wholly responsible for any removal, storage or other charges or *Expenses* incurred by the *Seller* if you do not remove the *Lot* in accordance with this paragraph 7 and will indemnify the *Seller* against all charges, costs, including any legal costs and fees, *Expenses* and losses suffered by the *Seller* by reason of your failure to remove the *Lot* including any charges due under any *Storage Contract*. All such sums due to the *Seller* will be payable on demand.

8	FAILURE TO PAY FOR THE LOT	behalf in respect of the <i>Lot</i> , after the payment of all sums due to the <i>Seller</i> and to <i>Bonhams</i> , within 28 days of receipt of such monies by him or on his behalf.	not operate or be deemed to operate as a waiver of his rights under it except to the extent of any express waiver given to you in writing. Any such waiver will not affect the <i>Seller's</i> ability subsequently to enforce any right arising under the <i>Contract for Sale</i> .
8.1	If the <i>Purchase Price</i> for a <i>Lot</i> is not paid to <i>Bonhams</i> in full in accordance with the <i>Contract for Sale</i> the <i>Seller</i> will be entitled, with the prior written agreement of <i>Bonhams</i> but without further notice to you, to exercise one or more of the following rights (whether through <i>Bonhams</i> or otherwise):	9	THE SELLER'S LIABILITY
8.1.1	to terminate immediately the <i>Contract for Sale</i> of the <i>Lot</i> for your breach of contract;	9.1	The <i>Seller</i> will not be liable for any injury, loss or damage caused by the <i>Lot</i> after the fall of the <i>Auctioneer's</i> hammer in respect of the <i>Lot</i> .
8.1.2	to resell the <i>Lot</i> by auction, private treaty or any other means on giving seven days' written notice to you of the intention to resell;	9.2	Subject to paragraph 9.3 below, except for breach of the express undertaking provided in paragraph 2.1.5, the <i>Seller</i> will not be liable for any breach of any term that the <i>Lot</i> will correspond with any <i>Description</i> applied to it by or on behalf of the <i>Seller</i> , whether implied by the Sale of Goods Act 1979 or otherwise.
8.1.3	to retain possession of the <i>Lot</i> ;	9.3	Unless the <i>Seller</i> sells the <i>Lot</i> in the course of a <i>Business</i> and the <i>Buyer</i> buys it as a <i>Consumer</i> ,
8.1.4	to remove and store the <i>Lot</i> at your expense;	9.3.1	the <i>Seller</i> will not be liable (whether in negligence, other tort, breach of contract or statutory duty or in restitution or under the Misrepresentation Act 1967, or in any other way) for any lack of conformity with, or inaccuracy, error, misdescription or omission in any <i>Description</i> of the <i>Lot</i> or any <i>Entry</i> or <i>Estimate</i> in relation to the <i>Lot</i> made by or on behalf of the <i>Seller</i> (whether made in writing, including in the <i>Catalogue</i> , or on the <i>Website</i> , or orally, or by conduct or otherwise) and whether made before or after this agreement or prior to or during the <i>Sale</i> ;
8.1.5	to take legal proceedings against you for any sum due under the <i>Contract for Sale</i> and/or damages for breach of contract;	9.3.2	the <i>Seller</i> will not be liable for any loss of <i>Business</i> , <i>Business</i> profits or revenue or income or for loss of reputation or for disruption to <i>Business</i> or wasted time on the part of the <i>Buyer</i> or of the <i>Buyer's</i> management or staff or, for any indirect losses or consequential damages of any kind, irrespective in any case of the nature, volume or source of the loss or damage alleged to be suffered, and irrespective of whether the said loss or damage is caused by or claimed in respect of any negligence, other tort, breach of contract, statutory duty, restitutionary claim or otherwise;
8.1.6	to be paid interest on any monies due (after as well as before judgement or order) at the annual rate of 5% per annum above the base rate of National Westminster Bank Plc from time to time to be calculated on a daily basis from the date upon which such monies become payable until the date of actual payment;	9.3.3	in any circumstances where the <i>Seller</i> is liable to you in respect of the <i>Lot</i> , or any act, omission, statement, or representation in respect of it, or this agreement or its performance, and whether in damages, for an indemnity or contribution or for a restitutionary remedy or in any way whatsoever, the <i>Seller's</i> liability will be limited to payment of a sum which will not exceed by way of maximum the amount of the <i>Purchase Price</i> of the <i>Lot</i> irrespective in any case of the nature, volume or source of any loss or damage alleged to be suffered or sum claimed as due, and irrespective of whether the liability arises from any negligence, other tort, breach of contract, statutory duty, bailee's duty, restitutionary claim or otherwise.
8.1.7	to repossess the <i>Lot</i> (or any part thereof) which has not become your property, and for this purpose (unless the <i>Buyer</i> buys the <i>Lot</i> as a <i>Consumer</i> from the <i>Seller</i> selling in the course of a <i>Business</i>) you hereby grant an irrevocable licence to the <i>Seller</i> by himself and to his servants or agents to enter upon all or any of your premises (with or without vehicles) during normal <i>Business</i> hours to take possession of the <i>Lot</i> or part thereof;	9.4	Nothing set out in paragraphs 9.1 to 9.3 above will be construed as excluding or restricting (whether directly or indirectly) any person's liability or excluding or restricting any person's rights or remedies in respect of (i) fraud, or (ii) death or personal injury caused by the <i>Seller's</i> negligence (or any person under the <i>Seller's</i> control or for whom the <i>Seller</i> is legally responsible), or (iii) acts or omissions for which the <i>Seller</i> is liable under the Occupiers Liability Act 1957, or (iv) any other liability to the extent the same may not be excluded or restricted as a matter of law.
8.1.8	to retain possession of any other property sold to you by the <i>Seller</i> at the <i>Sale</i> or any other auction or by private treaty until all sums due under the <i>Contract for Sale</i> shall have been paid in full in cleared funds;	10	MISCELLANEOUS
8.1.9	to retain possession of, and on seven days written notice to sell, <i>Without Reserve</i> , any of your other property in the possession of the <i>Seller</i> and/or of <i>Bonhams</i> (as bailee for the <i>Seller</i>) for any purpose (including, without limitation, other goods sold to you) and to apply any monies due to you as a result of such <i>Sale</i> in satisfaction or part satisfaction of any amounts owed to the <i>Seller</i> or to <i>Bonhams</i> ; and	10.1	You may not assign either the benefit or burden of the <i>Contract for Sale</i> .
8.1.10	so long as such goods remain in the possession of the <i>Seller</i> or <i>Bonhams</i> as its bailee, to rescind the contract for the <i>Sale</i> of any other goods sold to you by the <i>Seller</i> at the <i>Sale</i> or at any other auction or by private treaty and apply any monies received from you in respect of such goods in part or full satisfaction of any amounts owed to the <i>Seller</i> or to <i>Bonhams</i> by you.	10.2	The <i>Seller's</i> failure or delay in enforcing or exercising any power or right under the <i>Contract for Sale</i> will
8.2	You agree to indemnify the <i>Seller</i> against all legal and other costs of enforcement, all losses and other <i>Expenses</i> and costs (including any monies payable to <i>Bonhams</i> in order to obtain the release of the <i>Lot</i>) incurred by the <i>Seller</i> (whether or not court proceedings will have been issued) as a result of <i>Bonhams</i> taking steps under this paragraph 8 on a full indemnity basis together with interest thereon (after as well as before judgement or order) at the rate specified in paragraph 8.1.6 from the date upon which the <i>Seller</i> becomes liable to pay the same until payment by you.	10.3	If either party to the <i>Contract for Sale</i> is prevented from performing that party's respective obligations under the <i>Contract for Sale</i> by circumstances beyond its reasonable control or if performance of its obligations would by reason of such circumstances give rise to a significantly increased financial cost to it, that party will not, for so long as such circumstances prevail, be required to perform such obligations. This paragraph does not apply to the obligations imposed on you by paragraph 6.
8.3	On any resale of the <i>Lot</i> under paragraph 8.1.2, the <i>Seller</i> will account to you in respect of any balance remaining from any monies received by him or on his	10.4	Any notice or other communication to be given under the <i>Contract for Sale</i> must be in writing and may be delivered by hand or sent by first class post or air mail or fax transmission, if to the <i>Seller</i> , addressed c/o <i>Bonhams</i> at its address or fax number in the <i>Catalogue</i> (marked for the attention of the Company Secretary), and if to you to the address or fax number of the <i>Buyer</i> given in the <i>Bidding Form</i> (unless notice of any change of address is given in writing). It is the responsibility of the sender of the notice or communication to ensure that it is received in a legible form within any applicable time period.
		10.5	If any term or any part of any term of the <i>Contract for Sale</i> is held to be unenforceable or invalid, such unenforceability or invalidity will not affect the enforceability and validity of the remaining terms or the remainder of the relevant term.
		10.6	References in the <i>Contract for Sale</i> to <i>Bonhams</i> will, where appropriate, include reference to <i>Bonhams'</i> officers, employees and agents.
		10.7	The headings used in the <i>Contract for Sale</i> are for convenience only and will not affect its interpretation.
		10.8	In the <i>Contract for Sale</i> "including" means "including, without limitation".
		10.9	References to the singular will include reference to the plural (and vice versa) and reference to any one gender will include reference to the other genders.
		10.10	Reference to a numbered paragraph is to a paragraph of the <i>Contract for Sale</i> .
		10.11	Save as expressly provided in paragraph 10.12 nothing in the <i>Contract for Sale</i> confers (or purports to confer) on any person who is not a party to the <i>Contract for Sale</i> any benefit conferred by, or the right to enforce any term of, the <i>Contract for Sale</i> .
		10.12	Where the <i>Contract for Sale</i> confers an immunity from, and/or an exclusion or restriction of, the responsibility and/or liability of the <i>Seller</i> , it will also operate in favour and for the benefit of <i>Bonhams</i> , <i>Bonhams'</i> holding company and the subsidiaries of such holding company and the successors and assigns of <i>Bonhams</i> and of such companies and of any officer, employee and agent of <i>Bonhams</i> and such companies, each of whom will be entitled to rely on the relevant immunity and/or exclusion and/or restriction within and for the purposes of Contracts (Rights of Third Parties) Act 1999, which enables the benefit of a contract to be extended to a person who is not a party to the contract, and generally at law.

11 GOVERNING LAW

All transactions to which the *Contract for Sale* applies and all connected matters will be governed by and construed in accordance with the laws of that part of the United Kingdom where the *Sale* takes place and the *Seller* and you each submit to the exclusive jurisdiction of the courts of that part of the United Kingdom, save that the *Seller* may bring proceedings against you in any other court of competent jurisdiction to the extent permitted by the laws of the relevant jurisdiction. *Bonhams* has a complaints procedure in place.

APPENDIX 2

BUYER'S AGREEMENT

IMPORTANT: These terms may be changed in advance of the *Sale* of the *Lot* to you, by the setting out of different terms in the *Catalogue* for the *Sale* and/or by placing an insert in the *Catalogue* and/or by notices at the *Sale* venue and/or by oral announcements before and during the *Sale* at the *Sale* venue. You should be alert to this possibility of changes and ask in advance of bidding if there have been any.

1 THE CONTRACT

- 1.1 These terms govern the contract between *Bonhams* personally and the *Buyer*, being the person to whom a *Lot* has been knocked down by the *Auctioneer*.
- 1.2 The Definitions and Glossary contained in Appendix 3 to the *Catalogue* for the *Sale* are incorporated into this agreement and a separate copy can also be provided by us on request. Where words and phrases which are defined in the List of Definitions are used in this agreement, they are printed in italics. Reference is made in this agreement to information printed in the *Notice to Bidders*, printed in the *Catalogue* for the *Sale*, and where such information is referred to it is incorporated into this agreement.
- 1.3 Except as specified in paragraph 4 of the *Notice to Bidders* the *Contract for Sale* of the *Lot* between you and the *Seller* is made on the fall of the *Auctioneer's* hammer in respect of the *Lot*, when it is knocked down to you. At that moment a separate contract is also made between you and *Bonhams* on the terms in this *Buyer's Agreement*.
- 1.4 We act as agents for the *Seller* and are not answerable or personally responsible to you for any breach of contract or other default by the *Seller*, unless *Bonhams* sells the *Lot* as principal.
- 1.5 Our personal obligations to you are governed by this agreement and we agree, subject to the terms below, to the following obligations:
 - 1.5.1 we will, until the date and time specified in the *Notice to Bidders* or otherwise notified to you, store the *Lot* in accordance with paragraph 5;
 - 1.5.2 subject to any power of the *Seller* or us to refuse to release the *Lot* to you, we will release the *Lot* to you in accordance with paragraph 4 once you have paid to us, in cleared funds, everything due to us and the *Seller*;
 - 1.5.3 we will provide guarantees in the terms set out in paragraphs 9 and 10.
- 1.6 We do not make or give and do not agree to make or give any contractual promise, undertaking, obligation, *Guarantee*, warranty, representation of fact in relation to any *Description* of the *Lot* or any *Estimate* in relation to it, nor of the accuracy or completeness of any *Description* or *Estimate* which may have been made by us or on our behalf or by or on behalf of the *Seller* (whether made orally or in

writing, including in the *Catalogue* or on *Bonhams' Website*, or by conduct, or otherwise), and whether made before or after this agreement or prior to or during the *Sale*. No such *Description* or *Estimate* is incorporated into this agreement between you and us. Any such *Description* or *Estimate*, if made by us or on our behalf, was (unless *Bonhams* itself sells the *Lot* as principal) made as agent on behalf of the *Seller*.

2 PERFORMANCE OF THE CONTRACT FOR SALE

You undertake to us personally that you will observe and comply with all your obligations and undertakings to the *Seller* under the *Contract for Sale* in respect of the *Lot*.

3 PAYMENT

- 3.1 Unless agreed in writing between you and us or as otherwise set out in the *Notice to Bidders*, you must pay to us by not later than 4.30pm on the second working day following the *Sale*:
 - 3.1.1 the *Purchase Price* for the *Lot*;
 - 3.1.2 a *Buyer's Premium* in accordance with the rates set out in the *Notice to Bidders* on each lot, and
 - 3.1.3 if the *Lot* is marked [AR], an *Additional Premium* which is calculated and payable in accordance with the *Notice to Bidders* together with VAT on that sum if applicable so that all sums due to us are cleared funds by the seventh working day after the *Sale*.
- 3.2 You must also pay us on demand any *Expenses* payable pursuant to this agreement.
- 3.3 All payments to us must be made in the currency in which the *Sale* was conducted, using, unless otherwise agreed by us in writing, one of the methods of payment set out in the *Notice to Bidders*. Our invoices will only be addressed to the registered *Bidder* unless the *Bidder* is acting as an agent for a named principal and we have approved that arrangement, in which case we will address the invoice to the principal.
- 3.4 Unless otherwise stated in this agreement all sums payable to us will be subject to VAT at the appropriate rate and VAT will be payable by you on all such sums.
- 3.5 We may deduct and retain for our own benefit from the monies paid by you to us the *Buyer's Premium*, the *Commission* payable by the *Seller* in respect of the *Lot*, any *Expenses* and VAT and any interest earned and/or incurred until payment to the *Seller*.
- 3.6 Time will be of the essence in relation to any payment payable to us. If you do not pay the *Purchase Price*, or any other sum due to us in accordance with this paragraph 3, we will have the rights set out in paragraph 7 below.
- 3.7 Where a number of *Lots* have been knocked down to you, any monies we receive from you will be applied firstly pro-rata to pay the *Purchase Price* of each *Lot* and secondly pro-rata to pay all amounts due to *Bonhams*.

4 COLLECTION OF THE LOT

- 4.1 Subject to any power of the *Seller* or us to refuse to release the *Lot* to you, once you have paid to us, in cleared funds, everything due to the *Seller* and to us, we will release the *Lot* to you or as you may direct us in writing. The *Lot* will only be released on production of a buyer collection document, obtained from our cashier's office.

- 4.2 You must collect and remove the *Lot* at your own expense by the date and time specified in the *Notice to Bidders*, or if no date is specified, by 4.30pm on the seventh day after the *Sale*.
 - 4.3 For the period referred to in paragraph 4.2, the *Lot* can be collected from the address referred to in the *Notice to Bidders* for collection on the days and times specified in the *Notice to Bidders*. Thereafter, the *Lot* may be removed elsewhere for storage and you must enquire from us as to when and where you can collect it, although this information will usually be set out in the *Notice to Bidders*.
 - 4.4 If you have not collected the *Lot* by the date specified in the *Notice to Bidders*, you authorise us, acting as your agent and on your behalf, to enter into a contract (the "*Storage Contract*") with the *Storage Contractor* for the storage of the *Lot* on the then current standard terms and conditions agreed between *Bonhams* and the *Storage Contractor* (copies of which are available on request). If the *Lot* is stored at our premises storage fees at our current daily rates (currently a minimum of £3 plus VAT per *Lot* per day) will be payable from the expiry of the period referred to in paragraph 4.2. These storage fees form part of our *Expenses*.
 - 4.5 Until you have paid the *Purchase Price* and any *Expenses* in full the *Lot* will either be held by us as agent on behalf of the *Seller* or held by the *Storage Contractor* as agent on behalf of the *Seller* and ourselves on the terms contained in the *Storage Contract*.
 - 4.6 You undertake to comply with the terms of any *Storage Contract* and in particular to pay the charges (and all costs of moving the *Lot* into storage) due under any *Storage Contract*. You acknowledge and agree that you will not be able to collect the *Lot* from the *Storage Contractor's* premises until you have paid the *Purchase Price*, any *Expenses* and all charges due under the *Storage Contract*.
 - 4.7 You will be wholly responsible for packing, handling and transport of the *Lot* on collection and for complying with all import or export regulations in connection with the *Lot*.
 - 4.8 You will be wholly responsible for any removal, storage, or other charges for any *Lot* not removed in accordance with paragraph 4.2, payable at our current rates, and any *Expenses* we incur (including any charges due under the *Storage Contract*), all of which must be paid by you on demand and in any event before any collection of the *Lot* by you or on your behalf.
- ### 5 STORING THE LOT
- We agree to store the *Lot* until the earlier of your removal of the *Lot* or until the time and date set out in the *Notice to Bidders*, on the *Sale Information Page* or at the back of the catalogue (or if no date is specified, by 4.30pm on the seventh day after the *Sale*) and, subject to paragraphs 6 and 10, to be responsible as *bailee* to you for damage to or the loss or destruction of the *Lot* (notwithstanding that it is not your property before payment of the *Purchase Price*). If you do not collect the *Lot* before the time and date set out in the *Notice to Bidders* (or if no date is specified, by 4.30pm on the seventh day after the *Sale*) we may remove the *Lot* to another location, the details of which will usually be set out in the relevant section of the *Catalogue*. If you have not paid for the *Lot* in accordance with paragraph 3, and the *Lot* is moved to any third party's premises, the *Lot* will be held by such third party strictly to *Bonhams' order* and we will retain our lien over the *Lot* until we have been paid in full in accordance with paragraph 3.

6	RESPONSIBILITY FOR THE LOT	7.2	You agree to indemnify us against all legal and other costs, all losses and all other <i>Expenses</i> (whether or not court proceedings will have been issued) incurred by us as a result of our taking steps under this paragraph 7 on a full indemnity basis together with interest thereon (after as well as before judgement or order) at the rate specified in paragraph 7.1.5 from the date upon which we become liable to pay the same until payment by you.	9.2.2	you notify us in writing as soon as reasonably practicable after you have become aware that the <i>Lot</i> is or may be a <i>Forgery</i> , and in any event within one year after the <i>Sale</i> , that the <i>Lot</i> is a <i>Forgery</i> ; and
6.1	Only on the payment of the <i>Purchase Price</i> to us will title in the <i>Lot</i> pass to you. However under the <i>Contract for Sale</i> , the risk in the <i>Lot</i> passed to you when it was knocked down to you.			9.2.3	within one month after such notification has been given, you return the <i>Lot</i> to us in the same condition as it was at the time of the <i>Sale</i> , accompanied by written evidence that the <i>Lot</i> is a <i>Forgery</i> and details of the <i>Sale</i> and <i>Lot</i> number sufficient to identify the <i>Lot</i> .
6.2	You are advised to obtain insurance in respect of the <i>Lot</i> as soon as possible after the <i>Sale</i> .			9.3	Paragraph 9 will not apply in respect of a <i>Forgery</i> if:
7	FAILURE TO PAY OR TO REMOVE THE LOT AND PART PAYMENTS	7.3	If you pay us only part of the sums due to us such payment shall be applied firstly to the <i>Purchase Price</i> of the <i>Lot</i> (or where you have purchased more than one <i>Lot</i> pro-rata towards the <i>Purchase Price</i> of each <i>Lot</i>) and secondly to the <i>Buyer's Premium</i> (or where you have purchased more than one <i>Lot</i> pro-rata to the <i>Buyer's Premium</i> on each <i>Lot</i>) and thirdly to any other sums due to us.	9.3.1	the <i>Entry</i> in relation to the <i>Lot</i> contained in the <i>Catalogue</i> reflected the then accepted general opinion of scholars and experts or fairly indicated that there was a conflict of such opinion or reflected the then current opinion of an expert acknowledged to be a leading expert in the relevant field; or
7.1	If all sums payable to us are not so paid in full at the time they are due and/or the <i>Lot</i> is not removed in accordance with this agreement, we will without further notice to you be entitled to exercise one or more of the following rights (without prejudice to any rights we may exercise on behalf of the <i>Seller</i>):	7.4	We will account to you in respect of any balance we hold remaining from any monies received by us in respect of any <i>Sale</i> of the <i>Lot</i> under our rights under this paragraph 7 after the payment of all sums due to us and/or the <i>Seller</i> within 28 days of receipt by us of all such sums paid to us.	9.3.2	it can be established that the <i>Lot</i> is a <i>Forgery</i> only by means of a process not generally accepted for use until after the date on which the <i>Catalogue</i> was published or by means of a process which it was unreasonable in all the circumstances for us to have employed.
7.1.1	to terminate this agreement immediately for your breach of contract;				
7.1.2	to retain possession of the <i>Lot</i> ;				
7.1.3	to remove, and/or store the <i>Lot</i> at your expense;				
7.1.4	to take legal proceedings against you for payment of any sums payable to us by you (including the <i>Purchase Price</i>) and/or damages for breach of contract;	8	CLAIMS BY OTHER PERSONS IN RESPECT OF THE LOT		
7.1.5	to be paid interest on any monies due to us (after as well as before judgement or order) at the annual rate of 5% per annum above the base lending rate of National Westminster Bank Plc from time to time to be calculated on a daily basis from the date upon which such monies become payable until the date of actual payment;	8.1	Whenever it becomes apparent to us that the <i>Lot</i> is the subject of a claim by someone other than you and other than the <i>Seller</i> (or that such a claim can reasonably be expected to be made), we may, at our absolute discretion, deal with the <i>Lot</i> in any manner which appears to us to recognise the legitimate interests of ourselves and the other parties involved and lawfully to protect our position and our legitimate interests. Without prejudice to the generality of the discretion and by way of example, we may:	9.4	You authorise us to carry out such processes and tests on the <i>Lot</i> as we in our absolute discretion consider necessary to satisfy ourselves that the <i>Lot</i> is or is not a <i>Forgery</i> .
7.1.6	to repossess the <i>Lot</i> (or any part thereof) which has not become your property, and for this purpose (unless you buy the <i>Lot</i> as a <i>Consumer</i>) you hereby grant an irrevocable licence to us, by ourselves, our servants or agents, to enter upon all or any of your premises (with or without vehicles) during normal business hours to take possession of any <i>Lot</i> or part thereof;	8.1.1	retain the <i>Lot</i> to investigate any question raised or reasonably expected by us to be raised in relation to the <i>Lot</i> ; and/or	9.5	If we are satisfied that a <i>Lot</i> is a <i>Forgery</i> we will (as principal) purchase the <i>Lot</i> from you and you will transfer the title to the <i>Lot</i> in question to us, with full title guarantee, free from any liens, charges, encumbrances and adverse claims, in accordance with the provisions of Sections 12(1) and 12(2) of the Sale of Goods Act 1979 and we will pay to you an amount equal to the sum of the <i>Purchase Price</i> , <i>Buyer's Premium</i> , <i>VAT</i> and <i>Expenses</i> paid by you in respect of the <i>Lot</i> .
7.1.7	to sell the <i>Lot Without Reserve</i> by auction, private treaty or any other means on giving you three months' written notice of our intention to do so;	8.1.2	deliver the <i>Lot</i> to a person other than you; and/or	9.6	The benefit of paragraph 9 is personal to, and incapable of assignment by, you.
7.1.8	to retain possession of any of your other property in our possession for any purpose (including, without limitation, other goods sold to you or with us for <i>Sale</i>) until all sums due to us have been paid in full;	8.1.3	commence interpleader proceedings or seek any other order of any court, mediator, arbitrator or government body; and/or	9.7	If you sell or otherwise dispose of your interest in the <i>Lot</i> , all rights and benefits under this paragraph will cease.
7.1.9	to apply any monies received from you for any purpose whether at the time of your default or at any time thereafter in payment or part payment of any sums due to us by you under this agreement;	8.1.4	require an indemnity and/or security from you in return for pursuing a course of action agreed to by you.	9.8	Paragraph 9 does not apply to a <i>Lot</i> made up of or including a Chinese painting or Chinese paintings, a motor vehicle or motor vehicles, a <i>Stamp</i> or <i>Stamps</i> or a <i>Book</i> or <i>Books</i> .
7.1.10	on three months' written notice to sell, <i>Without Reserve</i> , any of your other property in our possession or under our control for any purpose (including other goods sold to you or with us for <i>Sale</i>) and to apply any monies due to you as a result of such <i>Sale</i> in payment or part payment of any amounts owed to us;	8.2	The discretion referred to in paragraph 8.1:		
7.1.11	refuse to allow you to register for a future <i>Sale</i> or to reject a bid from you at any future <i>Sale</i> or to require you to pay a deposit before any bid is accepted by us at any future <i>Sale</i> in which case we will be entitled to apply such deposit in payment or part payment, as the case may be, of the <i>Purchase Price</i> of any <i>Lot</i> of which you are the <i>Buyer</i> .	8.2.1	may be exercised at any time during which we have actual or constructive possession of the <i>Lot</i> , or at any time after such possession, where the cessation of such possession has occurred by reason of any decision, order or ruling of any court, mediator, arbitrator or government body; and	10	OUR LIABILITY
		8.2.2	will not be exercised unless we believe that there exists a serious prospect of a good arguable case in favour of the claim.	10.1	We will not be liable whether in negligence, other tort, breach of contract or statutory duty or in restitution or under the Misrepresentation Act 1967 or in any other way for lack of conformity with or any inaccuracy, error, misdescription or omission in any <i>Description</i> of the <i>Lot</i> or any <i>Entry</i> or <i>Estimate</i> in respect of it, made by us or on our behalf or by or on behalf of the <i>Seller</i> (whether made in writing, including in the <i>Catalogue</i> , or on the <i>Bonhams' Website</i> , or orally, or by conduct or otherwise) and whether made before or after this agreement or prior to or during the <i>Sale</i> .
		9	FORGERIES	10.2	Our duty to you while the <i>Lot</i> is at your risk and/or your property and in our custody and/or control is to exercise reasonable care in relation to it, but we will not be responsible for damage to the <i>Lot</i> or to other persons or things caused by:
		9.1	We undertake a personal responsibility for any <i>Forgery</i> in accordance with the terms of this paragraph 9.	10.2.1	handling the <i>Lot</i> if it was affected at the time of <i>Sale</i> to you by woodworm and any damage is caused as a result of it being affected by woodworm; or
		9.2	Paragraph 9 applies only if:		
		9.2.1	your name appears as the named person to whom the original invoice was made out by us in respect of the <i>Lot</i> and that invoice has been paid; and		

- 10.2.2 changes in atmospheric pressure; nor will we be liable for:
- 10.2.3 damage to tension stringed musical instruments; or
- 10.2.4 damage to gilded picture frames, plaster picture frames or picture frame glass; and if the *Lot* is or becomes dangerous, we may dispose of it without notice to you in advance in any manner we think fit and we will be under no liability to you for doing so.
- 10.3.1 We will not be liable to you for any loss of *Business*, *Business* profits, revenue or income or for loss of *Business* reputation or for disruption to *Business* or wasted time on the part of the *Buyer's* management or staff or, if you are buying the *Lot* in the course of a *Business*, for any indirect losses or consequential damages of any kind, irrespective in any case of the nature, volume or source of the loss or damage alleged to be suffered, and irrespective of whether the said loss or damage is caused by or claimed in respect of any negligence, other tort, breach of contract, statutory duty, bailee's duty, a restitutionary claim or otherwise.
- 10.3.2 Unless you buy the *Lot* as a *Consumer*, in any circumstances where we are liable to you in respect of a *Lot*, or any act, omission, statement, representation in respect of it, or this agreement or its performance, and whether in damages, for an indemnity or contribution or for a restitutionary remedy or in any way whatsoever, our liability will be limited to payment of a sum which will not exceed by way of maximum the amount of the *Purchase Price* of the *Lot* plus *Buyer's Premium* (less any sum you may be entitled to recover from the *Seller*) irrespective in any case of the nature, volume or source of any loss or damage alleged to be suffered or sum claimed as due, and irrespective of whether the liability arises from negligence, other tort, breach of contract, statutory duty, bailee's duty, a restitutionary claim or otherwise.
- You may wish to protect yourself against loss by obtaining insurance.
- 10.4 Nothing set out above will be construed as excluding or restricting (whether directly or indirectly) any person's liability or excluding or restricting any person's rights or remedies in respect of (i) fraud, or (ii) death or personal injury caused by our negligence (or any person under our control or for whom we are legally responsible), or (iii) acts or omissions for which we are liable under the Occupiers Liability Act 1957, or (iv) any other liability to the extent the same may not be excluded or restricted as a matter of law, or (v) under our undertaking in paragraph 9 of these conditions.

11 MISCELLANEOUS

- 11.1 You may not assign either the benefit or burden of this agreement.
- 11.2 Our failure or delay in enforcing or exercising any power or right under this agreement will not operate or be deemed to operate as a waiver of our rights under it except to the extent of any express waiver given to you in writing. Any such waiver will not affect our ability subsequently to enforce any right arising under this agreement.
- 11.3 If either party to this agreement is prevented from performing that party's respective obligations under this agreement by circumstances beyond its reasonable control or if performance of its obligations would by reason of such circumstances give rise to a significantly increased financial cost to it, that party will not, for so long as such circumstances prevail, be required to perform such obligations. This paragraph does not apply to the obligations imposed on you by paragraph 3.

- 11.4 Any notice or other communication to be given under this agreement must be in writing and may be delivered by hand or sent by first class post or air mail or fax transmission (if to *Bonhams* marked for the attention of the Company Secretary), to the address or fax number of the relevant party given in the *Contract Form* (unless notice of any change of address is given in writing). It is the responsibility of the sender of the notice or communication to ensure that it is received in a legible form within any applicable time period.
- 11.5 If any term or any part of any term of this agreement is held to be unenforceable or invalid, such unenforceability or invalidity will not affect the enforceability and validity of the remaining terms or the remainder of the relevant term.
- 11.6 References in this agreement to *Bonhams* will, where appropriate, include reference to *Bonhams'* officers, employees and agents.
- 11.7 The headings used in this agreement are for convenience only and will not affect its interpretation.
- 11.8 In this agreement "including" means "including, without limitation".
- 11.9 References to the singular will include reference to the plural (and vice versa) and reference to any one gender will include reference to the other genders.
- 11.10 Reference to a numbered paragraph is to a paragraph of this agreement.
- 11.11 Save as expressly provided in paragraph 11.12 nothing in this agreement confers (or purports to confer) on any person who is not a party to this agreement any benefit conferred by, or the right to enforce any term of, this agreement.
- 11.12 Where this agreement confers an immunity from, and/or an exclusion or restriction of, the responsibility and/or liability of *Bonhams*, it will also operate in favour and for the benefit of *Bonhams'* holding company and the subsidiaries of such holding company and the successors and assigns of *Bonhams* and of such companies and of any officer, employee and agent of *Bonhams* and such companies, each of whom will be entitled to rely on the relevant immunity and/or exclusion and/or restriction within and for the purposes of Contracts (Rights of Third Parties) Act 1999, which enables the benefit of a contract to be extended to a person who is not a party to the contract, and generally at law.

12 GOVERNING LAW

All transactions to which this agreement applies and all connected matters will be governed by and construed in accordance with the laws of that part of the United Kingdom where the *Sale* takes (or is to take) place and we and you each submit to the exclusive jurisdiction of the courts of that part of the United Kingdom, save that we may bring proceedings against you in any other court of competent jurisdiction to the extent permitted by the laws of the relevant jurisdiction. *Bonhams* has a complaints procedure in place.

DATA PROTECTION – USE OF YOUR INFORMATION

Where we obtain any personal information about you, we shall only use it in accordance with the terms of our Privacy Policy (subject to any additional specific consent(s) you may have given at the time your information was disclosed). A copy of our Privacy Policy can be found on our *Website* www.bonhams.com or requested by post from Customer Services Department, 101 New Bond Street, London W1S 1SR, United Kingdom or by email from info@bonhams.com.

APPENDIX 3

DEFINITIONS AND GLOSSARY

Where these Definitions and Glossary are incorporated, the following words and phrases used have (unless the context otherwise requires) the meanings given to them below. The Glossary is to assist you to understand words and phrases which have a specific legal meaning with which you may not be familiar.

LIST OF DEFINITIONS

"Additional Premium" a premium, calculated in accordance with the *Notice to Bidders*, to cover *Bonhams'* Expenses relating to the payment of royalties under the Artists Resale Right Regulations 2006 which is payable by the *Buyer* to *Bonhams* on any *Lot* marked [AR] which sells for a *Hammer Price* which together with the *Buyer's Premium* (but excluding any VAT) equals or exceeds 1000 euros (converted into the currency of the *Sale* using the European Central Bank Reference rate prevailing on the date of the *Sale*).

"Auctioneer" the representative of *Bonhams* conducting the *Sale*.

"Bidder" a person who has completed a *Bidding Form*.

"Bidding Form" our Bidding Registration Form, our Absentee Bidding Form or our Telephone Bidding Form.

"Bonhams" Bonhams 1793 Limited or its successors or assigns. *Bonhams* is also referred to in the *Buyer's Agreement*, the Conditions of Business and the *Notice to Bidders* by the words "we", "us" and "our".

"Book" a printed *Book* offered for *Sale* at a specialist *Book Sale*.

"Business" includes any trade, *Business* and profession.

"Buyer" the person to whom a *Lot* is knocked down by the *Auctioneer*. The *Buyer* is also referred to in the *Contract for Sale* and the *Buyer's Agreement* by the words "you" and "your".

"Buyer's Agreement" the contract entered into by *Bonhams* with the *Buyer* (see Appendix 2 in the *Catalogue*).

"Buyer's Premium" the sum calculated on the *Hammer Price* at the rates stated in the *Notice to Bidders*.

"Catalogue" the *Catalogue* relating to the relevant *Sale*, including any representation of the *Catalogue* published on our *Website*.

"Commission" the *Commission* payable by the *Seller* to *Bonhams* calculated at the rates stated in the *Contract Form*.

"Condition Report" a report on the physical condition of a *Lot* provided to a *Bidder* or potential *Bidder* by *Bonhams* on behalf of the *Seller*.

"Conditions of Sale" the *Notice to Bidders*, *Contract for Sale*, *Buyer's Agreement* and Definitions and Glossary.

"Consignment Fee" a fee payable to *Bonhams* by the *Seller* calculated at rates set out in the Conditions of Business.

"Consumer" a natural person who is acting for the relevant purpose outside his trade, *Business* or profession.

"Contract Form" the *Contract Form*, or vehicle *Entry* form, as applicable, signed by or on behalf of the *Seller* listing the *Lots* to be offered for *Sale* by *Bonhams*.

"Contract for Sale" the *Sale* contract entered into by the *Seller* with the *Buyer* (see Appendix 1 in the *Catalogue*).

"Contractual Description" the only *Description* of the *Lot* (being that part of the *Entry* about the *Lot* in the *Catalogue* which is in bold letters, any photograph (except for the colour) and the contents of any *Condition Report*) to which the *Seller* undertakes in the *Contract for Sale* the *Lot* corresponds.

"Description" any statement or representation in any way descriptive of the *Lot*, including any statement or representation relating to its authorship, attribution, condition, provenance, authenticity, style, period, age, suitability, quality, origin, value, estimated selling price (including the *Hammer Price*).

"Entry" a written statement in the *Catalogue* identifying the *Lot* and its *Lot* number which may contain a *Description* and illustration(s) relating to the *Lot*.

"Estimate" a statement of our opinion of the range within which the hammer is likely to fall.

"Expenses" charges and *Expenses* paid or payable by *Bonhams* in respect of the *Lot* including legal *Expenses*, banking charges and *Expenses* incurred as a result of an electronic transfer of money, charges and *Expenses* for loss and damage cover, insurance, *Catalogue* and other reproductions and illustrations, any customs duties, advertising, packing or shipping costs, reproductions rights' fees, taxes, levies, costs of testing, searches or enquiries, preparation of the *Lot* for *Sale*, storage charges, removal charges, removal charges or costs of collection from the *Seller* as the *Seller's* agents or from a defaulting *Buyer*, plus *VAT* if applicable.

"Forgery" an imitation intended by the maker or any other person to deceive as to authorship, attribution, origin, authenticity, style, date, age, period, provenance, culture, source or composition, which at the date of the *Sale* had a value materially less than it would have had if the *Lot* had not been such an imitation, and which is not stated to be such an imitation in any description of the *Lot*. A *Lot* will not be a *Forgery* by reason of any damage to, and/or restoration and/or modification work (including repainting or over painting) having been carried out on the *Lot*, where that damage, restoration or modification work (as the case may be) does not substantially affect the identity of the *Lot* as one conforming to the *Description* of the *Lot*.

"Guarantee" the obligation undertaken personally by *Bonhams* to the *Buyer* in respect of any *Forgery* and, in the case of specialist *Stamp Sales* and/or specialist *Book Sales*, a *Lot* made up of a *Stamp* or *Stamps* or a *Book* or *Books* as set out in the *Buyer's Agreement*.

"Hammer Price" the price in the currency in which the *Sale* is conducted at which a *Lot* is knocked down by the *Auctioneer*.

"Loss and Damage Warranty" means the warranty described in paragraph 8.2 of the *Conditions of Business*.

"Loss and Damage Warranty Fee" means the fee described in paragraph 8.2.3 of the *Conditions of Business*.

"Lot" any item consigned to *Bonhams* with a view to its *Sale* at auction or by private treaty (and reference to any *Lot* will include, unless the context otherwise requires, reference to individual items comprised in a group of two or more items offered for *Sale* as one *Lot*).

"Motoring Catalogue Fee" a fee payable by the *Seller* to *Bonhams* in consideration of the additional work undertaken by *Bonhams* in respect of the cataloguing of motor vehicles and in respect of the promotion of *Sales* of motor vehicles.

"New Bond Street" means *Bonhams'* saleroom at 101 New Bond Street, London W1S 1SR.

"Notional Charges" the amount of *Commission* and *VAT* which would have been payable if the *Lot* had been sold at the *Notional Price*.

"Notional Fee" the sum on which the *Consignment Fee* payable to *Bonhams* by the *Seller* is based and which is calculated according to the formula set out in the *Conditions of Business*.

"Notional Price" the latest in time of the average of the high and low *Estimates* given by us to you or stated in the *Catalogue* or, if no such *Estimates* have been given or stated, the *Reserve* applicable to the *Lot*.

"Notice to Bidders" the notice printed at the back or front of our *Catalogues*.

"Purchase Price" the aggregate of the *Hammer Price* and *VAT* on the *Hammer Price* (where applicable), the *Buyer's Premium* and *VAT* on the *Buyer's Premium* and any *Expenses*.

"Reserve" the minimum price at which a *Lot* may be sold (whether at auction or by private treaty).

"Sale" the auction *Sale* at which a *Lot* is to be offered for *Sale* by *Bonhams*.

"Sale Proceeds" the net amount due to the *Seller* from the *Sale* of a *Lot*, being the *Hammer Price* less the *Commission*, any *VAT* chargeable thereon, *Expenses* and any other amount due to us in whatever capacity and howsoever arising.

"Seller" the person who offers the *Lot* for *Sale* named on the *Contract Form*. Where the person so named identifies on the form another person as acting as his agent, or where the person named on the *Contract Form* acts as an agent for a principal (whether such agency is disclosed to *Bonhams* or not), *"Seller"* includes both the agent and the principal who shall be jointly and severally liable as such. The *Seller* is also referred to in the *Conditions of Business* by the words "you" and "your".

"Specialist Examination" a visual examination of a *Lot* by a specialist on the *Lot*.

"Stamp" means a postage *Stamp* offered for *Sale* at a Specialist *Stamp Sale*.

"Standard Examination" a visual examination of a *Lot* by a non-specialist member of *Bonhams'* staff.

"Storage Contract" means the contract described in paragraph 8.3.3 of the *Conditions of Business* or paragraph 4.4 of the *Buyer's Agreement* (as appropriate).

"Storage Contractor" means the company identified as such in the *Catalogue*.

"Terrorism" means any act or threatened act of terrorism, whether any person is acting alone or on behalf of or in connection with any organisation(s) and/or government(s), committed for political, religious or ideological or similar purposes including, but not limited to, the intention to influence any government and/or put the public or any section of the public into fear.

"Trust Account" the bank account of *Bonhams* into which all sums received in respect of the *Purchase Price* of any *Lot* will be paid, such account to be a distinct and separate account to *Bonhams'* normal business bank account.

"VAT" value added tax at the prevailing rate at the date of the *Sale* in the United Kingdom.

"Website" *Bonhams Website* at www.bonhams.com

"Withdrawal Notice" the *Seller's* written notice to *Bonhams* revoking *Bonhams'* instructions to sell a *Lot*.

"Without Reserve" where there is no minimum price at which a *Lot* may be sold (whether at auction or by private treaty).

GLOSSARY

The following expressions have specific legal meanings with which you may not be familiar. The following glossary is intended to give you an understanding of those expressions but is not intended to limit their legal meanings:

"artist's resale right": the right of the creator of a work of art to receive a payment on *Sales* of that work subsequent to the original *Sale* of that work by the creator of it as set out in the Artists Resale Right Regulations 2006.

"bailee": a person to whom goods are entrusted.

"indemnity": an obligation to put the person who has the benefit of the indemnity in the same position in which he would have been, had the circumstances giving rise to the indemnity not arisen and the expression "indemnity" is construed accordingly.

"interpleader proceedings": proceedings in the Courts to determine ownership or rights over a *Lot*.

"knocked down": when a *Lot* is sold to a *Bidder*, indicated by the fall of the hammer at the *Sale*.

"lien": a right for the person who has possession of the *Lot* to retain possession of it.

"risk": the possibility that a *Lot* may be lost, damaged, destroyed, stolen, or deteriorate in condition or value.

"title": the legal and equitable right to the ownership of a *Lot*.

"tort": a legal wrong done to someone to whom the wrong doer has a duty of care.

SALE OF GOODS ACT 1979

The following is an extract from the Sale of Goods Act 1979:

"Section 12 Implied terms about title, etc

- (1) In a contract of sale, other than one to which subsection (3) below applies, there is an implied term on the part of the seller that in the case of a sale he has a right to sell the goods, and in the case of an agreement to sell he will have such a right at the time when the property is to pass.
- (2) In a contract of sale, other than one to which subsection (3) below applies, there is also an implied term that-
 - (a) the goods are free, and will remain free until the time when the property is to pass, from any charge or encumbrance not disclosed or known to the buyer before the contract is made, and
 - (b) the buyer will enjoy quiet possession of the goods except in so far as it may be disturbed by the owner or other person entitled to the benefit of any charge or encumbrance so disclosed or known.

- (3) This subsection applies to a contract of sale in the case of which there appears from the contract or is to be inferred from its circumstances an intention that the seller should transfer only such title as he or a third person may have.
- (4) In a contract to which subsection (3) above applies there is an implied term that all charges or encumbrances known to the seller and not known to the buyer have been disclosed to the buyer before the contract is made.
- (5) In a contract to which subsection (3) above applies there is also an implied term that none of the following will disturb the buyer's quiet possession of the goods, namely:
 - (a) the seller;
 - (b) in a case where the parties to the contract intend that the seller should transfer only such title as a third person may have, that person;
 - (c) anyone claiming through or under the seller or that third person otherwise than under a charge or encumbrance disclosed or known to the buyer before the contract is made.
- (5A) As regards England and Wales and Northern Ireland, the term implied by subsection (1) above is a condition and the terms implied by subsections (2), (4) and (5) above are warranties."

Registration and Bidding Form

(Attendee / Absentee / Online / Telephone Bidding)

Please circle your bidding method above.

--	--	--	--

Paddle number (for office use only)

This sale will be conducted in accordance with Bonhams' Conditions of Sale and bidding and buying at the Sale will be regulated by these Conditions. You should read the Conditions in conjunction with the Sale Information relating to this Sale which sets out the charges payable by you on the purchases you make and other terms relating to bidding and buying at the Sale. You should ask any questions you have about the Conditions before signing this form. These Conditions also contain certain undertakings by bidders and buyers and limit Bonhams' liability to bidders and buyers.

Data protection – use of your information

Where we obtain any personal information about you, we shall only use it in accordance with the terms of our Privacy Policy (subject to any additional specific consent(s) you may have given at the time your information was disclosed). A copy of our Privacy Policy can be found on our website (www.bonhams.com) or requested by post from Customer Services Department, 101 New Bond Street, London W1S 1SR United Kingdom or by e-mail from info@bonhams.com.

Notice to Bidders.

Clients are requested to provide photographic proof of ID - passport, driving licence, ID card, together with proof of address - utility bill, bank or credit card statement etc. Corporate clients should also provide a copy of their articles of association / company registration documents, together with a letter authorising the individual to bid on the company's behalf. Failure to provide this may result in your bids not being processed. For higher value lots you may also be asked to provide a bank reference.

If successful

I will collect the purchases myself

Please contact me with a shipping quote (if applicable)

Sale title: GOODWOOD FESTIVAL OF SPEED SALE		Sale date: 13 July 2018													
Sale no. 24876		Sale venue: Chichester, Sussex													
<p>If you are not attending the sale in person, please provide details of the Lots on which you wish to bid at least 24 hours prior to the sale. Bids will be rounded down to the nearest increment. Please refer to the Notice to Bidders in the catalogue for further information relating to Bonhams executing telephone, online or absentee bids on your behalf. Bonhams will endeavour to execute these bids on your behalf but will not be liable for any errors or failing to execute bids.</p> <p>General Bid Increments:</p> <table border="0"> <tr> <td>£10 - 200by 10s</td> <td>£10,000 - 20,000by 1,000s</td> </tr> <tr> <td>£200 - 500by 20 / 50 / 80s</td> <td>£20,000 - 50,000by 2,000 / 5,000 / 8,000s</td> </tr> <tr> <td>£500 - 1,000by 50s</td> <td>£50,000 - 100,000by 5,000s</td> </tr> <tr> <td>£1,000 - 2,000by 100s</td> <td>£100,000 - 200,000by 10,000s</td> </tr> <tr> <td>£2,000 - 5,000by 200 / 500 / 800s</td> <td>above £200,000at the auctioneer's discretion</td> </tr> <tr> <td>£5,000 - 10,000by 500s</td> <td></td> </tr> </table> <p>The auctioneer has discretion to split any bid at any time.</p>				£10 - 200by 10s	£10,000 - 20,000by 1,000s	£200 - 500by 20 / 50 / 80s	£20,000 - 50,000by 2,000 / 5,000 / 8,000s	£500 - 1,000by 50s	£50,000 - 100,000by 5,000s	£1,000 - 2,000by 100s	£100,000 - 200,000by 10,000s	£2,000 - 5,000by 200 / 500 / 800s	above £200,000at the auctioneer's discretion	£5,000 - 10,000by 500s	
£10 - 200by 10s	£10,000 - 20,000by 1,000s														
£200 - 500by 20 / 50 / 80s	£20,000 - 50,000by 2,000 / 5,000 / 8,000s														
£500 - 1,000by 50s	£50,000 - 100,000by 5,000s														
£1,000 - 2,000by 100s	£100,000 - 200,000by 10,000s														
£2,000 - 5,000by 200 / 500 / 800s	above £200,000at the auctioneer's discretion														
£5,000 - 10,000by 500s															
Customer Number		Title													
First Name		Last Name													
Company name (to be invoiced if applicable)															
Address															
City		County / State													
Post / Zip code		Country													
Telephone mobile		Telephone daytime													
Telephone evening		Fax													
Preferred number(s) in order for Telephone Bidding (inc. country code)															
E-mail (in capitals)															
By providing your email address above, you authorise Bonhams to send to this address information relating to Sales, marketing material and news concerning Bonhams. Bonhams does not sell or trade email addresses.															
I am registering to bid as a private buyer <input type="checkbox"/>		I am registering to bid as a trade buyer <input type="checkbox"/>													
If registered for VAT in the EU please enter your registration here: □□ / □□□ - □□□□ - □□		Please tick if you have registered with us before <input type="checkbox"/>													

Please note that all telephone calls are recorded.

Telephone or Absentee (T / A)	Lot no.	Brief description	MAX bid in GBP (excluding premium & VAT)	Covering bid *

FOR WINE SALES ONLY

Please leave lots "available under bond" in bond

Please include delivery charges (minimum charge of £20 + VAT)

BY SIGNING THIS FORM YOU AGREE THAT YOU HAVE SEEN THE CATALOGUE AND HAVE READ AND UNDERSTOOD OUR CONDITIONS OF SALE AND WISH TO BE BOUND BY THEM, AND AGREE TO PAY THE BUYER'S PREMIUM, VAT AND ANY OTHER CHARGES MENTIONED IN THE NOTICE TO BIDDERS. THIS AFFECTS YOUR LEGAL RIGHTS.

Your signature:

Date:

* Covering Bid: A maximum bid (exclusive of Buyers Premium and VAT) to be executed by Bonhams only if we are unable to contact you by telephone, or should the connection be lost during bidding.

NB. Payment will only be accepted from an account in the same name as shown on the invoice and Auction Registration form.

Please email or fax the completed Auction Registration form and requested information to:

Bonhams, Customer Services, 101 New Bond Street, London, W1S 1SR. Tel: +44 (0) 20 7447 7447 Fax: +44 (0) 20 7447 7401, bids@bonhams.com

Bonhams 1793 Limited. Montpelier Street, London SW7 1HH. Incorporated in England. Company Number 4326560.

UK/01/18

THE BONHAMS MOTORING NETWORK

UK (Head office)

101 New Bond Street
London, W1S 1SR
Tel: (020) 7447 7447
Fax: (020) 7447 7400

UK Representatives

County Durham
Stephen Cleminson
New Hummerbeck
Farm
West Auckland
Bishop Auckland
County Durham
DL14 9PQ
Tel: (01388) 832 329
stephen.cleminson@
bonhams.com

Cheshire & Staffordshire
Chris Shenton
Unit 1, Wilson Road
Hanford, Staffordshire
ST4 4QQ
Tel / Fax:
(01782) 643 159
chris.shenton@
bonhams.com

Devon, Cornwall & Somerset
Jonathan Vickers
Bonhams
36 Lemon Street
Truro, Cornwall
TR12NR
Tel: (01872) 250 170
Fax: (01872) 250 179
jonathan.vickers@
bonhams.com

Hampshire & Dorset
Michael Jackson
West Winds
Cupernham Lane
Romsey, Hants
SO51 7LE
Tel: (01794) 518 433
mike.jackson@
bonhams.com

Wiltshire, Hants, Glos, Berks & Somerset
Greg Pullen
Lower heath Ground
Easterton
Devizes
Wiltshire
SN10 4PX
Tel: (01380) 816 493
greg.pullen@
bonhams.com

Lincs & East Anglia Motorcycles
David Hawtin
The Willows
Church Lane
Swaby, Lincolnshire
LN13 0BQ
Tel /Fax:
(01507) 481 890
david.hawtin@
bonhams.com

Motor Cars
Robert Hadfield
95 Northorpe
Thurlby
Bourne
PE10 0HZ
Tel: 01778 426 417
Mob: 07539 074242
robert.hadfield@
bonhams.com

West Midlands & S. Wales
Bob Cordon-Champ
Highcliffe
2 Cherry Orchard
Lichfield, Staffordshire
WS14 9AN
Tel/fax: (01543) 411 154
robert.cordonchamp@
bonhams.com

Midlands Motor Cars
Richard Hudson-Evans
Po Box 4
Stratford-Upon-Avon
CV37 7YR
Tel: (01789) 414 983
richard.hudson-evans@
bonhams.com

Kent & Sussex
Colin Seeley
3 Whiteoak Gardens
The Hollies
Sidcup Kent
DA16 8WE
Tel: (020) 8302 7627
colin.seeley@
bonhams.com

Home Counties
David Hancock
5 Roscommon,
34 Brackendale Road,
Camberley,
Surrey,
GU15 2JR
(01276) 294 13
david.hancock@
bonhams.com

Herts, Beds, Bucks & Oxon
Martin Heckscher
April Cottage,
Cholesbury, near Tring,
HP23 6ND
Tel: (01494) 758 838
martin.heckscher@
bonhams.com

Lancs, Yorks, N. Counties & Scotland
Mark Garside
Knarr Mill
Oldham Road
Delph, Oldham
OL3 5RQ
Tel: (01457) 872 788
Mob: 07811 899 905
mark.garside@
bonhams.com

Lancs
Alan Whitehead
Pool Fold Farm
Church Road
Bolton,
BL1 5SA
Tel: (01204) 844 884
Fax: (01204) 401 799

Shropshire, Glos & Wales
Jim Reynolds
Childe Road
Cleobury Mortimer
Kidderminster
Shropshire
DY14 8PA
Tel: (01299) 270 642
jim.reynolds@
bonhams.com

Mike Worthington-
Williams
The Old School House
Cenarth
Newcastle Emlyn
Carmarthenshire
SA38 9JL
Tel: (01239) 711 486
(9am-5pm)
Fax: (01239) 711 367

European (Head office)

Paris
4 rue de la Paix
Paris
75002
Tel: +33 1 42 61 10 11
Fax: +33 1 42 61 10 15
eurocars@bonhams.com

European Representatives

Germany
Thomas Kamm
Maximilianstrasse 52
80538 Munich
Tel: +49 89 24 205812
Mob: +491716209930
Fax: +49 8924207523
thomas.kamm@
bonhams.com

Hans Schede
An St Swidbert 14
D-40489 Düsseldorf
Tel: +49 211 404202
Fax: +49 211 407764
hans.schede@
bonhams.com

Italy
Gregor Wenner
Tel: +39 049 651305
Mob: +39 333 564 3610
gregor.wenner@
bonhams.com

The Netherlands
Koen Samson
De Lairessestraat 154
1075 HH Amsterdam
The Netherlands
Tel: +31 20 67 09 701
Fax: +31 20 67 09 702
koen.samson@
bonhams.com

Norway / Sweden
Pascal Nyborg
Tel: +47 9342 2210

USA (Head offices)

San Francisco
Jakob Greisen
220 San Bruno Avenue
San Francisco,
CA 94103
Tel: +1 415 503 3353
Fax: +1 415 391 4040
motors.us@
bonhams.com

Los Angeles
Michael Caimano
7601 Sunset Boulevard
Los Angeles
CA 90046
Tel: +1 929 666 2243
Fax: +1 323 850 5843
michael.caimano@
bonhams.com

New York
Rupert Banner
580 Madison Avenue
New York, NY 10022
Tel: +1 212 461 6515
Fax: +1 917 206 1669
rupert.banner@
bonhams.com

USA Representatives

Southern California
464 Old Newport Blvd.
Newport Beach,
CA 92663
Tel: +1 949 646 6560
Fax: +1 949 646 1544

David Edwards
Tel: +1 949 460 3545
david.edwards@
bonhams.com

Midwest and East Coast
Evan Ide
78 Henry St
Uxbridge, MA 01569
Tel: +1 917 340 4657
evan.ide@
bonhams.com

Midwest
Tim Parker
Tel: +1 651 235 2776
tim.parker@
bonhams.com

Northwest
Tom Black
2400 N.E. Holladay
Portland, OR 97232
Tel: +1 503 239 0227

Pacific Northwest
Mark Osborne
5833 Stewart Glenn Ct
Lake Oswego, OR 97035
Tel: +1 415 518 0094
mark.osbourne@
bonhams.com

Southeast
Greg Porter
Tel: +1 336 406 6636
Greg.Porter@
bonhams.com

Rest of the World

Australia
97-99 Queen Street
Woollahra
Sydney NSW 2025
+61 2 8412 2222
+61 2 9475 4110 fax
info.au@bonhams.com

New Zealand
John Kennedy
Craighall
Puruatanga Road
Martinborough 5711
New Zealand
Tel: +64 6 306 8228
Mob: +64 21 042 5396
kaka943@icloud.com

Japan
Ryo Wakabayashi
Tokyo, Japan
+81 (0) 3 5532 8636
+81 (0) 3 5532 8637 fax
ryo.wakabayashi@
bonhams.com

Hong Kong
Suite 2001
One Pacific Place
88 Queensway
Admiralty
Hong Kong
+852 2918 4321
+852 2918 4320 fax
hongkong@bonhams.com

Beijing
Suite 511,
Chang An Club,
10 East Chang An Avenue,
Beijing 100006, China
Tel: +86 10 6528 0922
Fax: +86 10 6528 0933

Singapore
Bernadette Rankine
11th Floor, Wisma Atria
435 Orchard Road
Singapore 238877
+65 (0) 6701 8038
+65 (0) 6701 8001 fax
singapore@
bonhams.com

Bonhams Specialist Departments

To e-mail any of the below use the first name dot second name @bonhams.com eg. charles.obrien@bonhams.com

19th Century Paintings

UK
Charles O' Brien
+44 20 7468 8360
U.S.A
Madalina Lazen
+1 212 644 9108

20th Century British Art

Matthew Bradbury
+44 20 7468 8295

Aboriginal Art

Francesca Cavazzini
+61 2 8412 2222

African, Oceanic & Pre-Columbian Art

U.S.A
Fredric Backlar
+1 323 436 5416

American Paintings

Liz Goodridge
+1 917 206 1621

Antiquities

Francesca Hickin
+44 20 7468 8226

Antique Arms & Armour

UK
David Williams
+44 20 7393 3807
U.S.A
Paul Carella
+1 415 503 3360

Art Collections, Estates & Valuations

Harvey Cammell
+44 (0) 20 7468 8340

Art Nouveau & Decorative Art & Design

UK
Mark Oliver
+44 20 7393 3856
U.S.A
Benjamin Walker
+1 212 710 1306
Dan Tolson
+1 917 206 1611

Australian Art

Merryn Schriever
+61 2 8412 2222
Alex Clark
+61 3 8640 4088

Australian Colonial Furniture and Australiana

+61 2 8412 2222

Books, Maps & Manuscripts

UK
Matthew Haley
+44 20 7393 3817
U.S.A
Catherine Williamson
+1 323 436 5442

British & European Glass

UK
John Sandon
+44 20 7468 8244
U.S.A.
Suzy Pai
+1 415 503 3343

British Ceramics

UK
John Sandon
+44 20 7468 8244

California & American Paintings

Scot Levitt
+1 323 436 5425

Carpets

UK
carpets@bonhams.com
U.S.A.
+1 415 503 3392

Chinese & Asian Art

UK
Asaph Hyman
+44 20 7468 5888
U.S.A
Dessa Goddard
+1 415 503 3333
HONG KONG
Xibo Wang
+852 3607 0010
AUSTRALIA
Yvett Klein
+61 2 8412 2222

Clocks

UK
James Stratton
+44 20 7468 8364
U.S.A
Jonathan Snellenburg
+1 212 461 6530

Coins & Medals

UK
John Millensted
+44 20 7393 3914
U.S.A
Paul Song
+1 323 436 5455

Contemporary Art

UK
Ralph Taylor
+44 20 7447 7403
U.S.A
Jeremy Goldsmith
+1 917 206 1656

Entertainment Memorabilia

UK
Katherine Schofield
+44 20 7393 3871
U.S.A
Catherine Williamson
+1 323 436 5442

European Ceramics

UK
Sebastian Kuhn
+44 20 7468 8384
U.S.A
+1 415 503 3326

Furniture

UK
Thomas Moore
+44 20 8963 2816
U.S.A
Andrew Jones
+1 415 503 3413

European Sculptures & Works of Art

UK
Michael Lake
+44 20 8963 6813

Greek Art

Anastasia Orfanidou
+44 20 7468 8356

Golf Sporting Memorabilia

Kevin McGimpsey
+44 131 240 2296

Irish Art

Penny Day
+44 20 7468 8366

Impressionist & Modern Art

UK
India Phillips
+44 20 7468 8328
U.S.A
Nathania Nisonson
+1 917 206 1617

Indian, Himalayan & Southeast Asian Art

H.K.
Edward Wilkinson
+852 2918 4321
U.S.A
Mark Rasmussen
+1 917 206 1688

Islamic & Indian Art

Oliver White
+44 20 7468 8303

Japanese Art

UK
Suzannah Yip
+44 20 7468 8368
U.S.A
Jeff Olson
+1 212 461 6516

Jewellery

UK
Jean Ghika
+44 20 7468 8282
U.S.A
Caroline Morrissey
+1 212 644 9046
HONG KONG
Graeme Thompson
+852 3607 0006

Marine Art

UK
Veronique Scorer
+44 20 7393 3962

Mechanical Music

Jon Baddeley
+44 20 7393 3872

Modern, Contemporary & Latin American Art

U.S.A
Alexis Chompaisal
+1 323 436 5469

Modern & Contemporary Middle Eastern Art

Nima Sagharchi
+44 20 7468 8342

Modern & Contemporary South Asian Art

Tahmina Ghaffar
+44 207 468 8382

Modern Design

Gareth Williams
+44 20 7468 5879

Motor Cars

UK
Tim Schofield
+44 20 7468 5804
U.S.A
Mark Osborne
+1 415 503 3353
EUROPE
Philip Kantor
+32 476 879 471

Automobilia

UK
Toby Wilson
+44 8700 273 619
Adrian Pipiros
+44 8700 273621

Motorcycles

Ben Walker
+44 8700 273616

Native American Art

Ingmars Lindbergs
+1 415 503 3393

Natural History

U.S.A
Claudia Florian
+1 323 436 5437

Old Master Pictures

UK
Andrew Mckenzie
+44 20 7468 8261
U.S.A
Mark Fisher
+1 323 436 5488

Orientalist Art

Charles O'Brien
+44 20 7468 8360

Photography

U.S.A
Laura Paterson
+1 917 206 1653

Prints and Multiples

UK
Lucia Tro Santafe
+44 20 7468 8262
U.S.A
Morisa Rosenberg
+1 323 447 9374

Russian Art

UK
Daria Chernenko
+44 20 7468 8334
U.S.A
Yelena Harbick
+1 212 644 9136

Scientific Instruments

Jon Baddeley
+44 20 7393 3872
U.S.A.
Jonathan Snellenburg
+1 212 461 6530

Scottish Pictures

Chris Brickley
+44 131 240 2297

Silver & Gold Boxes

UK
Ellis Finch
+44 20 7393 3973
U.S.A
Aileen Ward
+1 323 436 5463

South African Art

Giles Peppiatt
+44 20 7468 8355

Sporting Guns

Patrick Hawes
+44 20 7393 3815

Travel Pictures

Veronique Scorer
+44 20 7393 3962

Urban Art

Gareth Williams
+44 20 7468 5879

Watches & Wristwatches

UK
Jonathan Darracott
+44 20 7447 7412
U.S.A.
Jonathan Snellenburg
+1 212 461 6530
H.K.
Tim Bourne
+852 3607 0021

Whisky

UK
Martin Green
+44 131 225 2266
HONG KONG
Daniel Lam
+852 2918 4321

Wine

UK
Richard Harvey
+44 20 7468 5811
U.S.A
Erin McGrath
+1 415 503 3319
HONG KONG
Daniel Lam
+852 2918 4321

UNITED KINGDOM

London
101 New Bond Street ●
London W1S 1SR
+44 20 7447 7447
+44 20 7447 7400 fax

Montpelier Street ●
London SW7 1HH
+44 20 7393 3900
+44 20 7393 3905 fax

South East England

Guildford
Millmead,
Guildford,
Surrey GU2 4BE
+44 1483 504 030
+44 1483 450 205 fax

Isle of Wight

+44 1273 220 000

Representative:
Brighton & Hove
Tim Squire-Sanders
+44 1273 220 000

West Sussex

+44 (0) 1273 220 000

South West England

Bath
Queen Square House
Charlotte Street
Bath BA1 2LL
+44 1225 788 988
+44 1225 446 675 fax

Cornwall – Truro

36 Lemon Street
Truro
Cornwall
TR1 2NR
+44 1872 250 170
+44 1872 250 179 fax

Exeter
The Lodge
Southernhay West Exeter,
Devon
EX1 1JG
+44 1392 425 264
+44 1392 494 561 fax

Tetbury
Eight Bells House
14 Church Street
Tetbury
Gloucestershire
GL8 8JG
+44 1666 502 200
+44 1666 505 107 fax

Representatives:
Dorset
Bill Allan
+44 1935 815 271

East Anglia and Bury St. Edmunds
Michael Steel
+44 1284 716 190

Norfolk
The Market Place
Reepham
Norfolk NR10 4JJ
+44 1603 871 443
+44 1603 872 973 fax

Midlands

Knowle
The Old House
Station Road
Knowle, Solihull
West Midlands
B93 0HT
+44 1564 776 151
+44 1564 778 069 fax

Oxford
Banbury Road
Shipton on Cherwell
Kidlington OX5 1JH
+44 1865 853 640
+44 1865 372 722 fax

Yorkshire & North East England

Leeds
The West Wing
Bowcliffe Hall
Bramham
Leeds
LS23 6LP
+44 113 234 5755
+44 113 244 3910 fax

North West England

Chester
2 St Johns Court,
Vicars Lane,
Chester,
CH1 1QE
+44 1244 313 936
+44 1244 340 028 fax

Manchester
The Stables
213 Ashley Road
Hale WA15 9TB
+44 161 927 3822
+44 161 927 3824 fax

Channel Islands

Jersey
La Chasse
La Rue de la Vallee
St Mary
Jersey JE3 3DL
+44 1534 722 441
+44 1534 759 354 fax

Representative:
Guernsey
+44 1481 722 448

Scotland

Edinburgh ●
22 Queen Street
Edinburgh
EH2 1JX
+44 131 225 2266
+44 131 220 2547 fax

Bonhams West of Scotland
Kirkhill House
Broom Road East
Newton Mearns
Glasgow
G77 5LL
+44 141 223 8866

Wales

Representatives:
Cardiff
Jeff Muse
+44 2920 727 980

EUROPE

Austria
Thomas Kamm
+49 (0) 89 2420 5812
austria@bonhams.com

Belgium
Boulevard
Saint-Michel 101
1040 Brussels
+32 (0) 2 736 5076
belgium@bonhams.com

France
4 rue de la Paix
75002 Paris
+33 (0) 1 42 61 10 10
paris@bonhams.com

Germany - Cologne
Katharina Schmid
+49 (0) 221 9865 3419
+49 (0) 157 9234 6717
cologne@bonhams.com

Germany - Munich
Maximilianstrasse 52
80538 Munich
+49 (0) 89 2420 5812
munich@bonhams.com

Germany - Stuttgart
Neue Brücke 2
New Bridge Offices
70173 Stuttgart
+49 (0) 711 2195 2640
+49 (0) 157 9234 6717
stuttgart@bonhams.com

Greece
7 Neofytou Vamva Street
Athens 10674
+30 (0) 210 3636 404
athens@bonhams.com

Ireland
31 Molesworth Street
Dublin 2
+353 (0) 1 602 0990
ireland@bonhams.com

Italy - Milan
Via Boccaccio 22
20123 Milano
+39 0 2 4953 9020
milan@bonhams.com

Italy - Rome
Via Sicilia 50
00187 Roma
+39 06 485 900
rome@bonhams.com

The Netherlands
De Lairesestraat 154
1075 HL Amsterdam
+31 (0) 20 67 09 701
amsterdam@bonhams.com

Portugal
Rua Bartolomeu Dias
n°160. 1°
Belem
1400-031 Lisbon
+351 218 293 291
portugal@bonhams.com

Spain - Barcelona
Teresa Ybarra
+34 930 156 686
+34 680 347 606
barcelona@bonhams.com

Spain - Madrid
Núñez de Balboa no 4-1C
28001 Madrid
+34 915 78 17 27
madrid@bonhams.com

Sweden
Ingrid Bjäringer
+46 (0)709 79 90 07
sweden@bonhams.com

Switzerland - Geneva
Rue Etienne-Dumont 10
1204 Geneva
+41 (0) 22 300 3160
geneva@bonhams.com

Switzerland - Zurich
Andrea Bodmer
Dreikönigstrasse 31a
8002 Zürich
+41 44 281 9535
zurich@bonhams.com

MIDDLE EAST

Israel
Joslyne Halibard
+972 (0)54 553 5337
joslyne.halibard@
bonhams.com

NORTH AMERICA

USA

San Francisco ●
220 San Bruno Avenue
San Francisco
CA 94103
+1 (415) 861 7500
+1 (415) 861 8951 fax

Los Angeles ●
7601 W. Sunset Boulevard
Los Angeles
CA 90046
+1 (323) 850 7500
+1 (323) 850 6090 fax

New York ●
580 Madison Avenue
New York, NY
10022
+1 (212) 644 9001
+1 (212) 644 9007 fax

Representatives:
Arizona
Terri Adrian-Hardy
+1 (602) 859 1843
arizona@bonhams.com

California
Central Valley
David Daniel
+1 (916) 364 1645
sacramento@bonhams.com

California
Palm Springs
Brooke Sivo
+1 (760) 350 4255
palm Springs@bonhams.com

California
San Diego
Brooke Sivo
+1 (760) 567 1744
sandiego@bonhams.com

Colorado
Lance Vigil
+1 (720) 355 3737
colorado@bonhams.com

Florida
April Matteini
+1 (305) 978 2459
florida@bonhams.com

Georgia

Mary Moore Bethea
+1 (404) 842 1500
georgia@bonhams.com

Illinois
Ricki Blumberg Harris
+1 (773) 267 3300
chicago@bonhams.com

Massachusetts
Amy Corcoran
+1 (617) 742 0909
boston@bonhams.com

Nevada
David Daniel
+1 (775) 831 0330
nevada@bonhams.com

New Mexico
Terri Adrian-Hardy
+1 (617) 859 1843
newmexico@bonhams.com

Oregon
Sheryl Acheson
+1 (971) 727 7797
oregon@bonhams.com

Texas
Amy Lawch
+1 (713) 621 5988
texas@bonhams.com

Virginia
Gertraud Hechl
+1 (202) 422 2733
virgina@bonhams.com

Washington
Heather O'Mahony
+1 (206) 566 3913
seattle@bonhams.com

Washington DC
Mid-Atlantic Region
Gertraud Hechl
+1 (202) 422 2733
washingtonDC
@bonhams.com

CANADA

Toronto, Ontario ●
Kristin Kearney
340 King St East
2nd Floor, Office 213
Toronto ON
M5A 1K8
+1 (416) 462 9004
info.ca@bonhams.com

Montreal, Quebec
David Kelsey
+1 (514) 894 1138
info.ca@bonhams.com

SOUTH AMERICA

Brazil
+55 11 3031 4444
+55 11 3031 4444 fax

ASIA

Hong Kong ●
Suite 2001
One Pacific Place
88 Queensway
Admiralty
Hong Kong
+852 2918 4321
+852 2918 4320 fax
hongkong@bonhams.com

Beijing
Jessica Zhang
Suite 511
Chang An Club
10 East Chang An Avenue
Beijing 100006
+86(0) 10 6528 0922
+86(0) 10 6528 0933 fax
beijing@bonhams.com

Singapore
Bernadette Rankine
11th Floor, Wisma Atria
435 Orchard Road
Singapore 238877
+65 (0) 6701 8038
+65 (0) 6701 8001 fax
bernadette.rankine@
bonhams.com

Taiwan
37th Floor, Taipei 101 Tower
No. 7 Xinyi Road, Section 5
Taipei, 100
+886 2 8758 2898
+886 2 8758 2897 fax
taiwan@bonhams.com

AUSTRALIA

Sydney
97-99 Queen Street,
Woollahra, NSW 2025
Australia
+61 (0) 2 8412 2222
+61 (0) 2 9475 4110 fax
info.aus@bonhams.com

Melbourne
Como House
Como Avenue
South Yarra
Melbourne VIC 3141
Australia
+61 (0) 3 8640 4088
+61 (0) 2 9475 4110 fax
info.aus@bonhams.com

AFRICA

Nigeria
Neil Coventry
+234 (0)8110 033 792
+27 (0)7611 20171
neil.coventry@bonhams.com

South Africa - Johannesburg
Penny Culverwell
+27 (0)71 342 2670
penny.culverwell@bonhams.com



The Endurance Rally Association
Home of the Peking to Paris Rally



Ready for a new adventure Entries now open



Adriatic Adventure, 18 to 29 September 2019

This brand new event will mirror the Baltic Classic in style and take competitors into countries that are new territory for 12-days of rallying. Starting and finishing in Trieste, we go from the mountains of the inland Balkans to the dazzling brilliance of the Adriatic coastline.



Rally New Zealand, 15 February to 8 March 2020

The ERA makes its first journey to New Zealand with a spectacular route planned to showcase this amazing country. Starting from Auckland, our crews will enjoy a fabulous mix of gravel tests, forest regularities, race circuits and undiscovered delights as we rally to Christchurch.

Open to pre-1976 cars.

Contact the Rally Office to request a brochure and more details.

 tel: +44 (0)1235 831221 email: admin@endurorally.com
 www.endurorally.com

Supported by:

Bonhams

THE VINTAGE SPORTS-CAR CLUB PRESENTS

PRESCOTT VINTAGE SPEED HILL CLIMB

VSCC SPEED CHAMPIONSHIP ROUND 5



WEEKEND 4/5 AUG 2018

**PRESCOTT HILL, NR CHELTENHAM
GLOUCESTERSHIRE**

TICKETS

ADVANCE BOOKINGS

VSCC MEMBERS SAT £15 / SUN £15 / WEEKEND £25

GENERAL PUBLIC SAT £20 / SUN £20 / WEEKEND £30

BOOK AT vsc.co.uk OR CALL 01608 644999

ON THE DAY SAT £25 / SUN £25 / WEEKEND £40

U16s FREE ENTRY

www.VSCC.co.uk



**PRESCOTT
SPEED HILL CLIMB**



PRINCIPAL ASSOCIATES:

Bonhams

HAGERTY
CLASSIC CAR INSURANCE



Index

Lot	Year	Model	Lot	Year	Model
339	1936	AC 16/70hp March Special Sports Tourer	374	1991	Ferrari Testarossa Coupé
354	1954	AC Ace Roadster	385	1997	Ferrari 550 Maranello Coupé
366	1929	Alfa Romeo 6C 1500 Sport Tourer	368	2003	Ferrari 575 Maranello F1 Coupé
366A	c. 1930	Alfa Romeo 6C 1750 Engine	373	1965	Ford Lotus Cortina MkI Competition Saloon
366B	c. 1930	Alfa Romeo 6C 1750 Gearbox	331	1965	Ford Lotus Cortina MkI Competition Saloon
352	1932-34	Alfa Romeo Tipo B Grand Prix Monoposto	351	1967	Ford Lotus Cortina MkII Competition Saloon
309	1962	Alfa Romeo Giulia Sprint Coupé	361	1951	Jaguar XK120 3.8-Litre Roadster
305	1964	Alfa Romeo Giulia 1600 Spider	386	1955	Jaguar XK140 Drophead Coupé
387	1959	Alfa Romeo 2000 Spider	364	1956	Jaguar XK140 Coupé
324		Aston Martin 4-Litre Engine	332	1961	Jaguar E-Type Series I 'Flat Floor' 3.8-Litre Roadster
357	1960	Aston Martin DB4 GT	345	1961	Jaguar E-Type Series I 'Flat Floor' 3.8-Litre Roadster
335	1961	Aston Martin 'MP209' DB4GT Zagato	377	1970	Jaguar E-Type Series II Roadster
312	1964	Aston Martin DB5 4.3-Litre Sports Saloon	381	2010	Jaguar XJ8 LWB 'Armoured' Saloon
370	1965	Aston Martin DB5 Sports Saloon	341	1968	Jensen FF MkI Coupé
314	1967	Aston Martin DB6 4.5-Litre Sports Saloon	371	2009	Lamborghini Murciélago LP 670-4 Super Veloce Coupé
337	1967	Aston Martin DB6 Vantage Volante	355	1954	Lancia Appia Saloon
358	1989	Aston Martin V8 Vantage 'X-Pack' Sports Saloon	320	1963	Land Rover 80" Series I 4x4 Utility
356	2007	Aston Martin V12 Vantage RS Coupé Prototype	310	1985	Land Rover 90 V8 4x4 Utility
349	2011	Aston Martin One-77 Q-Series Coupé	379	2014	Land Rover Defender SVX 'Spectre' 4x4 Utility
318	2017	Aston Martin Vanquish S Coupé	321	2015	Land Rover Defender 110 XS Double Cab 4x4 Pickup
344	1955	Austin-Healey 100S Sports Racing Two-Seater	336	1984	March 84G-Chevrolet Group C/GTP Sports Prototype
353	1926	Bentley 3-Litre Speed Model Sports Tourer	367	1936	Marendaz Special 13/70hp Sports Tourer
369	1928	Bentley 4½-Litre Tourer	346	2012	McLaren MP4-12C Coupé
340	1929	Bentley Speed Six 'Le Mans Replica' Tourer	347	2014	McLaren P1 Coupé
359	1931	Bentley 4½-Litre Supercharged Tourer	329	1953	Mercedes-Benz 300 Cabriolet
328	1951	Bentley R-Type Continental Sports Saloon	380	1958	Mercedes-Benz 220SE 'Ponton' Competition Saloon
383	1964	Bentley Series 3 Continental Two Door Saloon	382	1962	Mercedes-Benz 190 SL Roadster
330	1957	BMW 507 Roadster with Hardtop	362	1964	Mercedes-Benz 300SE 'Fintail' Competition Saloon
323		Brian James A4 Car Transporter Trailer	302	2018	Mini Cooper 'S' 3-Door Hatch
325	1935	Brough Superior 4.2-Litre Drophead Coupé	363	1959	Morgan Plus 4 2.1-Litre Competition Roadster
327	1937	Brough Superior 3½-Litre Saloon	388	1965	Morris Mini Cooper 970 'S' Sports Saloon
326	1938	Brough Superior 4½-Litre V12 Sports Saloon	378	2016	Pagani Huayra Coupé
350	1928	Bugatti Type 40 Grand Sport	319	1972	Porsche 911S 2.4-Litre Coupé
308	1928	Bugatti Type 44 Tourer	301	1977	Porsche 911S Coupé
348	2012	Bugatti Veyron Super Sport Coupé	384	1995	Porsche 911 Type 993 Carrera Cup Competition Coupé
343	1968	Chevron B8 Coupé	333	1996	Porsche 911 Type 993 Turbo Coupé
304	1981	DeLorean DMC12 Coupé	376	2005	Porsche 911 Type 996 Turbo S Coupé
342	1960	Ferrari 250 GT Coupé	375	2007	Porsche 911 Type 997 Turbo S Cabriolet
317	1964	Ferrari 330 GT 2+2 'Series 1' Coupé	311	1972	Range Rover 4x4 Estate
338	1970	Ferrari 365 GTB/4 'Daytona' Berlinetta	306	1920	Rolls-Royce 40/50hp Silver Ghost Alpine Eagle Tourer
334	1972	Ferrari Dino 246 GT Berlinetta Project	322	2018	Rolls-Royce Dawn Convertible
307	1973	Ferrari Dino 246 GTS	315	1967	Sunbeam Alpine Series V Roadster
365	1973	Ferrari Dino 246 GT Berlinetta	303	1969	Triumph TR6 Roadster
372	1981	Ferrari 208 GTB Coupé	316	1972	TVR Vixen S3 Coupé
360	1985	Ferrari 308 GTS Quattrovalvole Targa Coupé			



£ 1793

Bonhams

101 New Bond Street
London
W1S 1SR

+44 (0) 20 7447 7447
+44 (0) 20 7447 7400 fax



International Auctioneers and Valuers – bonhams.com/cars



presented by



mastercard